

The background of the entire page is a photograph of a modern building with large windows and a facade of grey panels. In the foreground, there are lush green trees and bushes, some of which are out of focus, creating a sense of depth and a connection to nature. The overall lighting is bright and sunny, suggesting a clear day.

Vent-Axia[®]

Improving Indoor Air Quality since 1936

Vent-Axia Sentinel Apex

Edition 1

www.vent-axia.com/apex



HELPING YOU TO ACHIEVE YOUR SUSTAINABILITY GOALS

Addressing economic, social and environmental challenges is a priority high on everyone's agenda. The need to foster positive workplaces, achieve net-zero emissions, combat climate change and promote environmental regeneration is more urgent than ever before. Change is inevitable.

Regardless of the size of your organisation or project, we can assist you in achieving your sustainability objectives. Whether you are starting your sustainability journey or require additional support to move forward, we can help you achieve your goals in several ways.

- **Energy efficiency:** We can provide energy-efficient ventilation systems that consume less energy than traditional systems. By using less energy, you can reduce your carbon footprint and save on energy costs.
- **Sustainable materials:** We are committed to using sustainable materials in our products, such as recycled plastic and low-emission materials. By using sustainable materials, you can reduce your environmental impact.

- **Indoor air quality:** We can help improve indoor air quality by providing ventilation systems that reduce the presence of harmful pollutants and allergens in the air. This can lead to a healthier work environment for employees, which can in turn increase productivity and reduce healthcare costs
- **Life-cycle analysis:** We conduct a life-cycle analysis of our products, which includes the manufacturing, use and disposal phases. This analysis can help identify areas where the product can be made more sustainable and reduce the overall environmental impact.

Improving Indoor Air Quality, Sustainability - by choosing a Vent-Axia solution ensures you are purchasing a product designed and manufactured in the UK, reducing your environmental impact, and improving your financial performance through energy savings and improved indoor air quality.



EMBODIED CARBON DATA

When designing a building to be low carbon or carbon-neutral, there are many challenges to consider, from selecting materials to coordinating multiple layers of supply chain management. Obtaining accurate and up-to-date embodied carbon information is crucial for ensuring that the building meets its carbon reduction targets. However, this can be a time-consuming and complex process, as it requires data to be collected from multiple sources, including suppliers, manufacturers and contractors.

At Vent-Axia, we understand the challenges that come with designing low-carbon buildings, which is why we want to make things as easy as possible for you. We recognise that embodied carbon data can be difficult to obtain and that is why we have taken additional steps to provide accurate and reliable information.

Our Vent-Axia Sentinel Apex has been designed to have a low embodied carbon footprint. We have used the CIBSE TM65 data collection methodology to collect accurate and detailed embodied carbon information for the Sentinel Apex. This methodology ensures that our data is comprehensive, reliable and up-to-date, making it easier for you to focus on what is really important - designing buildings that are low carbon and environmentally sustainable.

By providing this valuable data, we hope to make it easier for you to design and construct buildings that are not only energy-efficient but also have a low carbon footprint. We believe that by working together, we can help to create a more sustainable built environment, one that is not only environmentally responsible but also economically and socially beneficial for all stakeholders involved.



70% sales revenue from **low-carbon products** by FY2025

90% target for **recycled plastics** for manufactured products by 2025

THE NEED TO RECOVER ENERGY

Rising prices place an increasing pressure on organisations driving them to seek reductions in energy consumption, without adversely impacting the indoor air quality (IAQ) and thermal comfort of the building.

The high-efficiency cell incorporated within the Sentinel Apex range achieves a market leading 93% thermal efficiency (EN308 tested). This high level of efficiency means that the heating and cooling energy lost through ventilation can be reduced by up to 25% when compared to a 73% efficient heat exchanger in both heating and cooling seasons. This high efficiency also means that expensive after heaters, often required in lower efficiency heat recovery devices, may not now be required.

- ✓ High efficiency heat exchanger - up to 93% energy recovery
- ✓ Bypass designed to eliminate additional pressure loss / power consumption whilst in operation
- ✓ Integral automatic summer bypass - providing free cooling during summer
- ✓ Double skin construction for class leading acoustic properties
- ✓ Energy efficient EC/DC motors - 1/3 less energy lost to heat than a conventional AC motor
- ✓ Motor efficiency equivalent to better than IE5



THE NEED FOR BETTER INDOOR AIR QUALITY

Removal of pollutants, such as moisture, carbon dioxide and external fumes are all important factors in maintaining indoor air quality. A study cited in the new Approved Document F* indicates that CO₂ levels building up in a room can indicate poor indoor air quality (IAQ). This is why CO₂ is now recommended as a method of measuring the air quality in occupiable rooms in non-residential buildings. In addition, studies within schools have demonstrated that maintaining lower carbon dioxide levels helps create a better learning environment leading to higher student attainment. Approved Document F now states that occupied rooms in commercial buildings must have means of monitoring IAQ levels. CO₂ demand controlled ventilation can ensure good air quality as per Part F.

- ✓ Hierarchical control maintains CO₂ levels within levels described in Approved Document F Volume 2 and Building Bulletin 101
- ✓ Fully modular range of compatible air quality sensors including: CO₂, Temperature & Humidity and TVOC
- ✓ Demand control optimising indoor air quality whilst minimising ventilation energy consumption
- ✓ Closed loop control system ensures maximum comfort levels at minimum energy levels
- ✓ Class leading ultra-low sound levels exceeding requirements of Building Design

*Application of CO₂ monitoring as an approach to managing ventilation to mitigate SARS-COV-2 transmission



THE NEED TO MEET LEGISLATION

You can rest assured that when it comes to regulations, we have got all the bases covered. Our Sentinel Apex is fully compliant with both Part F and L requirements and has been specifically designed to delivery excellent performance in the energy efficiency and thermal comfort requirements of BB101 for schools.

- ✓ Meets the requirement of Approved Documents F & L 2021 edition performance and specific fan power requirements
- ✓ Market leading 93% heat exchange efficiency tested to EN 308
- ✓ Extremely low noise levels to comply with BB93 (independently tested by SRL)
- ✓ Meets the requirements for BB101 for use in schools
- ✓ Embodied carbon data and BIM Revit models available
- ✓ Lowest Specific Fan Power figures of any high efficiency D-ERV product
- ✓ With CO₂ control via nondispersive CO₂ sensors, we are able to help you achieve the new IAQ targets set out in Approved Document F



SENTINEL APEX

Simply More as Standard

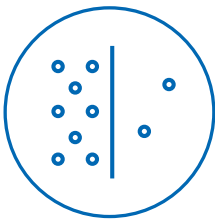

High-Spec

Removal of pollutants such as carbon dioxide and external fumes with supply filter.

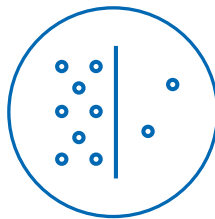

Improved IAQ

Supplying fresh, healthy, filtered air providing improved and better indoor air quality.

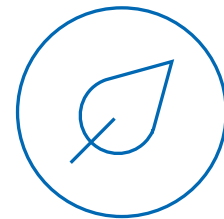

Energy Efficient

Market leading SFP's with up to 93% energy recovery.



Commercial Heat Recovery - Helping you create a low-carbon future, today.

Commercial Heat Recovery is at the forefront of offering a transformative way to embrace a low-carbon future. By harnessing wasted heat, this technology ensures that energy is not squandered but rather reused efficiently.

We work closely with clients, understanding their requirements, and designing tailored solutions that maximize efficiency and minimize environmental impact. From initial assessment to installation and ongoing maintenance, we provide comprehensive support throughout the entire process.

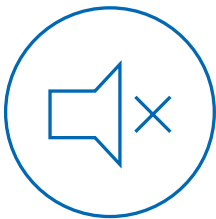

Leading SFP & Low Noise Levels

Market leading performance on SFP and double skinned panels for better sound insulation.



TM65 Embodied Carbon

Embodied carbon data available using the CIBSE TM65 data collection methodology.



Range of Sizes

Five sizes available in the range, delivering airflows up to e4000m³/h.



5-year parts warranty

Backed with a 5-year parts warranty and supported with a comprehensive spare parts list, our Sentinel Apex is designed for effortless maintenance and will stand the test of time.

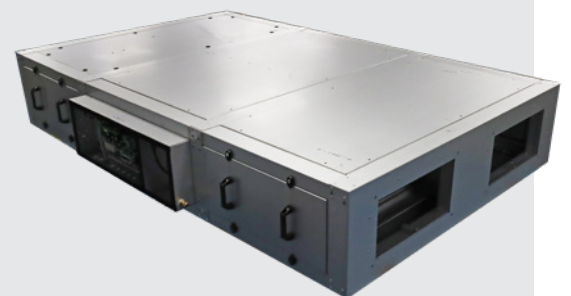

SENTINEL APEX COMMERCIAL HEAT RECOVERY RANGE

The Sentinel Apex range is the next generation in commercial heat recovery systems. Designed to supply the indoor environment with fresh, healthy, filtered air providing improved air quality, while maintaining exceptional energy recovery, market leading Specific Fan Power (SFP) and low noise levels.

With five sizes in the range, delivering airflows up to 4000m³/h, there is a solution for all your project requirements. In various settings such as schools, offices, hotels and restaurants, the focus is on enhancing indoor air quality and comfort for the well-being of the occupants, while also aiming to reduce energy consumption and lower running costs.

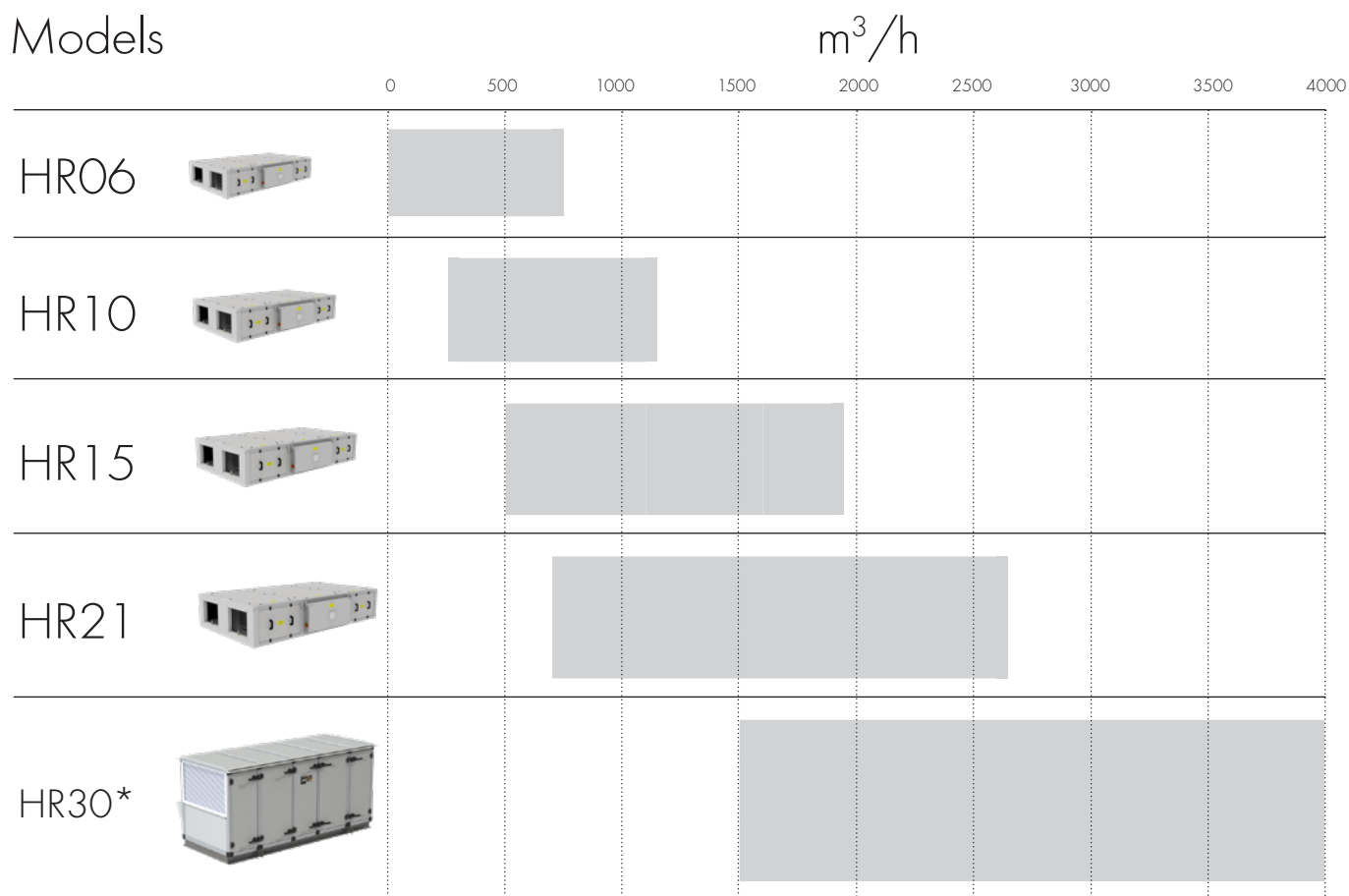

*Technical data and product detail available on application

What is Heat Recovery?

Heat Recovery Ventilation units also known as Mechanical Ventilation Heat Recovery (MVHR) are supply and extract systems which are the ideal solution where the need to recover energy and supply the indoor environment with fresh, healthy, filtered air while extracting stale air.

Heat recovery systems typically recover about 60-95% of the heat in exhaust air and have significantly improved the energy efficiency of buildings, we can offer low-energy solutions for every commercial application, all manufactured in the UK to the highest standards.

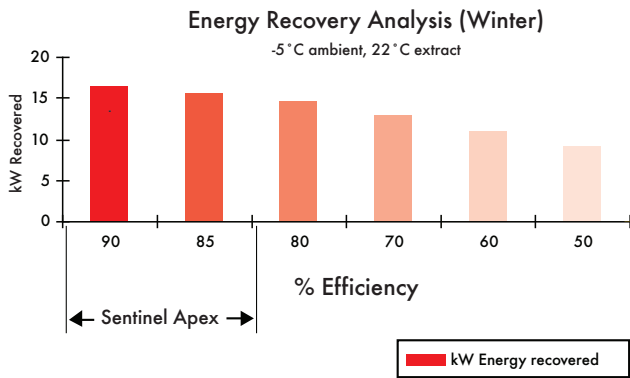
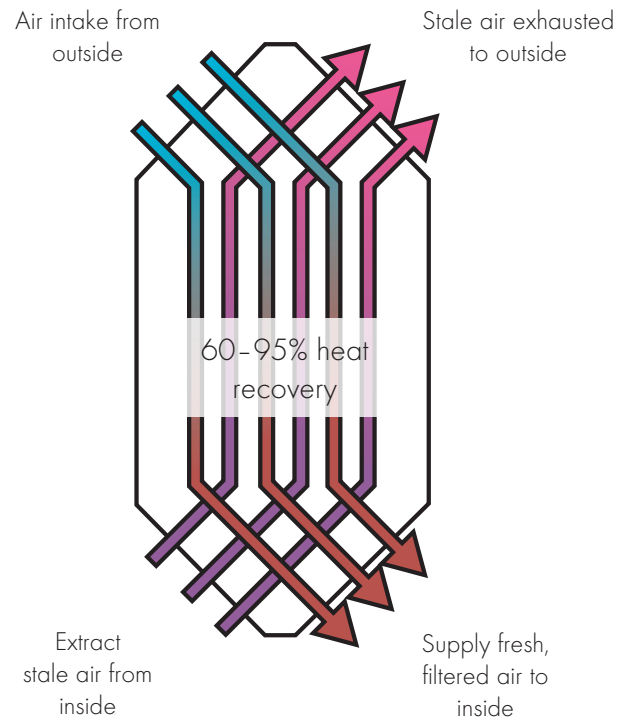

Airflow m ³ /s	Efficiency %	kW Heat recovered	Supply temp °C
0.555	90	16.51	19.3
	85	15.59	18.0
	80	14.67	16.6
	70	12.84	13.9
	60	11.00	11.2
	50	9.17	8.5

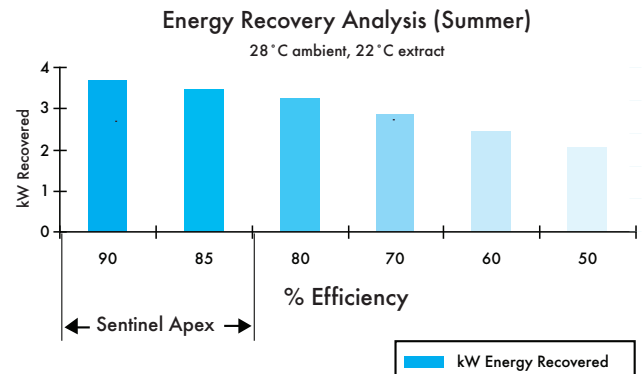

Airflow m ³ /s	Efficiency %	kW Cool Recovered	Supply temp °C
0.555	90	3.67	22.6
	85	3.46	22.9
	80	3.26	23.2
	70	2.85	23.8
	60	2.45	24.4
	50	2.04	25.0



VERSATILE APPLICATION

Ideal for applications where the rooms are used at different times of the day by a variable number of people, the Sentinel Apex system will monitor occupancy, ventilation rate and air quality, and respond accordingly to maintain the atmosphere within preset limits, recovering up to 93% of extracted energy.

Typical applications include:

- ✓ A network of hotel bathrooms, flats or apartments, which require ventilation but are only used for limited periods particularly in the morning and evening.
- ✓ School classrooms and lecture theatres, which are only occupied during lesson time by a variable number of students, but when used must keep CO₂ levels within prescribed limits.
- ✓ Office meeting rooms or open plan areas which, are used periodically during the day by a variable number of staff and visitors, but when occupied must meet required airflow rates.

Automatic sensing and control runs the system according to the maximum demand requirements of the building zone, whether it be carbon dioxide levels, temperature, humidity or air quality - triggered by people entering or leaving the rooms. Common configurations include Electronic Static Pressure (ESP) controllers for constant pressure systems.





Compliant with Part F & L of the Building Regulations



Compliant with BB101



Compliant with the schools outputs specifications, 2F & 2J



Compliant with PPN 06/21

Carbon Dioxide Guidance

Studies have shown that CO₂ can be harmful to health, as well as reducing focus and attention. This can be especially damaging to students, when in a classroom of up to 32 people or in small office spaces with a high number of staff. If ventilation is not sufficient, the CO₂ levels can rise quickly. In BB101 guidance, an average of 1000PPM is required to be maintained when mechanical ventilation is installed providing a healthy environment for students, teachers and office staff.

The Vent-Axia Sentinel Apex can provide closed loop CO₂ control to maintain levels below the required targets from the BB101 guidance.

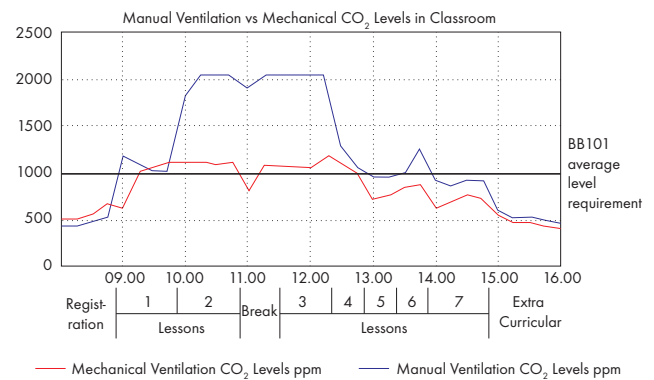

MECHANICAL SYSTEM OVERVIEW

Access Points

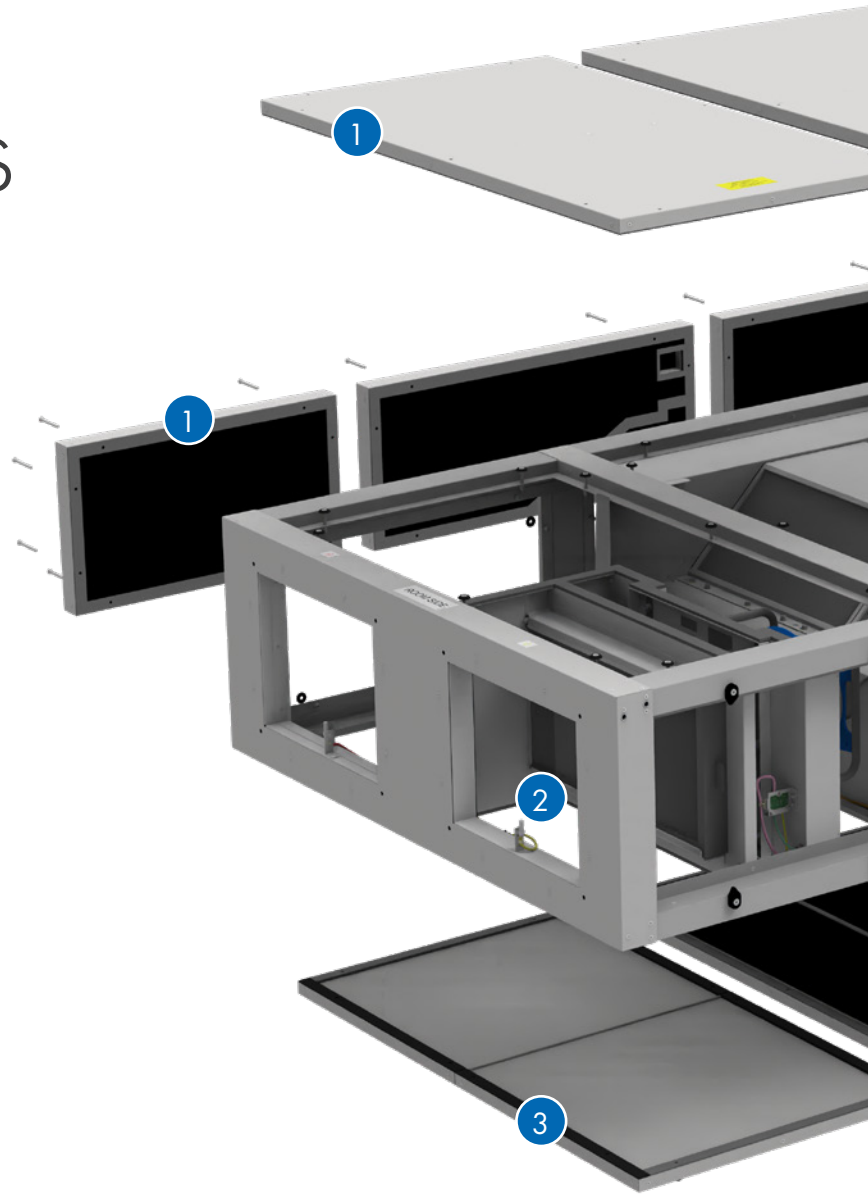

1

Top and Side Panels

Top and reverse side panel fixed, but can be removed for full access to all internal components.

2

Extract Air Filter

ePM10 50% (M5 equivalent) extract filter.

3

Bottom Panels

Bottom access panels removable for filter and motor access.

4

Fitted Isolator

Fitted lockable mains isolator.

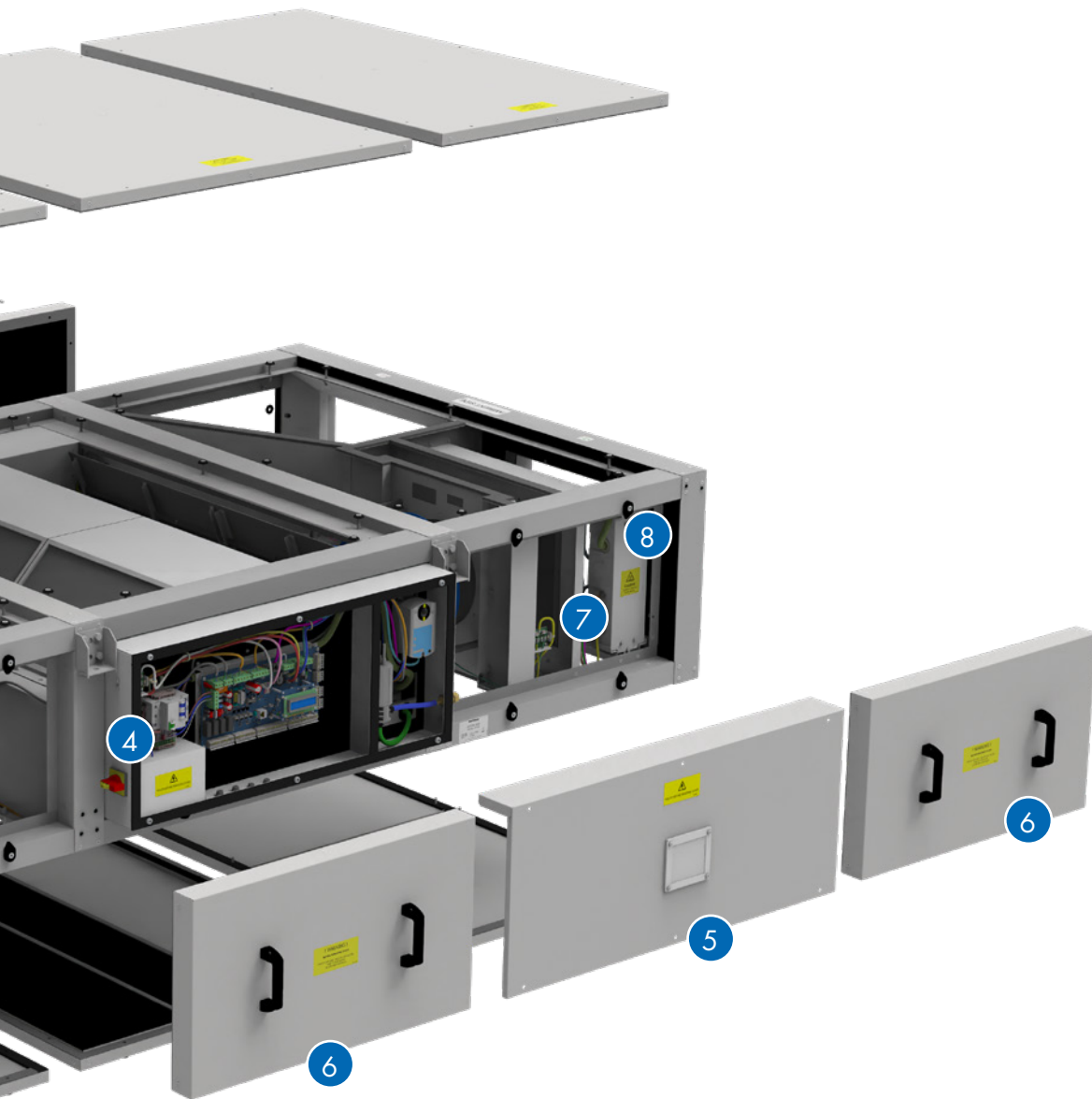

5

Control Cover

Removal cover for wiring control panel accessible without removing panel.

6

Side Panels

Removable side access panels for filter and motor access.

7

Supply Air Filter

ePM1 70% (F7 equivalent) supply filter.

8

Anti-Frost Heater

Integral electric anti-frost heater.

MECHANICAL SYSTEM OVERVIEW

Mechanical Accessories

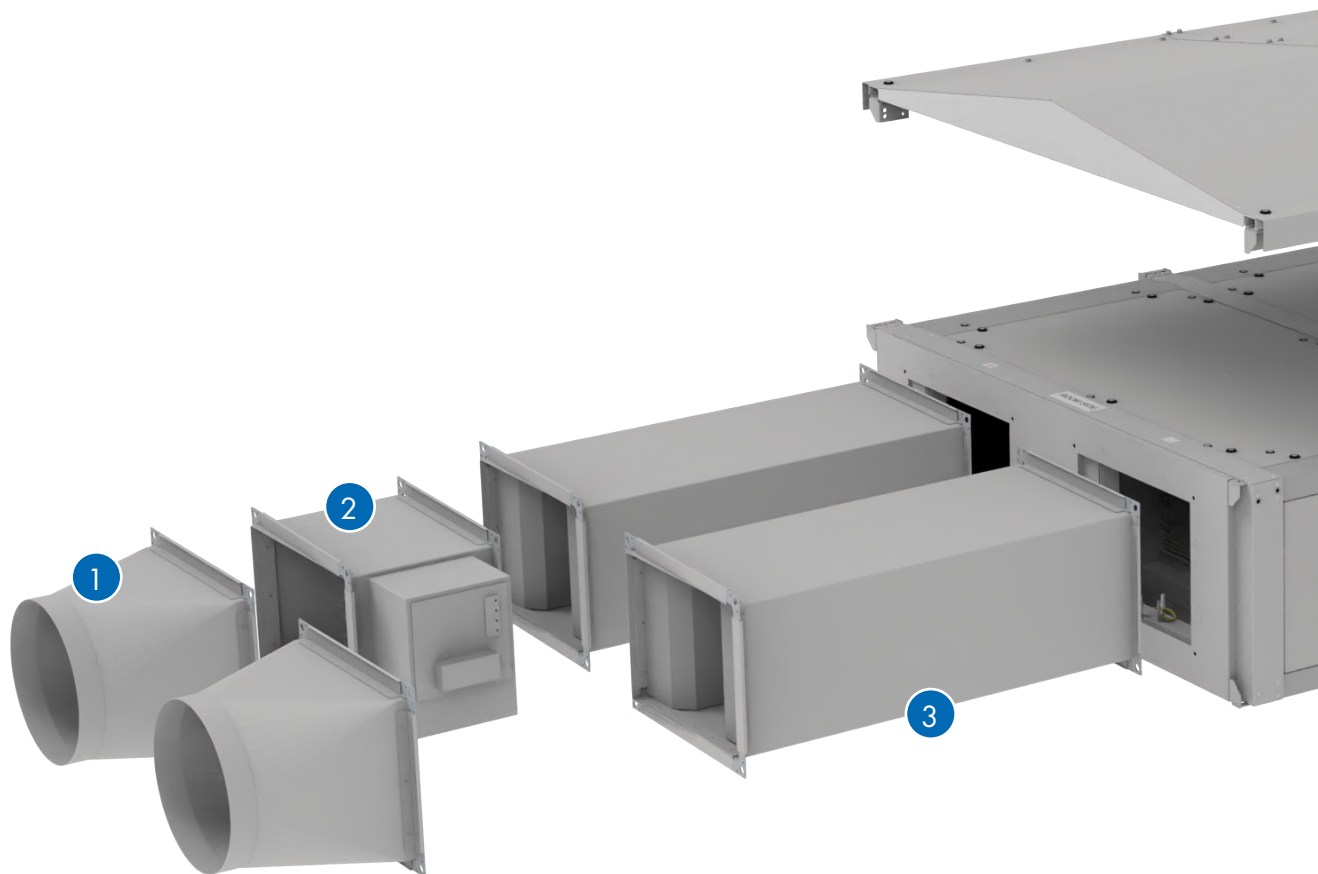

1 Rectangular to Round

Rectangular to round transformation piece to allow fitting to standard circular ducting.

2 Heater and Cooler Section

Rectangular Duct mounted heater battery with either electric heating complete with integral thyristor controls, or LPHW water heating. Each are designed to provide approximately 10°C temperature rise. Chilled water cooler also available with integral condensate tray. Note, waterside controls are not included.

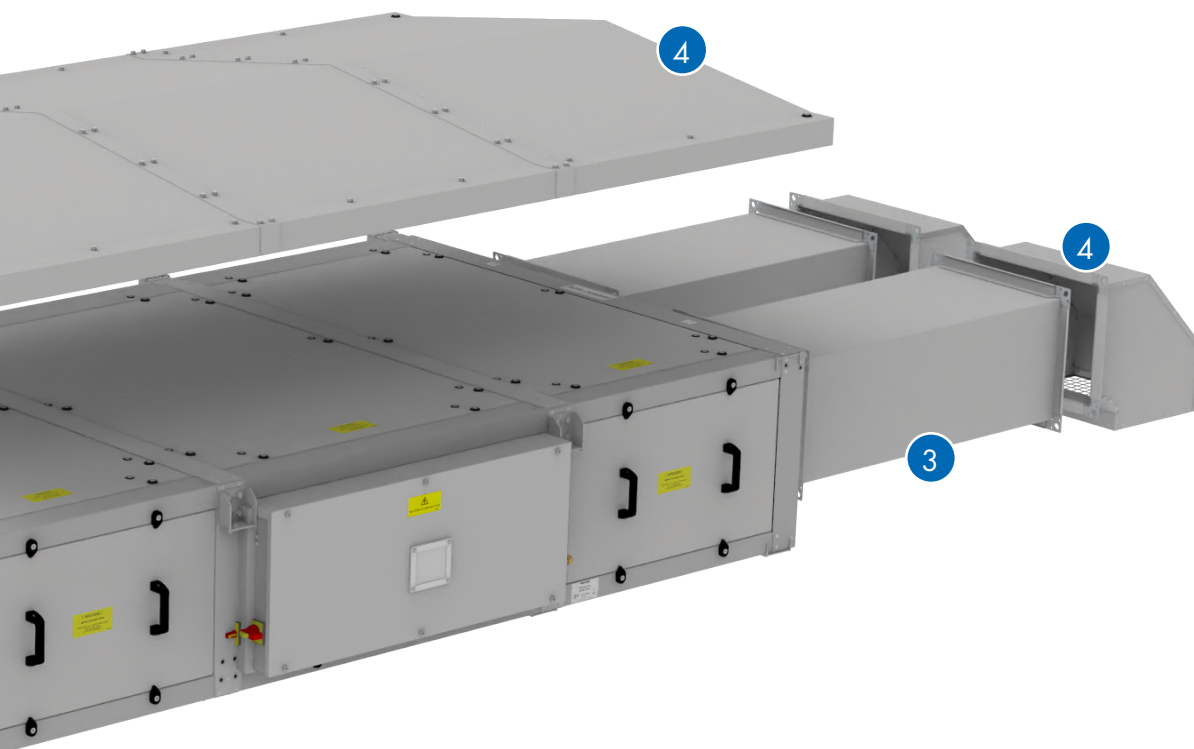

3 Duct Attenuators

Single-skinned attenuators purpose designed for the Sentinel Apex heat recovery range to minimise in duct noise. Attenuators are supplied in standard lengths of 900mm, 1200mm and 1500mm, constructed from Galvanised steel with profiled perforated sheet internal, mineral wool sound absorbing material and 30mm profiled flanges for duct and unit mounting.

4 Roof and Cowls

Optional weather roof and inlet/discharge cowls for external mounting. Pitched weather roof for externally mounted units, supplied in sections for fitting to the unit on site. Inlet/discharge cowl for external mounting minimising any ingress of water to the unit. Supplied loose from the unit and as individual items for fitting on site either to the unit or a duct section/attenuator.

Sentinel Apex HR06

- Very low sound levels independently tested and verified by SRL
- Low SFP utilising IE 5 equivalent motors
- High Heat Recovery Efficiency - up to 93% (EN308)
- Automatic summer bypass sized to eliminate performance loss
- ePM10 50% and ePM1 55% filters as standard (M5 / F7 equivalent)
- Filter access from bottom and side as standard
- Digital on board controller and remote room controller as standard
- App connectivity as standard
- Wired and Wireless communication sensors available
- Integral condensate tray and pump
- Electric frost protection heater as standard

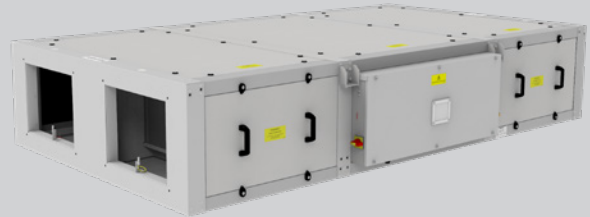

Performance simply delivered with more as standard

Vent-Axia's Sentinel Apex range of commercial heat recovery units with up to 93% EN308 heat recovery efficiency, low sound levels and low specific fan powers the range provides high levels of performance efficiently. A new advanced control system that provides on board control, in room control and App based control full functionality commissioning and monitoring is simply provided. This control can be coupled with Vent-Axia's new range of sensors with wired or wireless communication providing close control of, and monitoring of your indoor air quality. Sensors include CO₂, humidity and temperature and provide both proportional and switch control.

The Sentinel Apex HR06 unit is manufactured with a double skinned pentapost construction incorporating aluzinc frames and panels. The panels are acoustically and thermally treated with 90kg/m³ high efficiency acoustic and thermally insulating foam (fire retardant to BS476 Part 7 Class 1 & Part 6 Class O). The construction of the unit, IPX4, allows for internal and external mounting as standard, however, the roof assembly should be included for full external locations.

The housing is designed to be as compact as possible for concealed false ceiling applications with top and bottom access panels for maintenance. Access panels are sized to enable single person maintenance.

The fans utilised in the Sentinel Apex HR06 are the latest EC/DC external rotor motors specifically chosen for their low power consumption and low noise characteristics. The assembly is dynamically balanced to DIN ISO 1940 Grade 6.3. Ball bearings are greased for life. Insulation is Class 'B' (from -25°C to +60°C). All models incorporate internal electronic overload protection and a soft start function.

The Sentinel Apex HR06 is complete as standard with ISO ePM10 50% (M5) extract filter and ISO ePM1 55% (F7) supply, complete with a filter change warning. Filters have been selected to fully comply with the requirements of ISO16890 whilst having low pressure loss characteristics.

An integral electric frost heater is included to provide frost protection of the cell and filters down to -10°C. The integral controls also allow this heater to be utilised as a top up heater.

The unit is complete with an integral summer bypass facility which has

been designed to provide full bypass without impact to the airflow or power consumption of the unit whilst in bypass mode.

Airflow and power consumption tested in accordance with BS EN 5801. Sound data derived from independent testing at Sound Research Laboratories in accordance with EN ISO 3741:2010. Published dB(A) figures are free field sound pressure levels at 3m with spherical propagation at a reference level of 2 x 10⁻⁵ Pa. The inlet/outlet sound power level spectra figures are dB with a reference of 10⁻¹² watts.

An integral condensate tray is fitted along with an internal quiet running high quality pump allowing for removal of the condensate via a 10mm condensate pipe.

To facilitate normal access and maintenance to the unit there are both side and bottom access panels as standard. Should it be required, all panels are removable allowing access and removal of the heat recovery cell and all other components. A lockable isolator is fitted to the control panel preventing accidental operation whilst any maintenance is being carried out.

The electrical supply for the unit is 230V +/- 10% / 50/60Hz / 1ph. A 24V DC power is available from the unit for powering any of the matched sensors and switches.

The Sentinel Apex HR06 unit is fitted with an integrated control system as standard with a purpose designed user interface controller incorporating an alphanumerical 2 line display with 4 button keypad for fan status and a basic commissioning setup mounted within the control panel. A remote HMI is also included for that can be mounted within the room that is being ventilated. This allows for local monitoring of the unit along with the commissioning set-up.

App based control is also available via the Vent-Axia Connect App. This provides detailed commissioning and monitoring information and the ability to control the unit remotely.

A full range of sensors is available including humidity, temperature and CO₂ monitoring. These sensors are available for both wired and wireless communication with the wireless sensors being either local mains or battery powered.

Dimensions (mm)

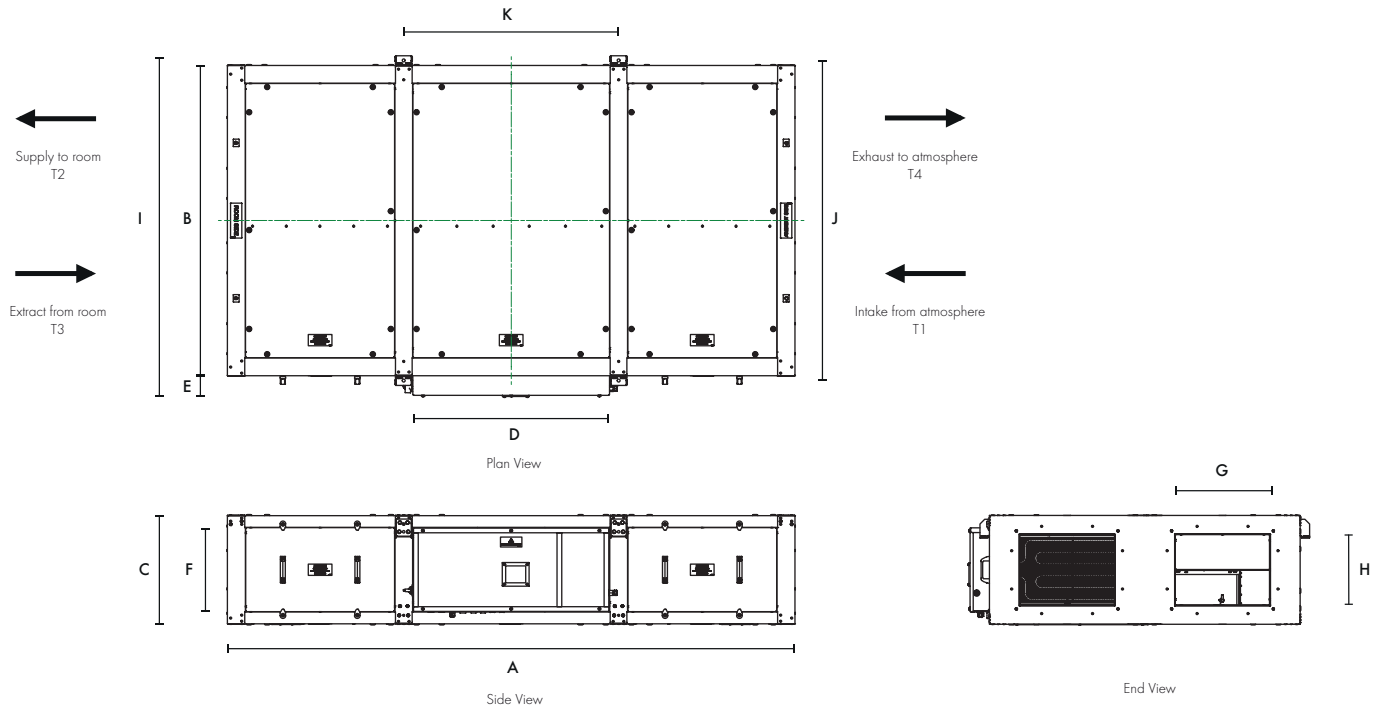

A (LENGTH)	B (WIDTH)	C (HEIGHT)	D	E	F	G	H	I	J	K	kg
2141	1323	350	719	89	248	400	200	1450	1363	791	275

Heat Recovery Efficiency

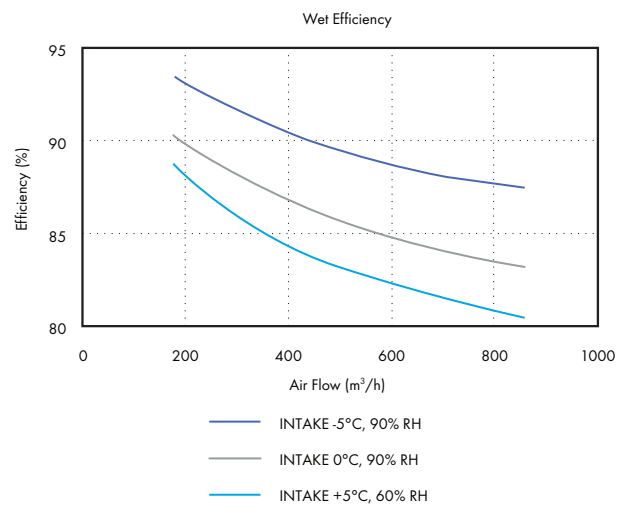
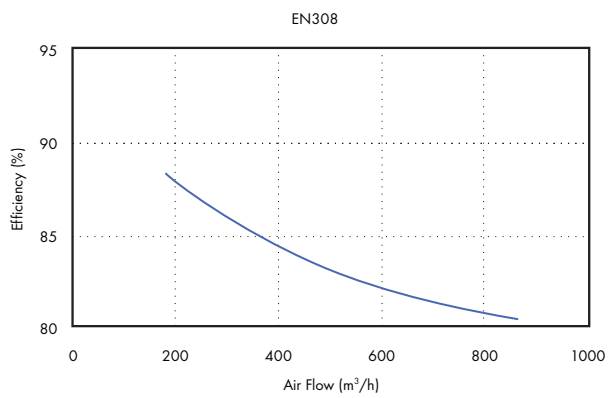

Performance Guide - Sentinel Apex HR06

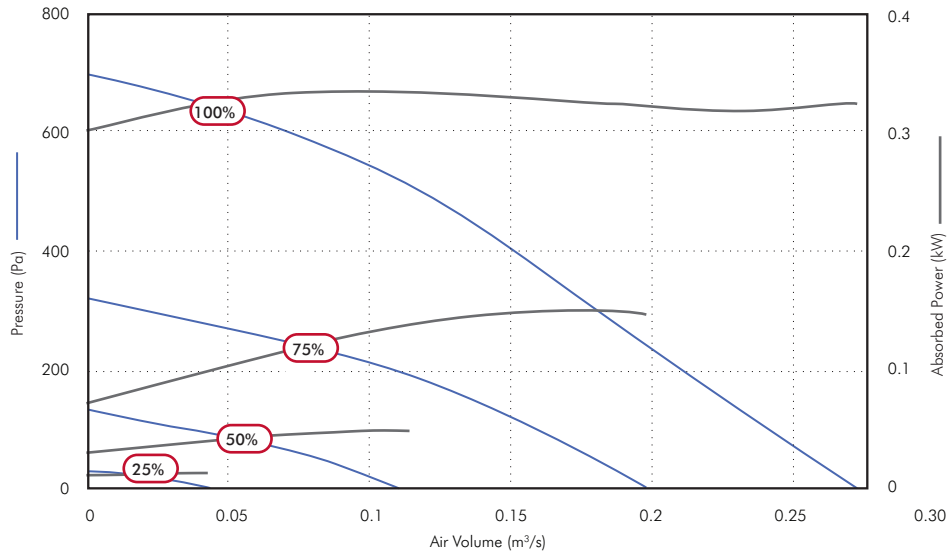

Speed	Airflow, m³/s @ Pa											Fans F.L.C.	Supply Voltage	Frost Heater	Unit Rated Current	
	0	25	50	100	150	200	250	300	400	500						
100%	m³/s	0.27	0.27	0.26	0.24	0.22	0.21	0.19	0.18	0.15	0.12	1.5A	230/1/50	2.4kW	12A	
	SFP	1.19	1.21	1.25	1.34	1.42	1.51	1.67	1.82	2.19	2.78					
	kW	0.323	0.320	0.320	0.318	0.318	0.320	0.323	0.334	0.334	0.334					
75%	m³/s	0.20	0.19	0.18	0.16	0.13	0.11	0.07								
	SFP	0.73	0.77	0.84	0.93	1.07	1.23	1.66								
	kW	0.144	0.145	0.147	0.147	0.143	0.132	0.116								
50%	m³/s	0.11	0.10	0.08	0.04											
	SFP	0.41	0.47	0.55	0.95											
	kW	0.045	0.045	0.044	0.036											
25%	m³/s	0.04	0.01													
	SFP	0.012	0.27													
	kW	0.011	1.06													

Sound Data - Sentinel Apex HR06

Speed	Test Mode	Sound Pressure level @ 3.0m dBA								
		63	125	250	500	1k	2k	4k	8k	
100%	Breakout	58	54	56	48	46	43	35	29	32
	Exhaust T4	58	55	61	54	54	54	46	36	
	Extract T3	64	64	72	64	56	56	55	48	
	Intake T1	64	64	71	63	57	56	55	48	
	Supply T2	58	54	59	53	53	54	46	36	
75%	Breakout	53	52	54	40	39	36	29	23	27
	Exhaust T4	52	50	52	47	46	47	39	28	
	Extract T3	60	59	68	54	48	48	47	40	
	Intake T1	59	59	67	55	50	49	47	39	
	Supply T2	52	50	54	46	47	48	39	28	
50%	Breakout	46	51	38	30	28	26	25	21	17
	Exhaust T4	45	55	41	36	35	35	26	23	
	Extract T3	53	64	53	44	37	36	34	26	
	Intake T1	54	68	53	44	39	37	34	26	
	Supply T2	45	49	41	35	35	36	26	24	
25%	Breakout	40	35	30	17	19	16	22	21	9
	Exhaust T4	38	32	27	21	19	17	18	23	
	Extract T3	44	43	35	28	20	18	19	23	
	Intake T1	44	40	35	27	21	18	18	23	
	Supply T2	37	32	27	21	19	18	19	24	

For full sound and performance data please use our Fan Selection Program www.vent-axia.com/fanselector/product/apex
 Sound data derived from independent testing at Sound Research Laboratories in accordance with EN ISO 3741:2010. Published dB(A) figures are free field sound pressure levels at 3m with spherical propagation at a reference level of 2×10^{-5} Pa. The inlet/outlet sound power level spectra figures are dB with a reference of 10^{-12} watts.

Accessories

Attenuator



Single skinned attenuators purpose designed for the Apex Heat Recovery range to minimise in duct noise. Attenuators are supplied in standard lengths of 900mm, 1200mm and 1500mm, constructed from Galvanised steel with profiled perforated sheet internal, mineral wool sound absorbing material and 30mm profiled flanges for duct and unit mounting. Data has been obtained by testing in accordance with BS EN ISO7235:2009.

Stock Ref.	Dimensions (mm)			kg	Insertion Loss dB								m ³ /hr @ Pa		
	Length	Width	Height		63	125	250	500	1k	2k	4k	8k	300	600	1000
ATT900-HR06	900	400	200	17	2	5	11	19	33	39	31	24	8	30	83
ATT1200-HR06	1200	400	200	21	3	6	14	26	43	45	35	27	8	33	92
ATT1500-HR06	1500	400	200	31	4	7	18	32	52	52	38	30	9	37	103

Duct mounted Heating / Cooling



Rectangular duct mounted heater battery with either electric heating complete with integral thyristor controls, or LPHW water heating, each designed to provide approximately 10°C temperature rise. Chilled water cooler also available with integral condensate tray. Note waterside controls are not included.

Stock Ref.	Type	Dimensions (mm)			kg	Heater rating kW	Electrical supply	Water Temp			m ³ /hr @ Pa		
		Length	Width	Height				Flow	Return	Connection	300	600	1000
EHB-HR06	HR 6 Duct mounted Rectangular electric heater with controls	300	400	200	5	2.00	230/1/50	N/A	N/A	N/A	8	33	92
HWB-HR06	HR 6 Duct mounted Rectangular LPHW heating battery	200	400	200	5	2.01	N/A	80°C	60°C	1/2"	8	33	92
CWB-HR06	HR 6 Duct mounted Rectangular water cooling battery	200	400	200	5	2.52	N/A	6°C	12°C	3/4"	8	33	92

Roof Assembly

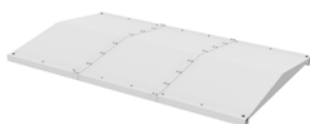

Pitched roof for external mounting, supplied separate for fitting on site.

Stock Ref	Length mm	Width mm	Height mm	Weight kg
WRF-HR06	2141	1455	95	48

Intake / Exhaust Cowl



Weather inlet/discharge cowl for external mounting (one required for each airstream).

Stock Ref	Length mm	Width mm	Height mm	Weight kg
497196	294	402	274	4

Transformation Piece



Rectangular to round transformation piece designed to fix directly to the unit or any of the specific HR06 duct accessories to enable connection to 250mm round ducting.

Stock Ref	Length mm	Width mm	Height mm	Weight kg
497222	250	400	200	3

Flexible Connection



Stock Ref	Length mm	Width mm	Height mm	Weight kg
497018	130	400	200	3

Sentinel Apex HR10

- Very low sound levels independently tested and verified by SRL
- Low SFP utilising IE 5 equivalent motors
- High Heat Recovery Efficiency - up to 93% (EN308)
- Automatic summer bypass sized to eliminate performance loss
- ePM10 50% and ePM1 55% filters as standard (M5 / F7 equivalent)
- Filter access from bottom and side as standard
- Digital on board controller and remote room controller as standard
- App connectivity as standard
- Wired and Wireless communication sensors available
- Integral condensate tray and pump
- Electric frost protection heater as standard

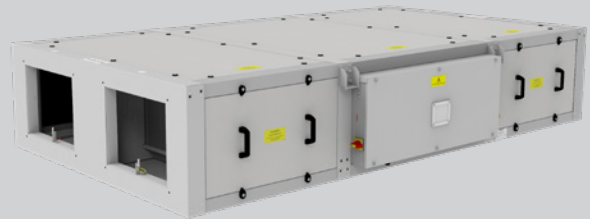

Performance simply delivered with more as standard

Vent-Axia's Sentinel Apex range of commercial heat recovery units with up to 93% EN308 heat recovery efficiency, low sound levels and low specific fan powers the range provides high levels of performance efficiently. A new advanced control system that provides on board control, in room control and App based control full functionality commissioning and monitoring is simply provided. This control can be coupled with Vent-Axia's new range of sensors with wired or wireless communication providing close control of, and monitoring of your indoor air quality. Sensors include CO₂, humidity and temperature and provide both proportional and switch control.

The Sentinel Apex HR10 unit is manufactured with a double skinned pentapost construction incorporating aluzinc frames and panels. The panels are acoustically and thermally treated with 90kg/m³ high efficiency acoustic and thermally insulating foam (fire retardant to BS476 Part 7 Class 1 & Part 6 Class O). The construction of the unit, IPX4, allows for internal and external mounting as standard, however, the roof assembly should be included for full external locations.

The housing is designed to be as compact as possible for concealed false ceiling applications with top and bottom access panels for maintenance. Access panels are sized to enable single person maintenance.

The fans utilised in the Sentinel Apex HR10 are the latest EC/DC external rotor motors specifically chosen for their low power consumption and low noise characteristics. The assembly is dynamically balanced to DIN ISO 1940 Grade 6.3. Ball bearings are greased for life. Insulation is Class 'B' (from -25°C to +60°C). All models incorporate internal electronic overload protection and a soft start function.

The Sentinel Apex HR10 is complete as standard with ISO ePM10 50% (M5) extract filter and ISO ePM1 55% (F7) supply, complete with a filter change warning. Filters have been selected to fully comply with the requirements of ISO16890 whilst having low pressure loss characteristics.

An integral electric frost heater is included to provide frost protection of the cell and filters down to -10°C. The integral controls also allow this heater to be utilised as a top up heater.

The unit is complete with an integral summer bypass facility which has

been designed to provide full bypass without impact to the airflow or power consumption of the unit whilst in bypass mode.

Airflow and power consumption tested in accordance with BS EN 5801. Sound data derived from independent testing at Sound Research Laboratories in accordance with EN ISO 3741:2010. Published dB(A) figures are free field sound pressure levels at 3m with spherical propagation at a reference level of 2 x 10⁻⁵ Pa. The inlet/outlet sound power level spectra figures are dB with a reference of 10⁻¹² watts.

An integral condensate tray is fitted along with an internal quiet running high quality pump allowing for removal of the condensate via a 10mm condensate pipe.

To facilitate normal access and maintenance to the unit there are both side and bottom access panels as standard. Should it be required, all panels are removable allowing access and removal of the heat recovery cell and all other components. A lockable isolator is fitted to the control panel preventing accidental operation whilst any maintenance is being carried out.

The electrical supply for the unit is 230V +/- 10% / 50/60Hz / 1ph. A 24V DC power is available from the unit for powering any of the matched sensors and switches.

The Sentinel Apex HR10 unit is fitted with an integrated control system as standard with a purpose designed user interface controller incorporating an alphanumerical 2 line display with 4 button keypad for fan status and a basic commissioning setup mounted within the control panel. A remote HMI is also included for that can be mounted within the room that is being ventilated. This allows for local monitoring of the unit along with the commissioning set-up.

App based control is also available via the Vent-Axia Connect App. This provides detailed commissioning and monitoring information and the ability to control the unit remotely.

A full range of sensors is available including humidity, temperature and CO₂ monitoring. These sensors are available for both wired and wireless communication with the wireless sensors being either local mains or battery powered.

Dimensions (mm)

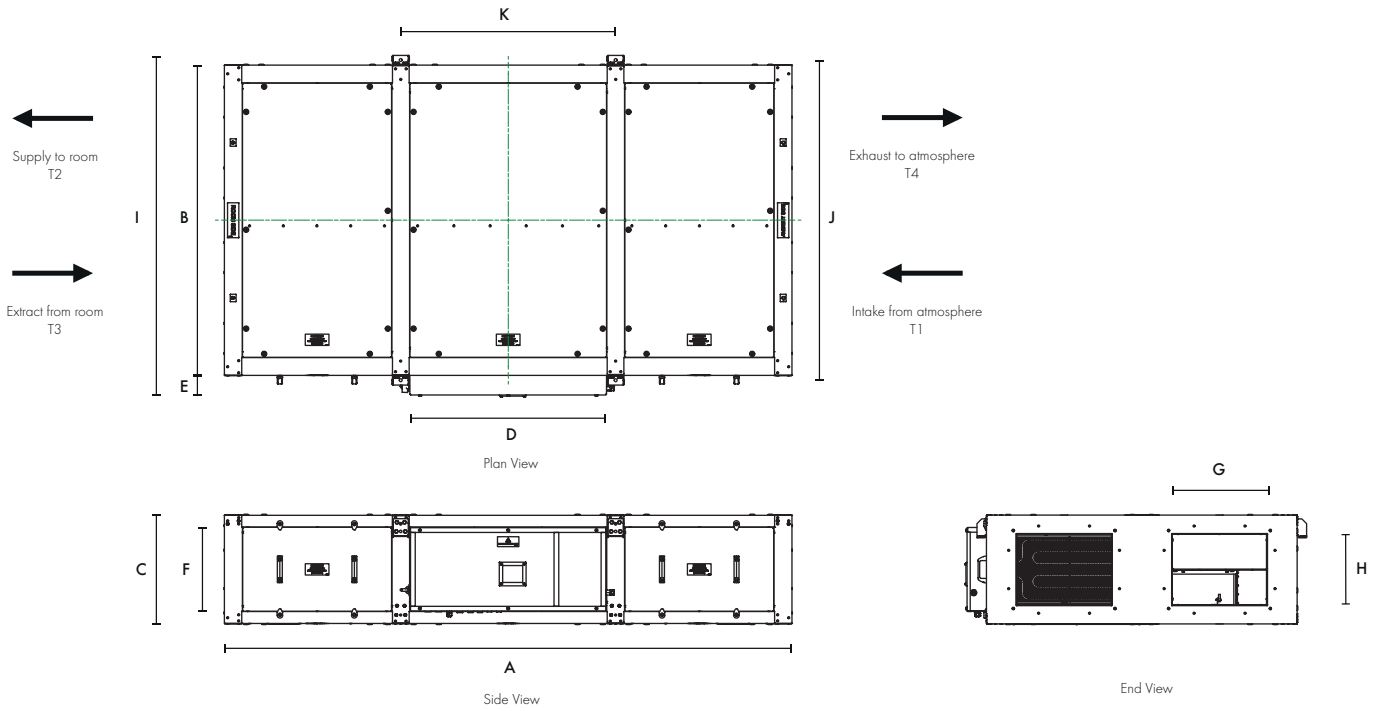

A (LENGTH)	B (WIDTH)	C (HEIGHT)	D	E	F	G	H	I	J	K	kg
2400	1312	460	831	88	356	400	300	1440	1353	908	388

Heat Recovery Efficiency

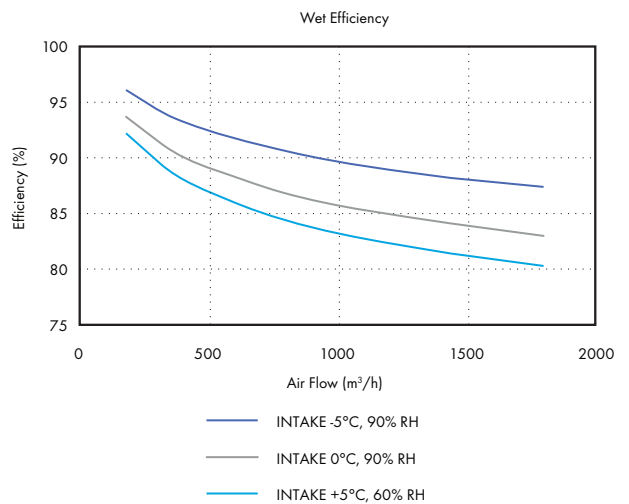
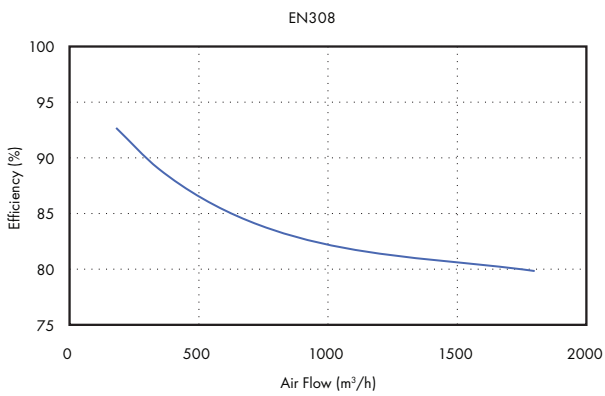

Performance Guide - Sentinel Apex HR10

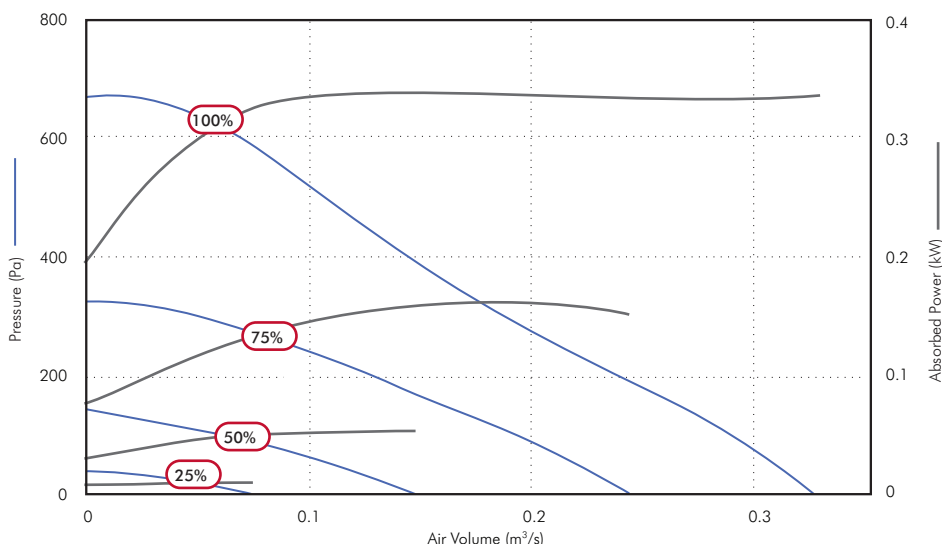

Speed	Airflow, m³/s @ Pa											Fans F.L.C.	Supply Voltage	Frost Heater	Unit Rated Current
	0	25	50	100	150	200	250	300	400	500					
100%	m³/s	0.33	0.32	0.31	0.29	0.26	0.24	0.21	0.18	0.15	0.10	1.5A	230/1/50	2.8kW	14A
	SFP	1.03	1.05	1.08	1.17	1.28	1.40	1.61	1.87	2.32	3.24				
	kW	0.337	0.337	0.337	0.334	0.333	0.333	0.335	0.337	0.337	0.338				
75%	m³/s	0.24	0.23	0.22	0.19	0.15	0.13	0.09							
	SFP	0.62	0.67	0.74	0.84	1.03	1.22	1.55							
	kW	0.151	0.155	0.160	0.160	0.160	0.153	0.138							
50%	m³/s	0.15	0.13	0.11	0.06										
	SFP	0.34	0.37	0.47	0.79										
	kW	0.050	0.050	0.051	0.046										
25%	m³/s	0.07	0.03												
	SFP	0.08	0.21												
	kW	0.006	0.006												

Sound Data - Sentinel Apex HR10

Speed	Test Mode	63	125	250	500	1k	2k	4k	8k	Sound Pressure level @ 3.0m dBA
100%	Breakout	57	53	55	47	42	40	36	26	30
	Exhaust T4	55	57	63	54	56	52	42	33	
	Extract T3	58	59	71	61	59	59	56	51	
	Intake T1	58	58	68	58	60	59	56	51	
	Supply T2	51	49	61	54	54	51	42	34	
75%	Breakout	51	48	48	44	35	33	25	21	24
	Exhaust T4	50	53	54	51	48	45	33	25	
	Extract T3	53	56	52	56	54	51	48	41	
	Intake T1	53	56	61	51	54	51	47	39	
	Supply T2	46	46	53	48	46	44	33	25	
50%	Breakout	45	44	35	33	24	23	18	21	14
	Exhaust T4	44	49	39	38	38	35	22	23	
	Extract T3	48	54	50	44	42	41	36	25	
	Intake T1	47	52	51	42	42	40	34	25	
	Supply T2	40	43	38	37	37	34	22	23	
25%	Breakout	36	31	27	18	14	15	17	21	6
	Exhaust T4	36	30	24	20	19	17	18	23	
	Extract T3	40	37	34	26	23	19	19	22	
	Intake T1	40	34	32	23	20	17	19	23	
	Supply T2	31	27	24	20	17	15	18	23	

For full sound and performance data please use our Fan Selection Program www.vent-axia.com/fanselector/product/apex
 Sound data derived from independent testing at Sound Research Laboratories in accordance with EN ISO 3741:2010. Published dB(A) figures are free field sound pressure levels at 3m with spherical propagation at a reference level of 2×10^{-5} Pa. The inlet/outlet sound power level spectra figures are dB with a reference of 10^{-12} watts.

Accessories

Attenuator



Single skinned attenuators purpose designed for the Apex Heat Recovery range to minimise in duct noise. Attenuators are supplied in standard lengths of 900mm, 1200mm and 1500mm, constructed from Galvanised steel with profiled perforated sheet internal, mineral wool sound absorbing material and 30mm profiled flanges for duct and unit mounting. Data has been obtained by testing in accordance with BS EN ISO7235:2009.

Stock Ref.	Dimensions (mm)			kg	Insertion Loss dB								m ³ /hr @ Pa				
	Length	Width	Height		63	125	250	500	1k	2k	4k	8k	300	600	1000	1500	2000
ATT900-HR10	900	400	300	18	2	3	8	15	27	21	14	10	1	3	8	17	30
ATT1200-HR10	1200	400	300	23	2	4	10	19	36	24	16	12	1	3	8	18	32
ATT1500-HR10	1500	400	300	34	2	5	12	24	44	28	19	14	1	3	9	20	36

Duct mounted Heating / Cooling



Rectangular duct mounted heater battery with either electric heating complete with integral thyristor controls, or LPHW water heating, each designed to provide approximately 10°C temperature rise. Chilled water cooler also available with integral condensate tray. Note waterside controls are not included.

Stock Ref.	Type	Dimensions (mm)			kg	Heater rating kW	Electrical supply	Water Temp			m ³ /hr @ Pa				
		Length	Width	Height				Flow	Return	Connection	300	600	1000	1500	2000
EHB-HR10	HR 10 Duct mounted Rectangular electric heater with controls	300	400	300	6	4.00	230/1/50	N/A	N/A	N/A	1	3	8	18	32
HWB-HR10	HR 10 Duct mounted Rectangular LPHW heating battery	200	400	300	7	3.35	N/A	80°C	60°C	1/2"	1	3	8	18	32
CWB-HR10	HR 10 Duct mounted Rectangular water cooling battery	200	500	300	7	4.13	N/A	6°C	12°C	3/4"	1	3	8	18	32

Roof Assembly

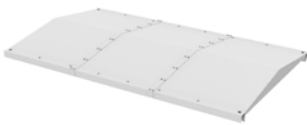

Stock Ref	Length mm	Width mm	Height mm	Weight kg
WRF-HR10	2400	1455	95	52

Intake / Exhaust Cowl



Weather inlet/discharge cowl for external mounting (one required for each airstream).

Stock Ref	Length mm	Width mm	Height mm	Weight kg
497200	394	402	380	6

Transformation Piece



Rectangular to round transformation piece designed to fix directly to the unit or any of the specific HR10 duct accessories to enable connection to 315mm round ducting.

Stock Ref	Length mm	Width mm	Height mm	Weight kg
497223	325	400	300	4

Flexible Connection

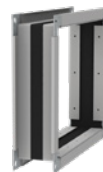

Stock Ref	Length mm	Width mm	Height mm	Weight kg
497019	130	400	300	4

Sentinel Apex HR15

- Very low sound levels independently tested and verified by SRL
- Low SFP utilising IE 5 equivalent motors
- High Heat Recovery Efficiency – up to 93% (EN308)
- Automatic summer bypass sized to eliminate performance loss
- ePM10 50% and ePM1 55% filters as standard (M5 / F7 equivalent)
- Filter access from bottom and side as standard
- Digital on board controller and remote room controller as standard
- App connectivity as standard
- Wired and Wireless communication sensors available
- Integral condensate tray and pump
- Electric frost protection heater as standard

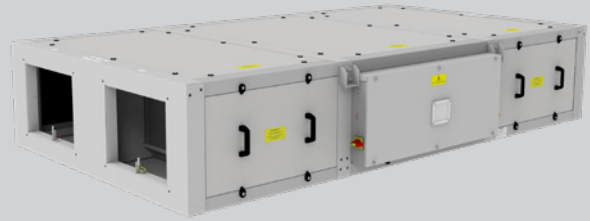

Performance simply delivered with more as standard

Vent-Axia's Sentinel Apex range of commercial heat recovery units with up to 93% EN308 heat recovery efficiency, low sound levels and low specific fan powers the range provides high levels of performance efficiently. A new advanced control system that provides on board control, in room control and App based control full functionality commissioning and monitoring is simply provided. This control can be coupled with Vent-Axia's new range of sensors with wired or wireless communication providing close control of, and monitoring of your indoor air quality. Sensors include CO₂, humidity and temperature and provide both proportional and switch control.

The Sentinel Apex HR15 unit is manufactured with a double skinned pentapost construction incorporating aluzinc frames and panels. The panels are acoustically and thermally treated with 90kg/m³ high efficiency acoustic and thermally insulating foam (fire retardant to BS476 Part 7 Class 1 & Part 6 Class O). The construction of the unit, IPX4, allows for internal and external mounting as standard, however, the roof assembly should be included for full external locations.

The housing is designed to be as compact as possible for concealed false ceiling applications with top and bottom access panels for maintenance. Access panels are sized to enable single person maintenance.

The fans utilised in the Sentinel Apex HR15 are the latest EC/DC external rotor motors specifically chosen for their low power consumption and low noise characteristics. The assembly is dynamically balanced to DIN ISO 1940 Grade 6.3. Ball bearings are greased for life. Insulation is Class 'B' (from -25°C to +60°C). All models incorporate internal electronic overload protection and a soft start function.

The Sentinel Apex HR15 is complete as standard with ISO ePM10 50% (M5) extract filter and ISO ePM1 55% (F7) supply, complete with a filter change warning. Filters have been selected to fully comply with the requirements of ISO16890 whilst having low pressure loss characteristics.

An integral electric frost heater is included to provide frost protection of the cell and filters down to -10°C. The integral controls also allow this heater to be utilised as a top up heater.

The unit is complete with an integral summer bypass facility which has

been designed to provide full bypass without impact to the airflow or power consumption of the unit whilst in bypass mode.

Airflow and power consumption tested in accordance with BS EN 5801. Sound data derived from independent testing at Sound Research Laboratories in accordance with EN ISO 3741:2010. Published dB(A) figures are free field sound pressure levels at 3m with spherical propagation at a reference level of 2×10^{-5} Pa. The inlet/outlet sound power level spectra figures are dB with a reference of 10^{-12} watts.

An integral condensate tray is fitted along with an internal quiet running high quality pump allowing for removal of the condensate via a 10mm condensate pipe.

To facilitate normal access and maintenance to the unit there are both side and bottom access panels as standard. Should it be required, all panels are removable allowing access and removal of the heat recovery cell and all other components. A lockable isolator is fitted to the control panel preventing accidental operation whilst any maintenance is being carried out.

The electrical supply for the unit is 230V +/- 10% / 50/60Hz / 1ph. A 24V DC power is available from the unit for powering any of the matched sensors and switches.

The Sentinel Apex HR15 unit is fitted with an integrated control system as standard with a purpose designed user interface controller incorporating an alphanumeric 2 line display with 4 button keypad for fan status and a basic commissioning setup mounted within the control panel. A remote HMI is also included for that can be mounted within the room that is being ventilated. This allows for local monitoring of the unit along with the commissioning set-up.

App based control is also available via the Vent-Axia Connect App. This provides detailed commissioning and monitoring information and the ability to control the unit remotely.

A full range of sensors is available including humidity, temperature and CO₂ monitoring. These sensors are available for both wired and wireless communication with the wireless sensors being either local mains or battery powered.

Dimensions (mm)

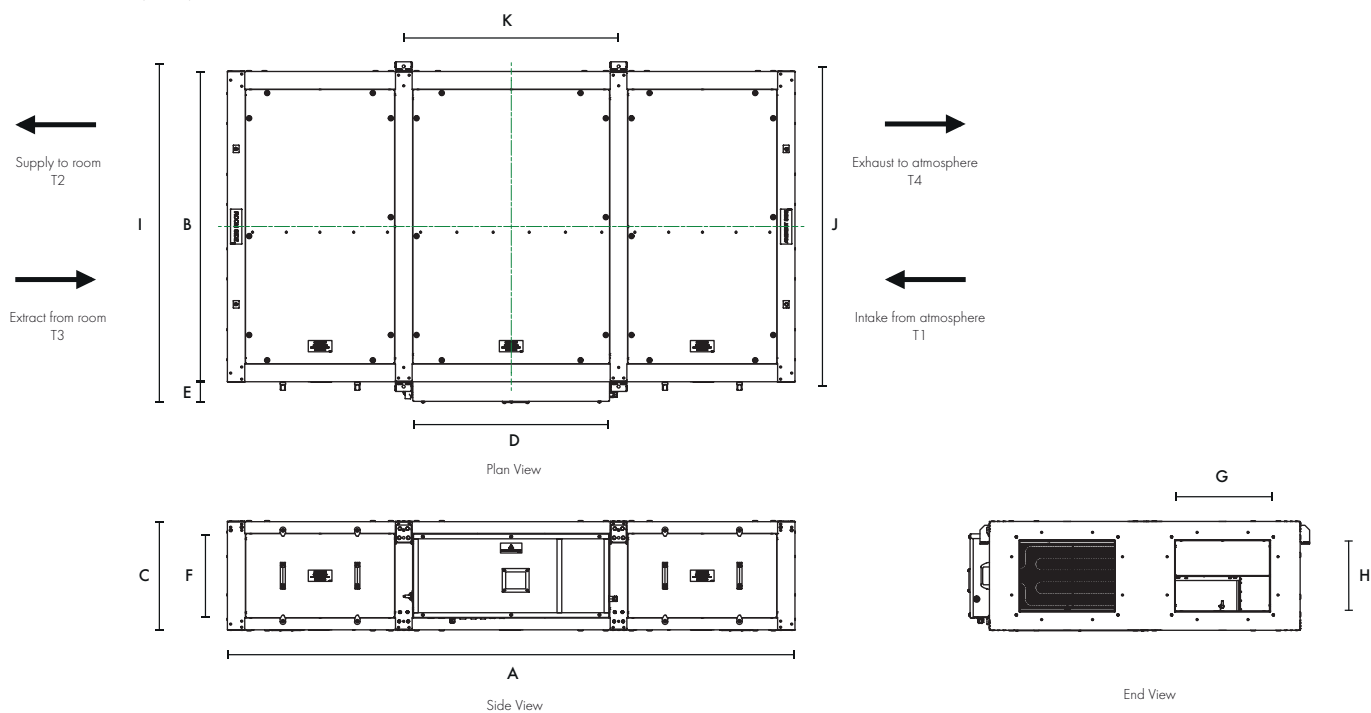

A (LENGTH)	B (WIDTH)	C (HEIGHT)	D	E	F	G	H	I	J	K	kg
2400	1312	460	831	88	356	400	300	1440	1353	908	348

Heat Recovery Efficiency

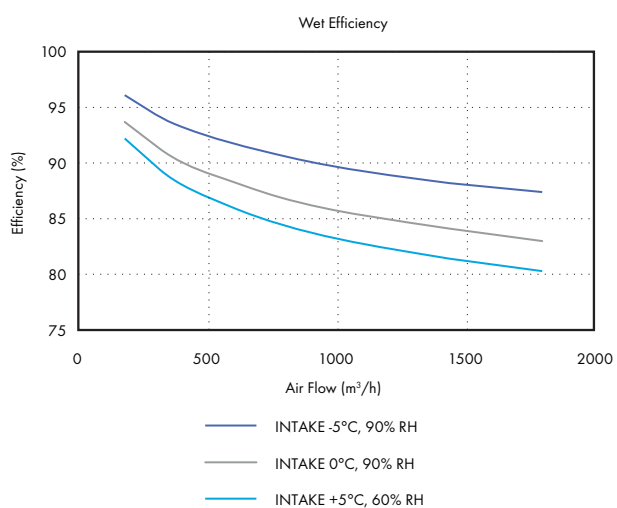
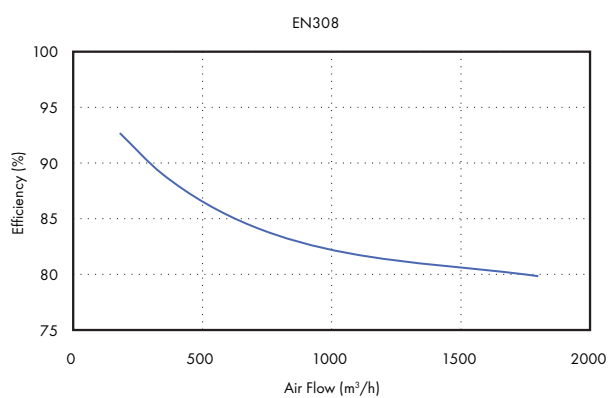

Performance Guide - Sentinel Apex HR15

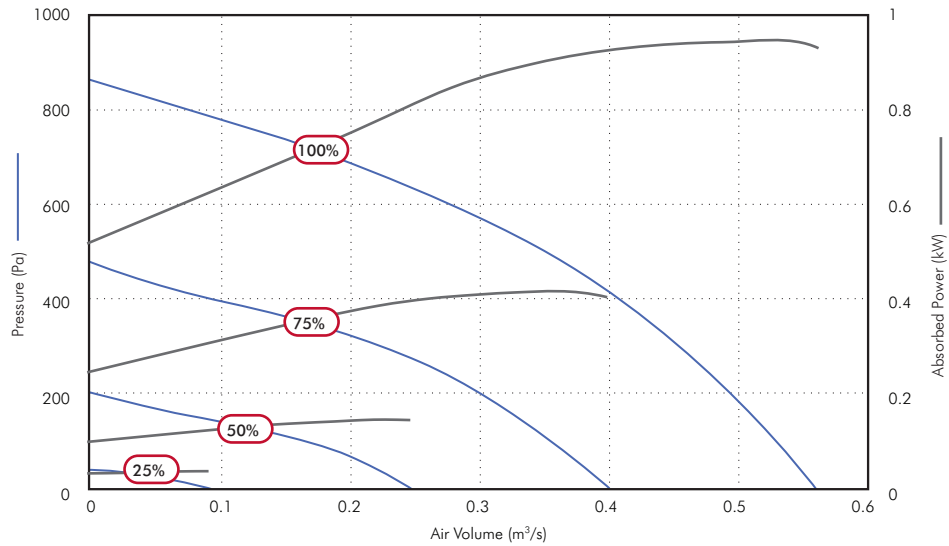

Speed	Airflow, m³/s @ Pa									Fans F.L.C.	Supply Voltage	Frost Heater	Unit Rated Current
	0	25	50	100	150	200	300	400					
100%	m³/s	0.56	0.55	0.54	0.52	0.50	0.49	0.45	0.40	5.0A	230/1/50	5.6kW	29.0A
	SFP	1.49	1.53	1.56	1.59	1.67	1.71	1.85	2.06				
	kW	0.83	0.85	0.85	0.84	0.84	0.84	0.84	0.83				
75%	m³/s	0.40	0.39	0.38	0.35	0.33	0.30	0.22	0.09				
	SFP	0.91	0.96	0.97	1.06	1.13	1.23	1.55	2.93				
	kW	0.36	0.38	0.37	0.37	0.37	0.36	0.34	0.27				
50%	m³/s	0.25	0.23	0.21	0.16	0.09							
	SFP	0.51	0.56	0.60	0.76	1.20							
	kW	0.13	0.13	0.13	0.12	0.11							
25%	m³/s	0.09	0.04										
	SFP	0.32	0.63										
	kW	0.03	0.03										

Sound Data - Sentinel Apex HR15

Speed	Test Mode	Sound Pressure level @ 3.0m dBA								
		63	125	250	500	1k	2k	4k	8k	
100%	Breakout	65	59	67	59	51	48	41	40	38
	Exhaust T4	63	60	46	64	62	57	46	36	
	Extract T3	69	67	80	72	64	61	57	57	
	Intake T1	70	67	79	69	65	62	57	53	
	Supply T2	63	59	74	65	62	57	46	40	
75%	Breakout	59	57	62	52	43	38	32	32	30
	Exhaust T4	57	57	65	57	53	47	36	29	
	Extract T3	64	64	72	65	56	53	48	50	
	Intake T1	63	65	74	62	56	52	47	47	
	Supply T2	56	56	67	57	53	58	36	33	
50%	Breakout	53	57	46	40	32	27	23	24	22
	Exhaust T4	50	53	48	43	41	35	24	24	
	Extract T3	55	61	60	53	45	40	40	34	
	Intake T1	56	62	60	51	45	40	38	28	
	Supply T2	49	52	50	43	41	35	25	24	
25%	Breakout	49	51	40	31	27	23	20	24	14
	Exhaust T4	49	38	34	25	24	22	17	24	
	Extract T3	52	42	42	31	26	26	18	24	
	Intake T1	51	42	41	30	27	23	18	23	
	Supply T2	47	36	33	25	24	21	16	23	

For full sound and performance data please use our Fan Selection Program www.vent-axia.com/fanselector/product/apex
 Sound data derived from independent testing at Sound Research Laboratories in accordance with EN ISO 3741:2010. Published dB(A) figures are free field sound pressure levels at 3m with spherical propagation at a reference level of 2×10^{-5} Pa. The inlet/outlet sound power level spectra figures are dB with a reference of 10^{-12} watts.

Accessories

Attenuator



Single skinned attenuators purpose designed for the Apex Heat Recovery range to minimise in duct noise. Attenuators are supplied in standard lengths of 900mm, 1200mm and 1500mm, constructed from Galvanised steel with profiled perforated sheet internal, mineral wool sound absorbing material and 30mm profiled flanges for duct and unit mounting. Data has been obtained by testing in accordance with BS EN ISO7235:2009.

Stock Ref.	Dimensions (mm)			kg	Insertion Loss dB								m ³ /hr @ Pa				
	Length	Width	Height		63	125	250	500	1k	2k	4k	8k	300	600	1000	1500	2000
ATT900-HR15	900	400	300	18	2	3	8	15	27	21	14	10	1	3	8	17	30
ATT1200-HR15	1200	400	300	23	2	4	10	19	36	24	16	12	1	3	8	18	32
ATT1500-HR15	1500	400	300	34	2	5	12	24	44	28	19	14	1	3	9	20	36

Duct mounted Heating / Cooling



Rectangular duct mounted heater battery with either electric heating complete with integral thyristor controls, or LPHW water heating, each designed to provide approximately 10°C temperature rise. Chilled water cooler also available with integral condensate tray. Note waterside controls are not included.

Stock Ref.	Type	Dimensions (mm)			kg	Heater rating kW	Electrical supply	Water Temp			m ³ /hr @ Pa				
		Length	Width	Height				Flow	Return	Connection	300	600	1000	1500	2k
EHB-HR15	Heater with controls	300	400	300	7	5.00	230/1/50	N/A	N/A	N/A	1	3	8	18	32
HWB-HR15	HR 15 Duct mounted Rectangular LPHW heating battery	200	400	310	8	5.03	N/A	80°C	60°C	1/2"	1	3	8	18	32
CWB-HR15	HR 15 Duct mounted Rectangular water cooling battery	200	500	350	8	6.23	N/A	6°C	12°C	3/4"	1	3	8	18	32

Roof Assembly

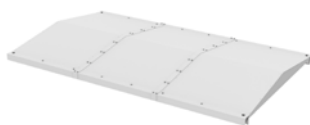

Stock Ref	Length mm	Width mm	Height mm	Weight kg
WRF-HR15	2400	1455	95	52

Intake / Exhaust Cowl



Weather inlet/discharge cowl for external mounting (one required for each airstream).

Stock Ref	Length mm	Width mm	Height mm	Weight kg
499140	394	402	380	6

Transformation Piece



Rectangular to round transformation piece designed to fix directly to the unit or any of the specific HR15 duct accessories to enable connection to 315mm round ducting.

Stock Ref	Length mm	Width mm	Height mm	Weight kg
495296	325	400	300	4

Flexible Connection



Stock Ref	Length mm	Width mm	Height mm	Weight kg
497020	130	400	300	4

Sentinel Apex HR21

- Very low sound levels independently tested and verified by SRL
- Low SFP utilising IE 5 equivalent motors
- High Heat Recovery Efficiency – up to 93% (EN308)
- Automatic summer bypass sized to eliminate performance loss
- ePM10 50% and ePM1 55% filters as standard (M5 / F7 equivalent)
- Filter access from bottom and side as standard
- Digital on board controller and remote room controller as standard
- App connectivity as standard
- Wired and Wireless communication sensors available
- Integral condensate tray and pump
- Electric frost protection heater as standard

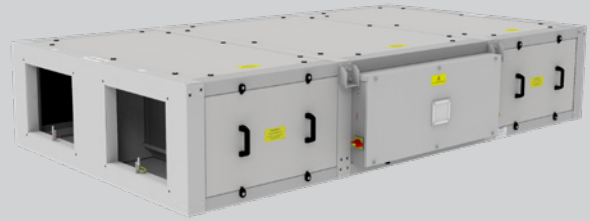

Performance simply delivered with more as standard

Vent-Axia's Sentinel Apex range of commercial heat recovery units with up to 93% EN308 heat recovery efficiency, low sound levels and low specific fan powers the range provides high levels of performance efficiently. A new advanced control system that provides on board control, in room control and App based control full functionality commissioning and monitoring is simply provided. This control can be coupled with Vent-Axia's new range of sensors with wired or wireless communication providing close control of, and monitoring of your indoor air quality. Sensors include CO₂, humidity and temperature and provide both proportional and switch control.

The Sentinel Apex HR21 unit is manufactured with a double skinned pentapost construction incorporating aluzinc frames and panels. The panels are acoustically and thermally treated with 90kg/m³ high efficiency acoustic and thermally insulating foam (fire retardant to BS476 Part 7 Class 1 & Part 6 Class O). The construction of the unit, IPX4, allows for internal and external mounting as standard, however, the roof assembly should be included for full external locations.

The housing is designed to be as compact as possible for concealed false ceiling applications with top and bottom access panels for maintenance. Access panels are sized to enable single person maintenance.

The fans utilised in the Sentinel Apex HR21 are the latest EC/DC external rotor motors specifically chosen for their low power consumption and low noise characteristics. The assembly is dynamically balanced to DIN ISO 1940 Grade 6.3. Ball bearings are greased for life. Insulation is Class 'B' (from -25°C to +60°C). All models incorporate internal electronic overload protection and a soft start function.

The Sentinel Apex HR21 is complete as standard with ISO ePM10 50% (M5) extract filter and ISO ePM1 55% (F7) supply, complete with a filter change warning. Filters have been selected to fully comply with the requirements of ISO16890 whilst having low pressure loss characteristics.

An integral electric frost heater is included to provide frost protection of the cell and filters down to -10°C. The integral controls also allow this heater to be utilised as a top up heater.

The unit is complete with an integral summer bypass facility which has

been designed to provide full bypass without impact to the airflow or power consumption of the unit whilst in bypass mode.

Airflow and power consumption tested in accordance with BS EN 5801. Sound data derived from independent testing at Sound Research Laboratories in accordance with EN ISO 3741:2010. Published dB(A) figures are free field sound pressure levels at 3m with spherical propagation at a reference level of 2×10^{-5} Pa. The inlet/outlet sound power level spectra figures are dB with a reference of 10^{-12} watts.

An integral condensate tray is fitted along with an internal quiet running high quality pump allowing for removal of the condensate via a 10mm condensate pipe.

To facilitate normal access and maintenance to the unit there are both side and bottom access panels as standard. Should it be required, all panels are removable allowing access and removal of the heat recovery cell and all other components. A lockable isolator is fitted to the control panel preventing accidental operation whilst any maintenance is being carried out.

The electrical supply for the unit is 230V +/- 10% / 50/60Hz / 1ph. A 24V DC power is available from the unit for powering any of the matched sensors and switches.

The Sentinel Apex HR21 unit is fitted with an integrated control system as standard with a purpose designed user interface controller incorporating an alphanumeric 2 line display with 4 button keypad for fan status and a basic commissioning setup mounted within the control panel. A remote HMI is also included for that can be mounted within the room that is being ventilated. This allows for local monitoring of the unit along with the commissioning set-up.

App based control is also available via the Vent-Axia Connect App. This provides detailed commissioning and monitoring information and the ability to control the unit remotely.

A full range of sensors is available including humidity, temperature and CO₂ monitoring. These sensors are available for both wired and wireless communication with the wireless sensors being either local mains or battery powered.

Dimensions (mm)

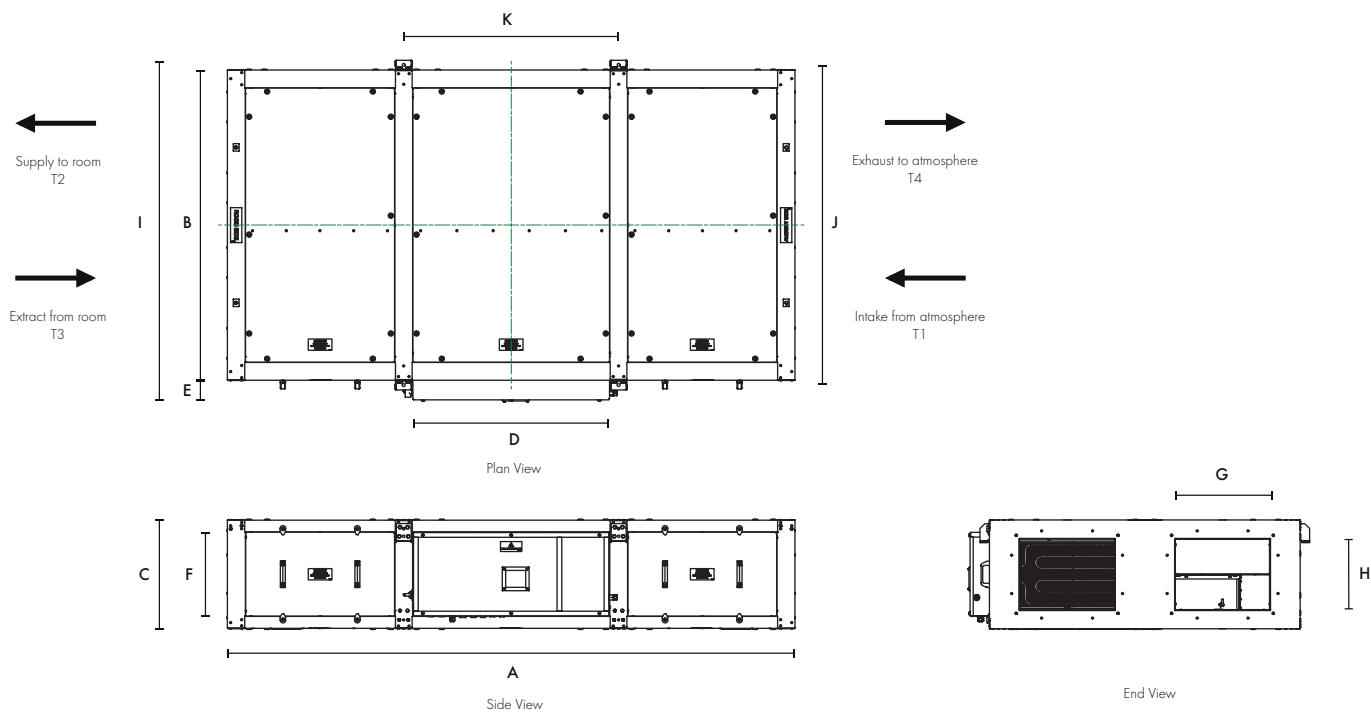

A (LENGTH)	B (WIDTH)	C (HEIGHT)	D	E	F	G	H	I	J	K	kg
2965	1319	620	1024	88	518	500	400	1446	1359	1097	470

Heat Recovery Efficiency

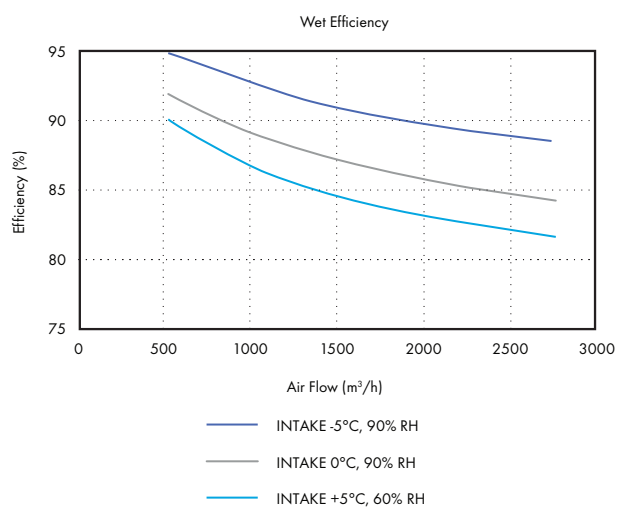
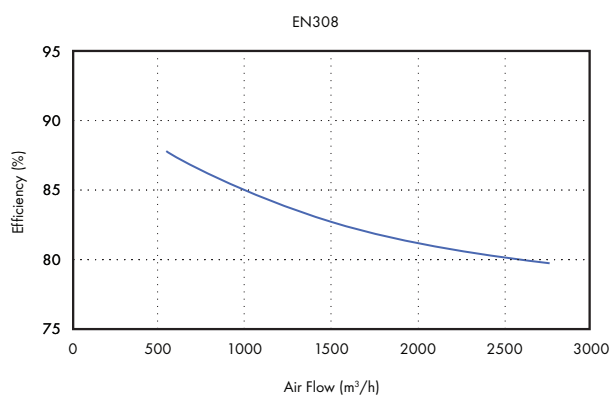

Performance Guide - Sentinel Apex HR21

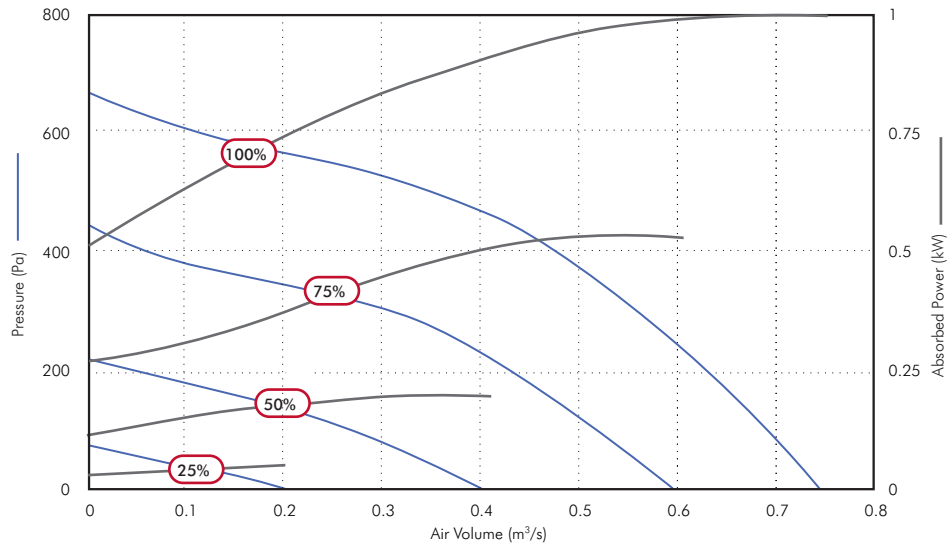

Speed	Airflow, m³/s @ Pa											Fans F.L.C.	Supply Voltage	Frost Heater	Unit Rated Current	
	0	25	50	100	150	200	250	300	400	500	600					
100%	m³/s	0.76	0.74	0.72	0.70	0.66	0.63	0.60	0.57	0.48	0.34	0.11	4.2A	230/1/50	7.8kW	39A
	SFP	1.31	1.36	1.40	1.45	1.52	1.59	1.64	1.72	2.00	2.53	6.08				
	kW	1.004	1.004	1.005	1.007	1.009	1.002	0.988	0.973	0.970	0.856	0.655				
75%	m³/s	0.60	0.59	0.56	0.52	0.49	0.43	0.38	0.31				4.2A	230/1/50	7.8kW	39A
	SFP	0.89	0.92	0.97	1.04	1.09	1.22	1.32	1.49							
	kW	0.538	0.540	0.542	0.541	0.534	0.522	0.498	0.459							
50%	m³/s	0.41	0.39	0.35	0.27	0.17	0.03						4.2A	230/1/50	7.8kW	39A
	SFP	0.53	0.55	0.62	0.75	1.08	5.22									
	kW	0.214	0.213	0.213	0.204	0.179	0.145									
25%	m³/s	0.20	0.15	0.08									4.2A	230/1/50	7.8kW	39A
	SFP	0.30	0.39	0.59												
	kW	0.061	0.057	0.050												

Sound Data - Sentinel Apex HR21

Speed	Test Mode	Sound Pressure level @ 3.0m dBA								
		63	125	250	500	1k	2k	4k	8k	
100%	Breakout	60	57	57	47	44	38	34	32	100%
	Exhaust T4	60	58	60	57	57	51	44	42	
	Extract T3	64	65	67	64	61	56	50	48	
	Intake T1	63	65	68	64	61	56	51	49	
	Supply T2	59	59	62	57	57	51	46	42	
75%	Breakout	54	57	50	42	37	34	28	25	75%
	Exhaust T4	54	58	52	49	50	44	37	33	
	Extract T3	58	65	63	56	53	49	43	41	
	Intake T1	57	63	61	58	53	48	43	41	
	Supply T2	52	54	52	48	50	44	39	34	
50%	Breakout	51	52	45	35	31	27	21	22	50%
	Exhaust T4	65	55	47	40	42	36	30	27	
	Extract T3	60	60	58	49	44	40	35	31	
	Intake T1	57	62	56	49	45	39	34	31	
	Supply T2	53	49	47	39	42	36	29	27	
25%	Breakout	48	39	42	24	22	17	18	22	25%
	Exhaust T4	48	35	35	29	31	23	20	25	
	Extract T3	57	44	44	37	34	29	21	26	
	Intake T1	53	43	46	37	32	26	20	25	
	Supply T2	44	34	34	28	30	22	19	25	

For full sound and performance data please use our Fan Selection Program www.vent-axia.com/fanselector/product/apex
 Sound data derived from independent testing at Sound Research Laboratories in accordance with EN ISO 3741:2010. Published dB(A) figures are free field sound pressure levels at 3m with spherical propagation at a reference level of 2×10^{-5} Pa. The inlet/outlet sound power level spectra figures are dB with a reference of 10^{-12} watts.

Accessories

Attenuator



Single skinned attenuators purpose designed for the Apex Heat Recovery range to minimise in duct noise. Attenuators are supplied in standard lengths of 900mm, 1200mm and 1500mm, constructed from Galvanised steel with profiled perforated sheet internal, mineral wool sound absorbing material and 30mm profiled flanges for duct and unit mounting. Data has been obtained by testing in accordance with BS EN ISO7235:2009.

Stock Ref.	Dimensions (mm)			kg	Insertion Loss dB								m ³ /hr @ Pa					
	Length	Width	Height		63	125	250	500	1k	2k	4k	8k	300	600	1000	1500	2000	3000
ATT900-HR21	900	500	400	25	3	7	11	20	28	21	13	8	1	2	5	11	19	43
ATT1200-HR21	1200	500	400	32	4	9	15	26	35	26	15	10	1	2	5	12	21	47
ATT1500-HR21	1500	500	400	46	5	11	19	33	45	31	18	11	1	2	5	12	22	50

Duct mounted Heating / Cooling



Rectangular Duct mounted heater battery with either electric heating complete with integral thyristor controls, or LPHW water heating, each designed to provide approximately 10°C temperature rise. Chilled water cooler also available with integral condensate tray. Note waterside controls are not included.

Stock Ref.	Type	Dimensions (mm)			kg	Heater rating kW	Electrical supply		Water Temp			m ³ /hr @ Pa					
		Length	Width	Height			Flow	Return	Connection	300	600	1000	1500	2000	3000		
EHB-HR21	HR 21 Duct mounted Rectangular electric heater with controls	300	500	400	10	7.50	230/1/50	N/A	N/A	N/A	1	2	5	12	21	47	
HWB-HR21	HR 21 Duct mounted Rectangular LPHW heating battery	200	500	400	10	7.03	N/A	80°C	60°C	1/2"	1	2	5	12	21	47	
CWB-HR21	HR 21 Duct mounted Rectangular water cooling battery	200	500	400	10	8.65	N/A	6°C	12°C	3/4"	1	2	5	12	21	47	

Roof Assembly

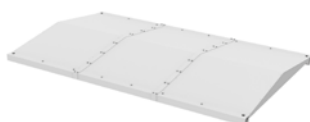

Stock Ref	Length mm	Width mm	Height mm	Weight kg
WRF-HR21	2965	1455	95	63

Transformation Piece



Rectangular to round transformation piece designed to fix directly to the unit or any of the specific HR21 duct accessories to enable connection to 400mm round ducting.

Stock Ref	Length mm	Width mm	Height mm	Weight kg
497224	325	500	400	5

Intake / Exhaust Cowl



Weather inlet/discharge cowl for external mounting (one required for each airstream).

Stock Ref	Length mm	Width mm	Height mm	Weight kg
497208	494	502	510	9

Flexible Connection



Stock Ref	Length mm	Width mm	Height mm	Weight kg
497021	130	500	400	4

CONTROLS & SENSORS



Basic On-Board Control

- Unit integrated 2 line LCD Display
- Accessible on the unit
- Basic monitoring and commissioning functions
- Wired sensor connection

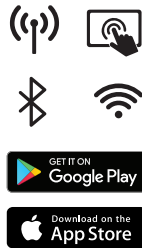

Digital Remote Control with Wireless Interface

- Custom LCD screen with Cap touch button.
- Surface mounted
- RS485 Wired
- App connectivity via Bluetooth or Wi-Fi
- Wireless sensor connections
- Expanded monitoring and commissioning functions

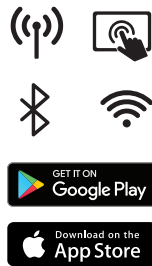

New Vent-Axia Connect App Control

- Bluetooth and Wi-Fi connectivity
- Wireless sensor connection and setup
- Comprehensive monitoring and commissioning
- Ease of control/setup

BMS connectivity provided on the unit as standard.

- Modbus - Bi-Directional via RS485
- Bacnet - Bi-Directional via RS485
- SD card slot for easy transfer/recording of settings

Controls connectivity provided on the units as standard.

- 0-10 V input
 - 5 assignable inputs
 - 24V output to power sensor
- Switch inputs
 - 2 On/Off (Manual operation and Fire)
 - 3 Min/Max
 - 24V output to power sensor
- NO/NC Filter condition
- NO/NC Run / Fault indicator
- Twin external shutoff damper activation



0-10V – Internal Temp and Humidity - Wired

Sensor that measures the Internal temperature and relative humidity levels within the room and communicates to the compatible system, using the 0-10v output.

- Dimensions (H x W x D) (mm) 90 x 90 x 17
- 24V Power supply required
- Temperature range 0~60°C
- Relative humidity range 0-90% RH
- Compatible with standard single gang or surface mounted pattress box
- Status LED indicator for pairing, health check, faults & air quality traffic light index
- 0-10v Wired Communication

Model

24V Temp/RH 0-10V

Stock Ref

496428



0-10V CO₂ – Temperature and Humidity - Wired

Room-mounted CO₂ sensor with 0-10v signal output powered by an external 24V supply.

- Dimensions (H x W x D) (mm) 90 x 90 x 17
- 24V Power supply required
- Temperature range 0~60°C
- Relative humidity range 0-90% RH
- CO₂ range 0-2000PPM
- Compatible with standard single gang or surface mounted pattress box
- Status LED indicator for pairing, health check, faults & air quality traffic light index
- 0-10v Wired Communication

Model

24V CO₂ (+RH) 0-10V

Stock Ref

496432

Mains powered sensors



240V – Internal Temperature and Humidity - Wireless

Room-mounted humidity and temperature sensor for wired or wireless communication with a compatible system. Using an in-built RF 868 MHz (Wireless radio frequency), or RS485 (Wired connection) communication method whilst being powered by a local 240V supply.

- Dimensions (H x W x D) (mm) 90 x 90 x 17
- Power supply 240V
- Temperature range 0~60°C
- Relative humidity range 0-90% RH
- Wireless range 20m closed/100m open
- RF 868MHz Wireless or RS485 Wired communication
- Status LED indicator for pairing, health check, faults & air quality traffic light index

Model

240V Temp/RH RS485 & RF868

Stock Ref

496429



240V CO₂ – Temperature and Humidity - Wireless

Room-mounted CO₂ sensor for wired or wireless communication with a compatible system. Using an in-built RF 868 MHz (Wireless radio frequency), or RS485 (Wired connection) communication method whilst being powered by a local 240V supply.

- Dimensions (H x W x D) (mm) 90 x 90 x 17
- Power supply 240V
- Temperature range 0~60°C
- Relative humidity range 0-90% RH
- CO₂ Range 0-2000 PPM
- Wireless range 20m closed/100m open
- RF 868MHz Wireless or RS485 Wired communication
- Status LED indicator for pairing, health check, faults & air quality traffic light index

Model

240V CO₂ (+Temp & RH) RS485 & RF868

Stock Ref

496433



240V PIR Sensor - Wireless

Room-mounted PIR sensor for wired or wireless communication with a compatible system. Using an in-built RF 868 MHz (Wireless radio frequency), or RS485 (Wired connection) communication method whilst being powered by a local 240V supply. Room-mounted presence detector for min/max or on/off control. Wall or ceiling mounting

- Dimensions (H x W x D) (mm) 90 x 90 x 17
- Power supply 240V
- 5-25min run on timer
- PIR Range 3m
- Wireless range 20m closed/100m open
- RF 868MHz Wireless or RS485 Wired communication

Model

240V PIR Sensor

Stock Ref

496438



240V - 4 Speed Switch with Temperature and Humidity - Wireless

Room-mounted Speed Switch for wireless communication with a compatible system. Using an in-built RF 868 MHz (Wireless radio frequency) communication whilst being powered by a local 240V supply.

- Dimensions (H x W x D) (mm) 90 x 90 x 17
- Power Supply 240V
- Temperature range 0~60°C
- Relative humidity range 0-90% RH
- Wireless range 20m closed/100m open
- RF 868MHz Wireless
- Status LED indicator for pairing, health check and fault conditions
- Available in Black or White, image for illustration only

Model

240V Powered White Speed Switch

240V Powered Black Speed Switch

Stock Ref

496620

497693



240V - 4 Speed Switch with Temperature and Humidity - Wired

Room-mounted Speed Switch for wired communication with a compatible system. Using an in-built RS485 communication method powered by a local 240V supply.

- Dimensions (H x W x D) (mm) 90 x 90 x 17
- Power Supply 240V
- Temperature range 0~60°C
- Relative humidity range 0-90% RH
- Status LED indicator for pairing, health check and fault conditions
- Available in Black or White, image for illustration only
- RS485 Wired Connection

Model

240V Powered White Speed Switch

240V Powered Black Speed Switch

Stock Ref

496621

497697



240V - AIM Alarm Interface Module including Temperature and Humidity - Wireless

Room-mounted AIM for wired or wireless communication with a compatible system. Using an in-built RF 868 MHz (Wireless radio frequency), or RS485 (Wired connection) communication method whilst being powered by a local 240V supply.

- Dimensions (H x W x D) (mm) 90 x 90 x 17
- Power supply 240V
- Temperature range 0~60°C
- Relative humidity range 0-90% RH
- Wireless range 20m closed/100m open
- RF 868MHz Wireless or RS485 Wired communication
- Status LED indicator for pairing, health check and fault conditions

Model

240V Alarm Interface Module

Stock Ref

496441



IMPROVING INDOOR AIR QUALITY SINCE 1936

At Vent-Axia we pride ourselves on a long tradition of innovation. Driving this innovation is the desire to create healthier indoor environments in an energy efficient way.

The real world requirements of our customers drives us to develop best in class products that are easy to install, need minimal maintenance and provide quiet, energy efficient ventilation.

In addition, we have the largest sales and support teams of any ventilation company in the UK, dedicated to providing complete solutions with technical and design support.

Why choose Vent-Axia

Vent-Axia supplies ventilation to countries around the world, whose building regulations demand the most effective, sustainable and energy efficient ventilation solutions.

We are with you all the way

- Unparalleled customer service
- Industry leading design support
- Providing support and solutions on-site

With the widest distribution network of any manufacturer in the UK we pride ourselves on having products available when and where you need them.

Product Solutions

- Whatever the product category, we have the most energy efficient solutions available
- Unique solutions designed to fit in all buildings
- With absolute focus on the end user we work hard to produce the quietest, most comfortable products for occupiers

VENT-AXIA CONTACT NUMBERS

Free technical, installation and sales advice is available

Sales Tel:	0344 856 0590
Sales Fax:	01293 565169
Tech Support Tel:	0344 856 0594
Tech Support Fax:	01293 532814
Web:	www.vent-axia.com
Email:	sales@vent-axia.com

Supply & Service

All sales made by Vent-Axia Limited are made only upon the terms of the Company's Conditions of Sale, a copy of which may be obtained on request. As part of the policy of continuous product improvement Vent-Axia reserves the right to alter specifications without notice.



Download our Knowledge Hub app - Your new pocket expert.

Search, View, Share - It's that easy!



Made in Britain

1223