

# Sentinel

## Totus 2 D-ERV

Installation, Operation & Maintenance



### Stock Ref. N°

TOTUS2MINI  
TOTUS2MINI/CP  
TOTUS2MIDI  
TOTUS2MIDI/CP  
TOTUS2MAXI  
TOTUS2MAXI/CP

***Vent-Axia***®

PLEASE RETAIN THESE INSTRUCTIONS WITH THE PRODUCT.



## IMPORTANT



**PLEASE READ THESE INSTRUCTIONS CAREFULLY BEFORE COMMENCING INSTALLATION AND LEAVE THEM WITH THE END USER.**

1. THESE UNITS MUST BE SITED AND CONNECTED IN ACCORDANCE WITH CURRENT IEE REGULATIONS, BS7671 (UK) OR THE APPROPRIATE STANDARDS IN YOUR COUNTRY.
2. INSTALLATION SHOULD BE BY A QUALIFIED ELECTRICIAN AND INSTALLER.
3. ALL REGULATIONS AND REQUIREMENTS MUST BE STRICTLY FOLLOWED TO PREVENT HAZARDS TO LIFE AND PROPERTY, BOTH DURING AND AFTER INSTALLATION, AND DURING ANY SUBSEQUENT SERVICING AND MAINTENANCE.
4. THESE UNITS MUST BE EARTHED.
5. SITE THE UNIT AWAY FROM DIRECT SOURCES OF HEAT. AMBIENT TEMPERATURE RANGE 10 TO 40°C.
6. WHEN INSTALLING UNIT, TAKE CARE NOT TO DAMAGE ELECTRICAL OR OTHER HIDDEN UTILITIES.
7. CHECK THE DETAILS ON THE RATING LABEL FOR CORRECT VOLTAGE AND ELECTRICAL RATING.
8. THE INSTALLER IS RESPONSIBLE FOR THE INSTALLATION AND ELECTRICAL CONNECTION OF THE SENTINEL SYSTEM ON SITE. IT IS THE RESPONSIBILITY OF THE INSTALLER TO ENSURE THAT THE EQUIPMENT IS SAFELY AND SECURELY INSTALLED AND LEFT ONLY WHEN MECHANICALLY AND ELECTRICALLY SAFE.
9. DUE TO THE WEIGHT OF THE UNITS, IT IS RECOMMENDED THAT MULTIPLE PERSONS ARE INVOLVED IN THE INSTALLATION. AT ALL TIMES, INSTALLATION PRACTICES MUST COMPLY WITH RELEVANT HEALTH AND SAFETY LEGISLATION.
10. SENTINEL AIR HANDLING UNITS ARE DESIGNED AND SPECIFIED FOR USE WITH VENT-AXIA CONTROLS, DAMPERS, GRILLES AND ACCESSORIES.
11. THIS APPLIANCE IS NOT INTENDED FOR USE BY YOUNG CHILDREN OR INFIRM PERSONS WITHOUT SUPERVISION.
12. YOUNG CHILDREN SHOULD BE SUPERVISED TO ENSURE THAT THEY DO NOT PLAY WITH THE APPLIANCE.
13. PRECAUTIONS MUST BE TAKEN TO AVOID THE BACKFLOW OF GASES INTO THE ROOM, FROM THE OPEN FLUE OF GAS OR OTHER FUEL BURNING APPLIANCES.
14. THIS UNIT SHOULD NOT BE USED IN A GREASE-LADEN ATMOSPHERE. IF THE UNIT IS TO BE USED IN A GREASE-LADEN ATMOSPHERE SUITABLE DUCT FILTRATION SHOULD BE USED.

## PRODUCTS COVERED

**Thank you** for purchasing Sentinel Totus 2 D-ERV.

This document describes the installation and commissioning of your equipment to help get your equipment up and running. It also provides essential maintenance and troubleshooting information to assist the operation and prolong the lifetime of your equipment.

This document covers the Sentinel Totus 2 D-ERV series detailed in the following table.

*Table 1: Products Covered by this Document*

Model Number	Description
TOTUS2MINI	Totus 2 Mini
TOTUS2MINI/CP	Totus 2 Mini/ Constant Pressure
TOTUS2MIDI	Totus 2 Midi
TOTUS2MIDI/CP	Totus 2 Midi/Constant Pressure
TOTUS2MAXI	Totus 2 Maxi
TOTUS2MAXI/CP	Totus 2 Maxi/Constant Pressure

See *Technical Specification* for details of these models.

# About this Document

## CONTENTS

<b>Product Description</b>	<b>4</b>
Sentinel Totus 2 D-ERV.....	4
<b>Technical Specification</b>	<b>6</b>
Sentinel Totus 2 D-ERV Technical Specification.....	6
Commissioning Record.....	6
Dimensions.....	7
<b>Installation</b>	<b>11</b>
Installing Your Energy Recovery Ventilation System.....	11
Before Installing Your Equipment.....	12
Physical Installation.....	13
Electrical Installation.....	17
Switching On/Off.....	23
<b>Commissioning</b>	<b>24</b>
Commissioning Your Energy Recovery Ventilation System.....	24
Commissioning Screens.....	26
The Settings Code.....	37
Writing Down the Settings Code.....	38
Default Settings.....	39
<b>Restoring Settings</b>	<b>40</b>
Restore Settings Screens.....	40
<b>Operation and Monitoring</b>	<b>42</b>
About Operation and Monitoring.....	42
Status Monitoring Screens.....	42
<b>Maintenance</b>	<b>46</b>
Caring for Your Unit.....	46
3-Monthly Maintenance.....	46
12-Monthly Maintenance.....	46
5-Yearly Maintenance.....	46
<b>Removal/Replacement of Parts</b>	<b>47</b>
Cover Removal/Replacement.....	47
Filter Removal/Replacement (Roof-Mounted).....	49
Filter Removal/Replacement (Ceiling-Mounted).....	49
Motor Removal/Replacement (Roof-Mounted).....	50
Motor Removal/Replacement (Ceiling-Mounted).....	51
Float Switch Removal/Replacement (Roof-Mounted).....	52
Float Switch Removal/Replacement (Ceiling-Mounted).....	53
Condensate Pump Removal/Replacement (Roof-Mounted).....	54
Condensate Pump Removal/Replacement (Ceiling-Mounted).....	55
Filter Removal/Replacement (Maxi).....	56
List of Spares.....	57
<b>Troubleshooting</b>	<b>58</b>
Diagnosing a Problem.....	58
Diagnostic Codes.....	58
Fault LED/Status Relay.....	59
Power Supply Troubleshooting.....	59
Airflow/Temperature Troubleshooting.....	60
Condensate Troubleshooting.....	61

<b>Appendix A: Glossary</b>	<b>62</b>
Terms and Abbreviations.....	62
<b>Appendix B: Options and Accessories</b>	<b>63</b>
Sentinel Totus.....	63
<b>Appendix C: Main Controller PCB Terminals</b>	<b>64</b>
Terminals.....	64

## Product Description

### Sentinel Totus 2 D-ERV

**Sentinel Totus 2 Demand Energy Recovery Ventilation (D-ERV)** is a heat recovery demand ventilation system designed to meet modern building management and control principles.

Employing a range of sensors to manage the system, demand is typically sensed by PIR, temperature, humidity, air quality, carbon dioxide sensors or other types of Vent-Axia proprietary sensors (see *Appendix B: Options and Accessories on page 63* for details).

It can respond to the ventilation requirements of a room by providing airflow only when it is required and at the level that is required, using only the energy that is needed, while recovering maximum energy from the extracted air and transferring it to the fresh supply air. This overcomes many of the drawbacks encountered with traditional fixed volume ventilation systems, which operate irrespective of the occupancy of the room, leading to over ventilation and a wasteful use of energy.

Note that the unit contains heaters, which automatically prevent the heat recovery cell from freezing and can also be used to “Top Up” the air temperature to the room.

### Models

- **Mini** designed to operate at airflows of up to 650 m<sup>3</sup>/hr at 150 Pa.
- **Midi** designed to operate at airflows of up to 1000 m<sup>3</sup>/hr at 150 Pa.
- **Maxi** designed to operate at airflows of up to 2000 m<sup>3</sup>/hr at 150 Pa

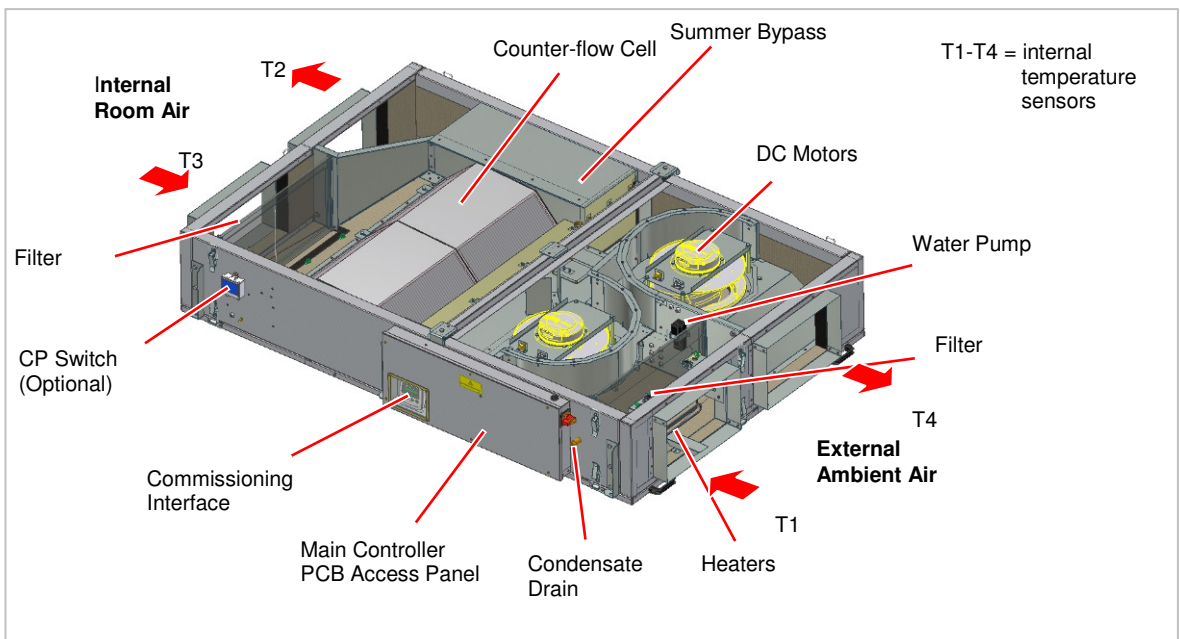

Figure 1: Sentinel Totus Mini & Midi 2 D-ERV

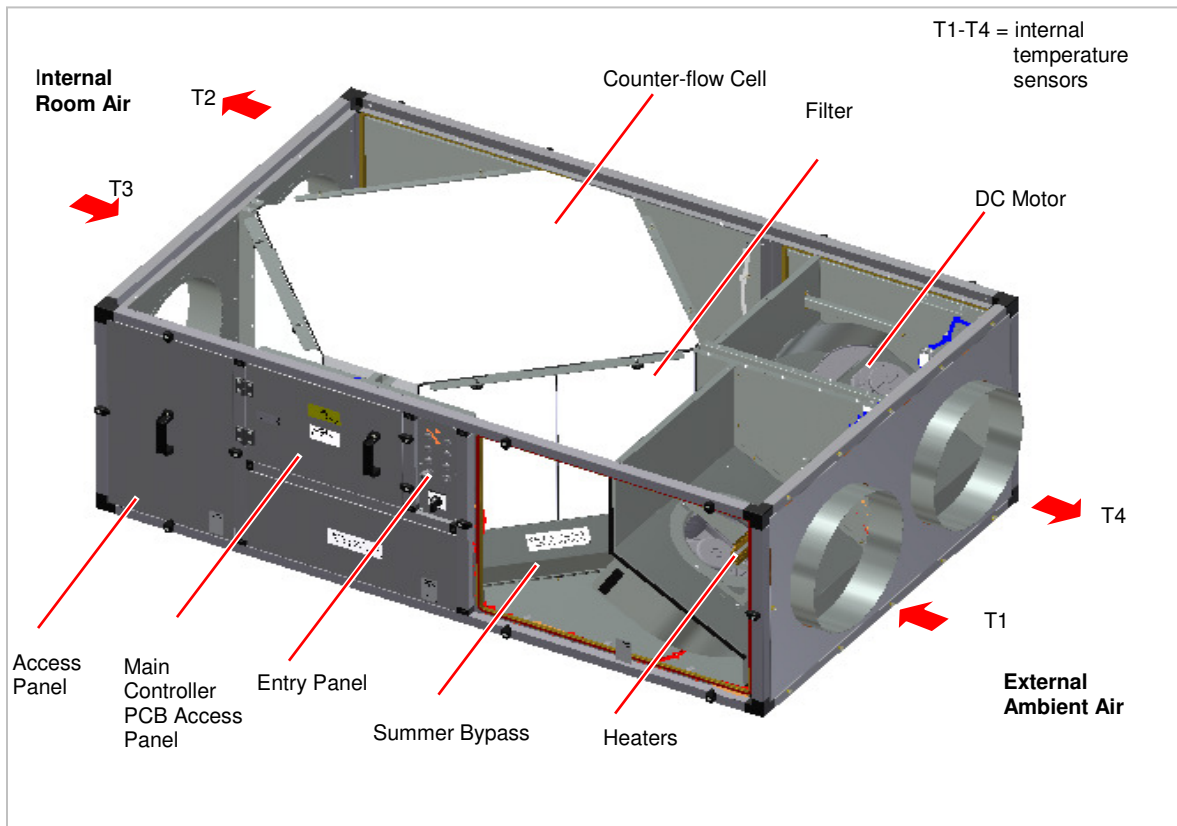

Figure 2: Sentinel Totus 2 Maxi D-ERV

## Technical Specification

### Sentinel Totus 2 D-ERV Technical Specification

Performance	Mini	Midi	Maxi
<b>Airflow (nominal)</b>	650 m <sup>3</sup> /hr at 150 Pa	1000 m <sup>3</sup> /hr at 150 Pa	2000 m <sup>3</sup> /hr at 150 Pa
<b>Power</b>			
<b>AC Voltage Input</b>	220-240 V ac (single phase)		
<b>AC Frequency Input</b>	50/60 Hz nominal		
<b>Supply Fuse or Cct Breaker</b>	16 A	16 A	32A
<b>Rated Current</b>	12 A	12 A	20A
<b>Rated Power</b>	1825 W	2500 W	5000W
<b>Total Fan Power (max.)</b>	325 W	500 W	1000W
<b>Total Frost Heater (max.)</b>	1.5 kW	2 kW	4kW
<b>Power (standby)</b>	0.6 W	0.6 W	0.6 W
<b>DC Voltage Output</b>	24 V dc (18-30 V dc) at 350 mA (max.) for switches and sensors		
<b>Battery</b>	<i>See Table 6: 5 12-Monthly Maintenance on page 46</i>		
<b>Product Fuses</b>			
<b>Power PCB</b>	<i>See Table 11: Internal Fuse Values and Types on page 60</i>		
<b>Main Controller PCB</b>	<i>See Table 11: Internal Fuse Values and Types on page 60</i>		
<b>Physical</b>			
<b>Height/Width/Depth</b>	<i>Mini, Midi &amp; Maxi see page 7 and 8</i>		
<b>Weight</b>	145 kg	167 kg	250 kg
<b>Environmental</b>			
<b>IP Rating - Unit</b>	IPX4		
<b>IP Rating - Commissioning Interface</b>	IP42		
<b>Operating Temperature</b>	-10°C to +40°C		
<b>Operating Humidity</b>	0% to 95% (non-condensing) – weatherproof unit option		
<b>Storage Temperature</b>	-10°C to +40°C		
<b>Storage Humidity</b>	0% to 95% (non-condensing)		
<b>Condensate Pump</b>	12 m max head, 25 m max horizontal distance, but 150 max head X distance		
<b>Software Version</b>	V25		

For all other technical details, please see the Product Catalogue or our website at [www.vent-axia.com](http://www.vent-axia.com).

### Commissioning Record

Record the unit commissioning settings here.

Date	Settings Code	Who

For details of the settings code, see

*The Settings Code on page 37.*

# Technical Specification

## Dimensions

Model	Dimensions (mm)																	
	a	b	c	d	e	f	g	h	i	j	k	l	m	n	o	p	q	r
Mini	1800	1920	352	940	900	450	250	-	60	142	174	962	153	42	188	375	72	1656
Midi	1900	2020	350	1290	1250	538	400	250	60	220	175	1315	147	47	332	526	72	1758
Maxi	1800	1925	660	1212	1130	530	400	-	60	710	578	-	-	-	-	635	-	-

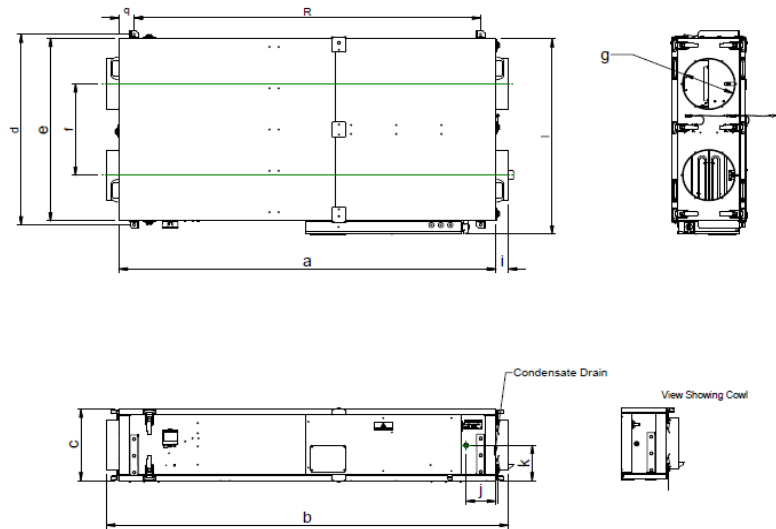

## Mini

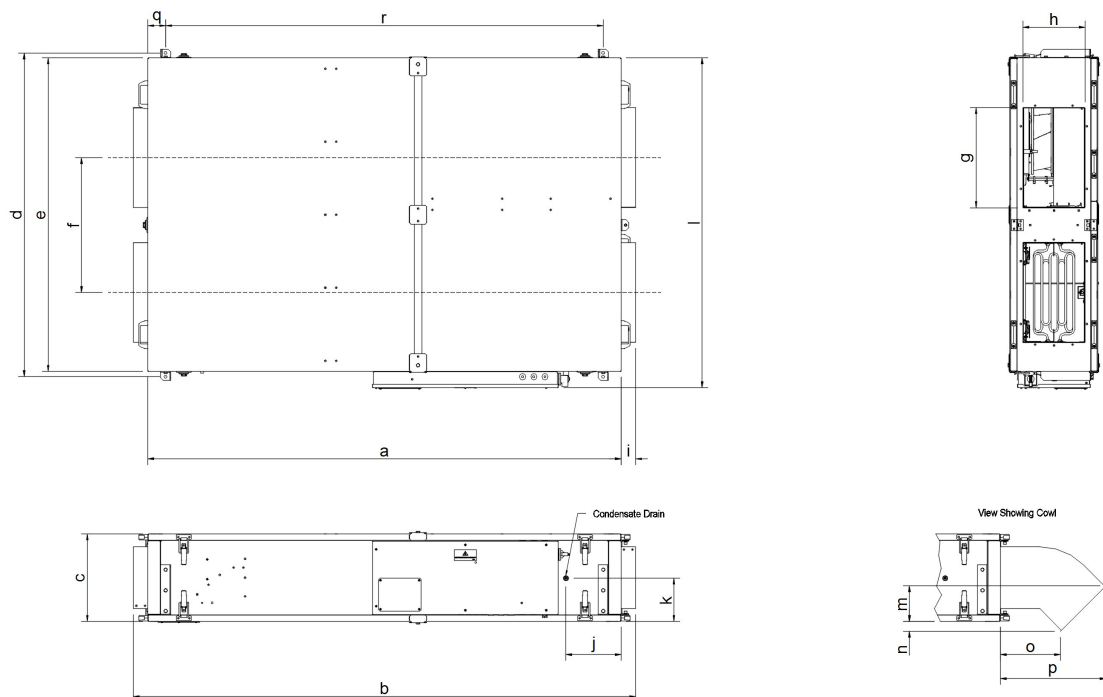

## Midi

# Technical Specification

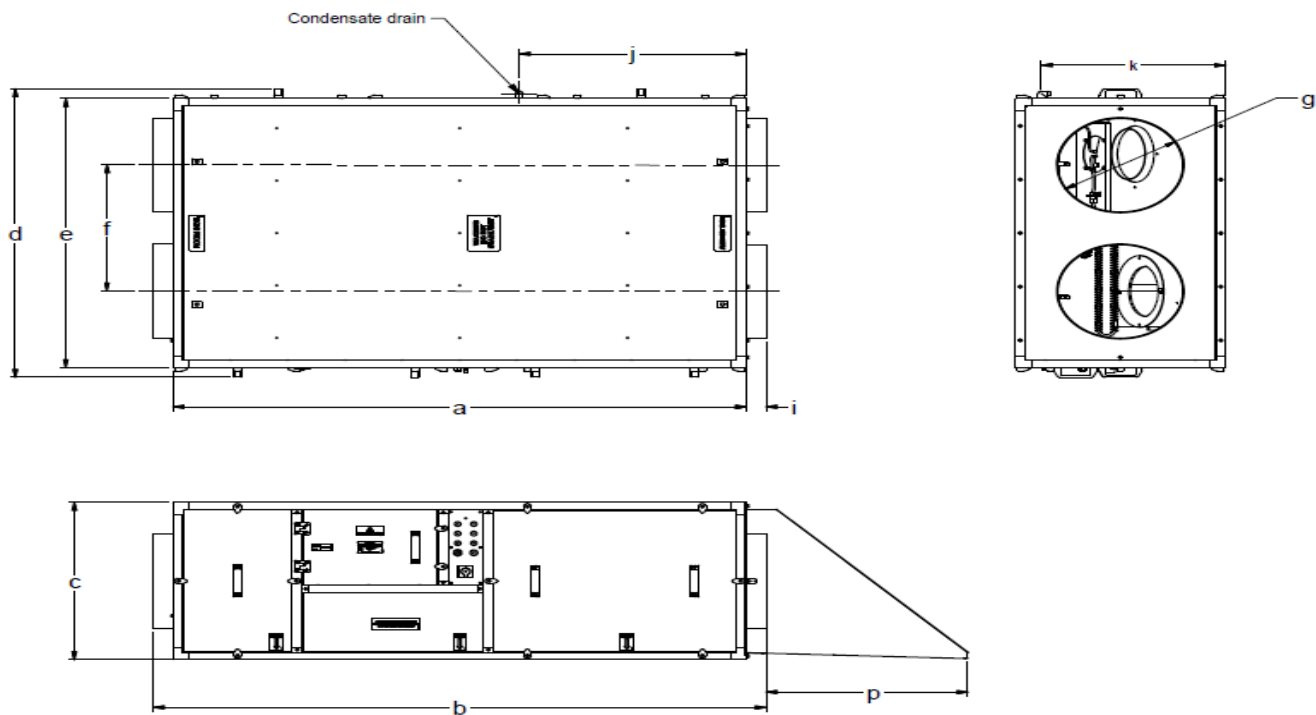

## Maxi

Figure 3: Unit Dimensions for Mini, Midi & Maxi



## Filter and Control Box Access

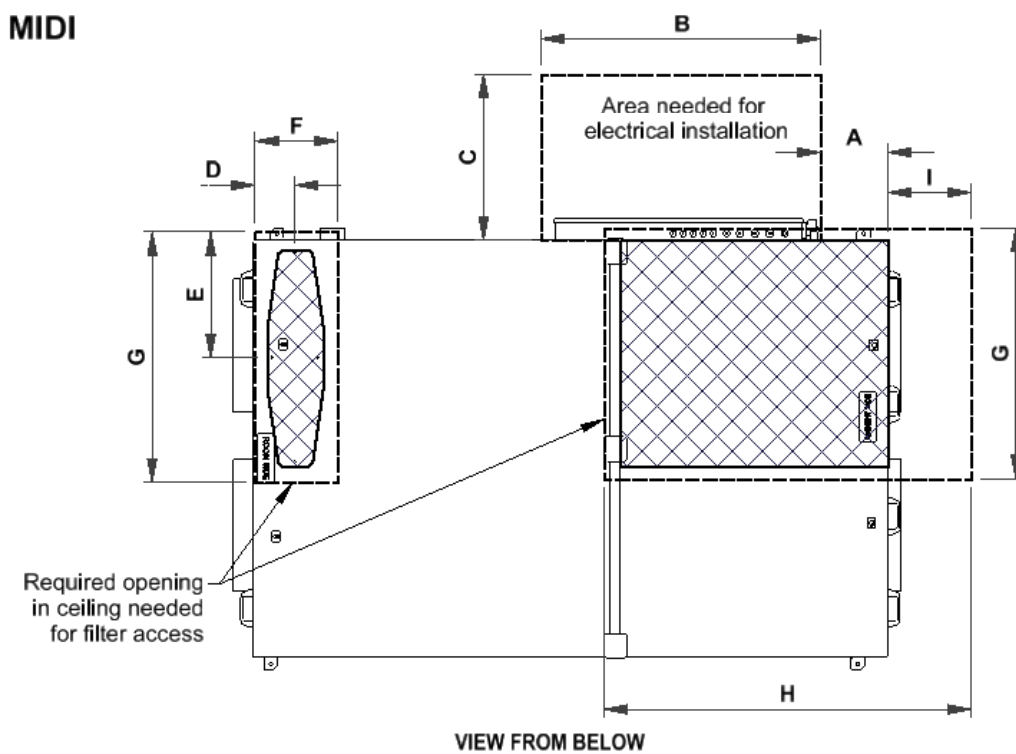
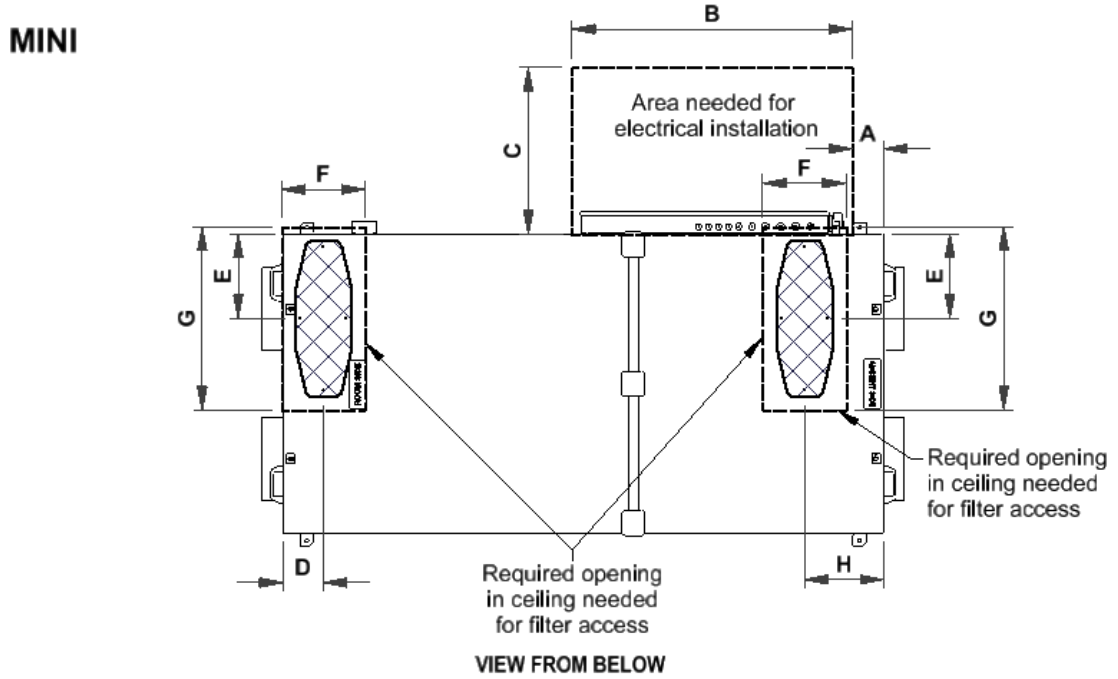

Dimensions (mm)									
MODEL	A	B	C	D	E	F	G	H	I
MINI	95	840	500	120	253	250	550	238	-
MIDI	200	840	500	120	377	250	750	1100	250

 Remove for filter access

## MAXI

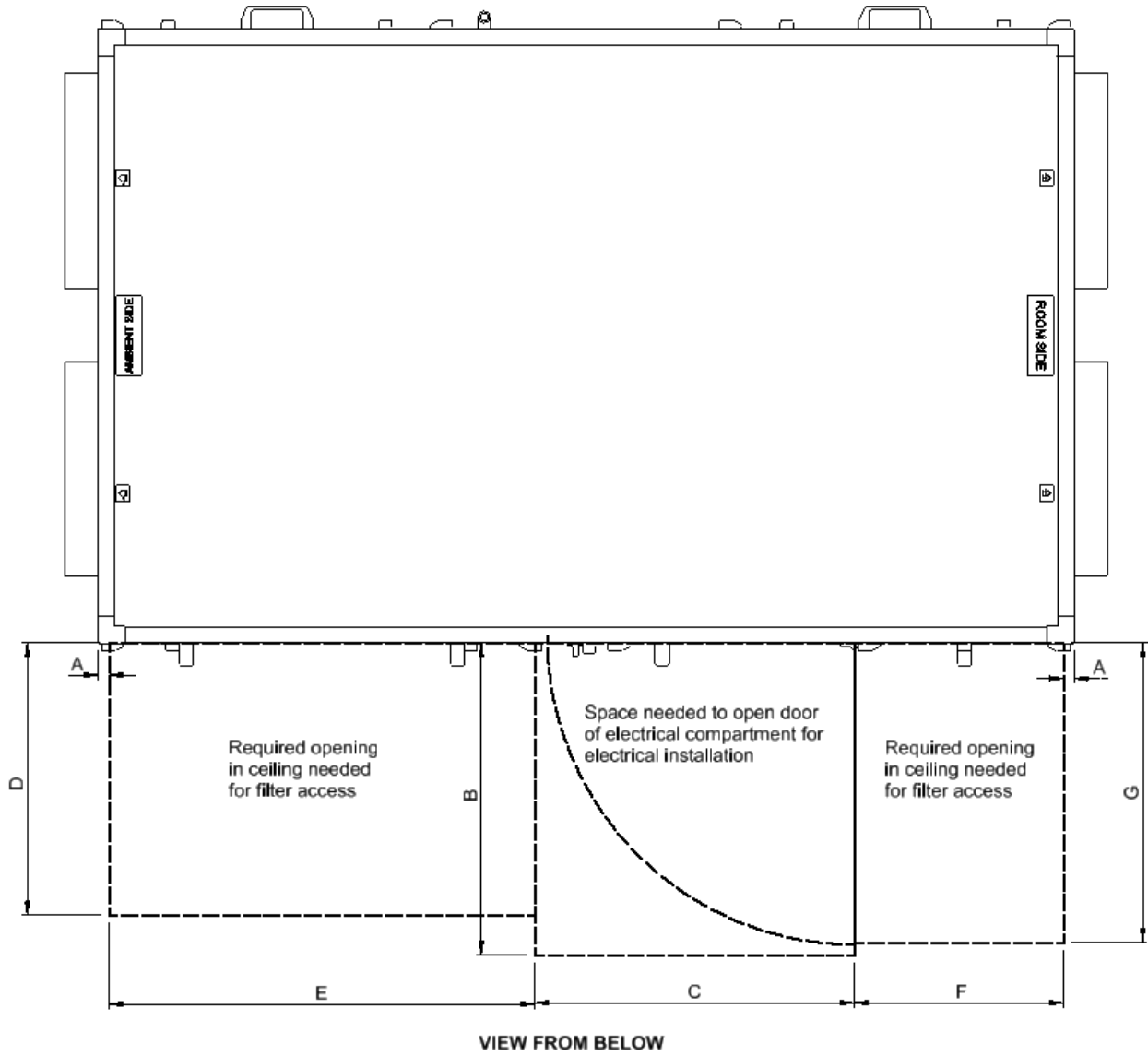

Dimensions (mm)						
A	B	C	D	E	F	G
20	580	590	500	790	390	550

# Installation

## Installing Your Energy Recovery Ventilation System



**WARNING**

**THIS EQUIPMENT PRESENTS ELECTRICAL, MECHANICAL AND NOISE HAZARDS. FAILURE TO USE SAFE WORKING PRACTICES AND OBSERVE THE RELEVANT REGULATIONS MAY RESULT IN DEATH OR SERIOUS INJURY.**

The following instructions are intended to help prevent and/or minimize potential hazards and should be carried out only by a qualified electrician and installer.

### How to Install Your Energy Recovery Ventilation System

The figure below summarises the instructions given in the following paragraphs.

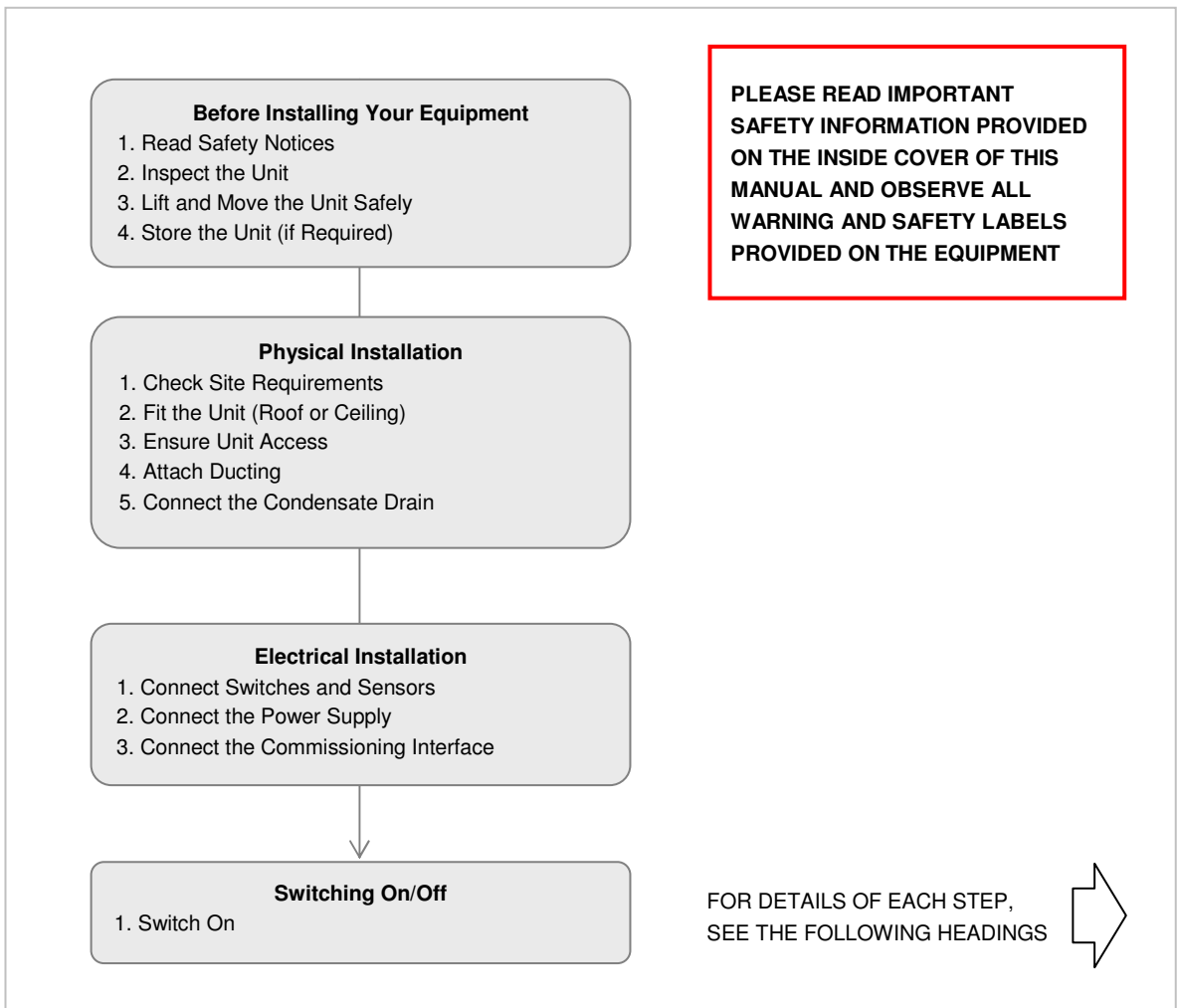

Figure 4: Installation Overview

## Before Installing Your Equipment

### Read Safety Notices

**The equipment must be handled carefully and thoughtfully to prevent safety hazards and damage. Ensure the personnel designated to install the unit have the appropriate skills and knowledge.**

Before commencing installation, please read and observe the safety notices given in the inside front cover of this manual.

### Inspect the Unit

The unit is supplied on a pallet, shrink-wrapped in polythene. When taking delivery of the unit, check the items delivered against the enclosed delivery note. Inspect the unit for damage in transit. If in doubt, contact Customer Services.

### Lift and Move the Unit Safely

This weight of this unit is detailed in the Technical Specification *on page 6*. Always use appropriate lifting techniques and appliances when moving heavy equipment. A forklift truck, crane or similar lifting gear is required to lift and move the unit. Support the unit under the 3 support points, as shown in *figures 5, 6*.

### Store the Unit (if Required)

If the unit is to be stored for a long period of time the fan impellers must be rotated by hand at monthly intervals to prevent hardening of the lubricant and corrosion or static indentation of the bearings.

If the unit has been stored, it is recommended that before installation, the resistance to earth should be measured. If found to be less than 2 M $\Omega$ , the unit should be left in a warm dry room for 24 hours and re-measured before applying mains voltage. If the resistance is still less than 2 M $\Omega$ , there is likely to be a fault.

The unit must be stored in clean, dry conditions.

## Physical Installation

### Check Site Requirements

Before installing the unit, check that the physical and environmental conditions for the site meet, or exceed, the requirements detailed in the Technical specification *on page 6*.

**DO NOT install these fans in areas where the following may be present:**

- Excessive oil or grease laden atmosphere.
- Corrosive or flammable gases, fluids or vapours.
- Possible obstructions that will hinder removal.

### Fit the Unit (Roof or Ceiling)

The Mini or Midi units **MUST** be mounted horizontally to ensure drainage of the condensate tray. **DO NOT** mount this unit vertically. The Maxi unit must be installed on a 2° slope. See diagrams below.

Do not use this unit as a support for any other equipment.

Always use the appropriate fixings, supports, studs and hangers; and ensure that the unit is firmly and safely located.

#### *Roof Mounting the Unit*

The suggested method for roof mounting is to support the unit on six blocks. The support blocks should provide 150 mm clearance between the unit and the roof, thereby allowing sufficient room for the fitting of the weatherproof cowls, as shown in the figure below. The blocks should be positioned directly below the support brackets provided for ceiling mounting.

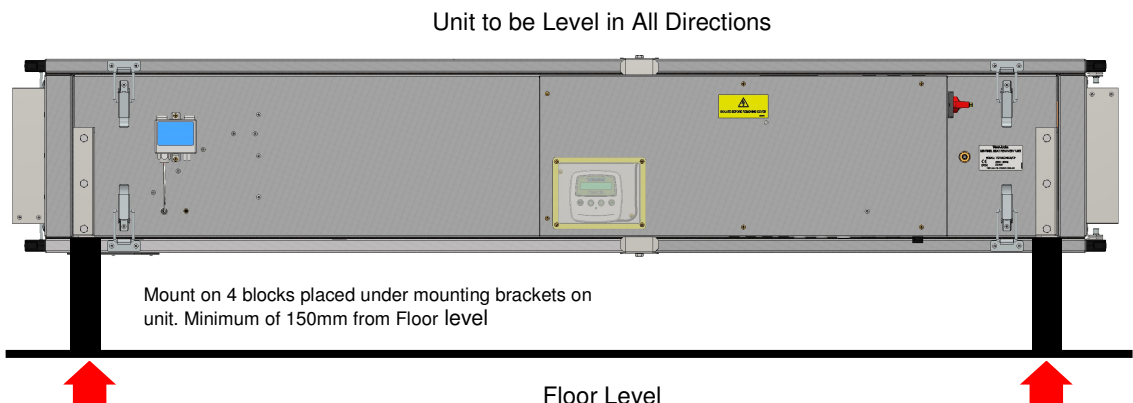

*Figure 5: Unit Roof Mounted for Mini & Midi (Recommended)*

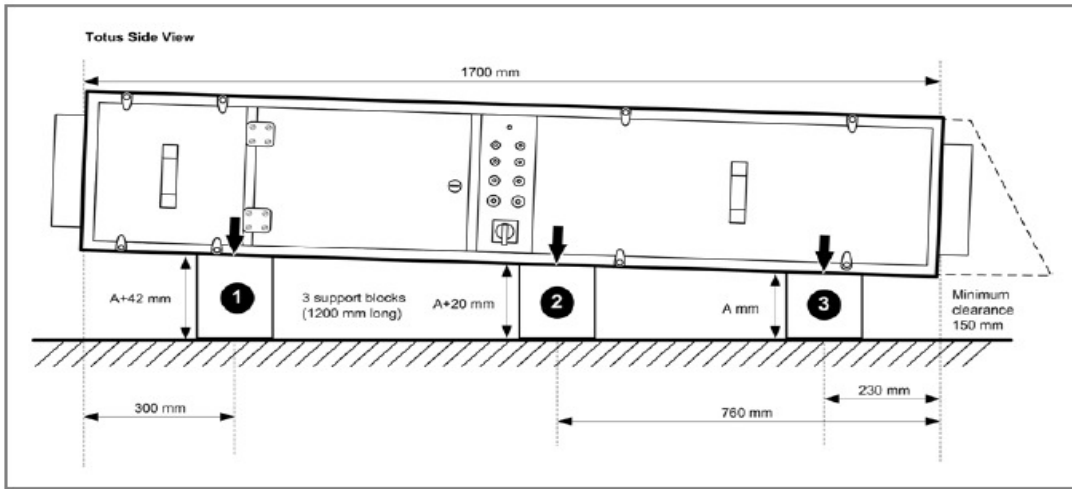

Figure 6: Unit floor or Roof Mounted for Maxi (Recommended)

If required, weatherproof cowls (see *Appendix B: Options and Accessories* on page 63) can be fitted at the ambient end (external intake and exhaust).

### Note

Any exposed ductwork must be insulated if the Totus 2 is mounted on a roof or other external position.

### Fitting the Weatherproof Cowl (If Required)

1. Ensure that the Totus 2 has been mounted with sufficient clearance available (150 mm) to fit the weatherproof cowls at the external ambient air end of the unit.

### Note

The weatherproof cowls are fitted at the same end as the motors.

2. Position each cowl over the flange around each opening, as shown in the figure below. Use sealant to seal the flange to the cowl to maintain the internal pressure and prevent water ingress.

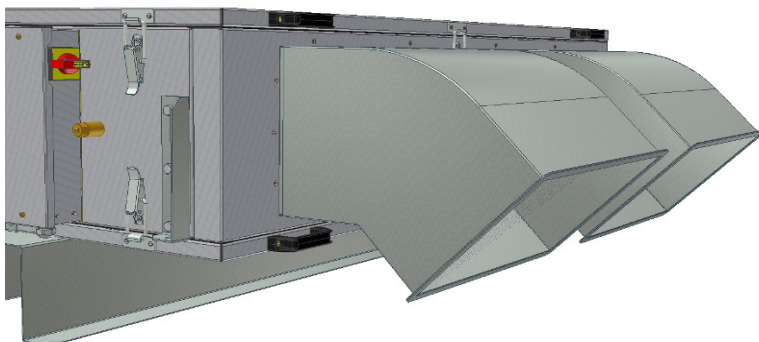

3. Secure each cowl to the chassis using 6 x no. 10 self-tapping screws.

Drill holes ( $\phi$  4)

## **Suspending the Unit from a Ceiling – Mini & Midi**

The unit is designed for stationary use and **MUST** always be mounted horizontally to ensure drainage of the condensate tray. **DO NOT mount this unit vertically.**

The unit provides **six** brackets, one at each corner and two half-way along the length of the unit, from which to suspended it. Ensure the drop rods & their attachment to the ceiling are of sufficient strength.

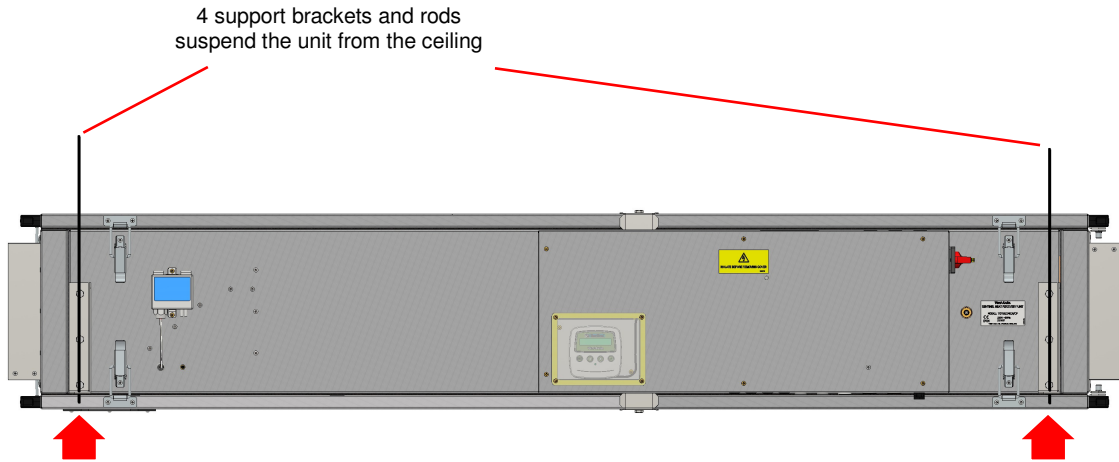

Figure7: Unit Suspended from Ceiling for Mini & Midi

## **Ensure Unit Access**

Ensure the unit is installed in such a way as to allow access to the control unit, connectors and filters (see *Filter Removal/Replacement (Ceiling-Mounted)* on page 49). Check the dimensions of the unit detailed in the *Technical Specification*.

Leave a gap of 500 mm to enable the Control Panel to be removed and to gain access to the Commissioning Interface and the Main Controller PCB.



Figure 8: Control Panel Access

On the opposite side of the unit a gap of 75 mm should be left to enable someone to be able to release the thumb catches when removing the top or bottom covers (see *Cover Removal/Replacement* on page 47).

## Suspending the Unit from a Ceiling – Maxi

The unit is designed for stationary use and **MUST** always be mounted horizontally with a 2° tilt on the long side (the motor end should be lower) and horizontally with no tilt on the short side, to ensure drainage of the condensate tray. **DO NOT** mount this unit vertically.

The unit must be suspended on six drop-rods and cradle are of sufficient strength to support the weight of the unit. Align that the drop-rods with the arrows with the sides of the units and ensure they are mounted 350 mm away from both the sides of the unit to allow opening of access panels.

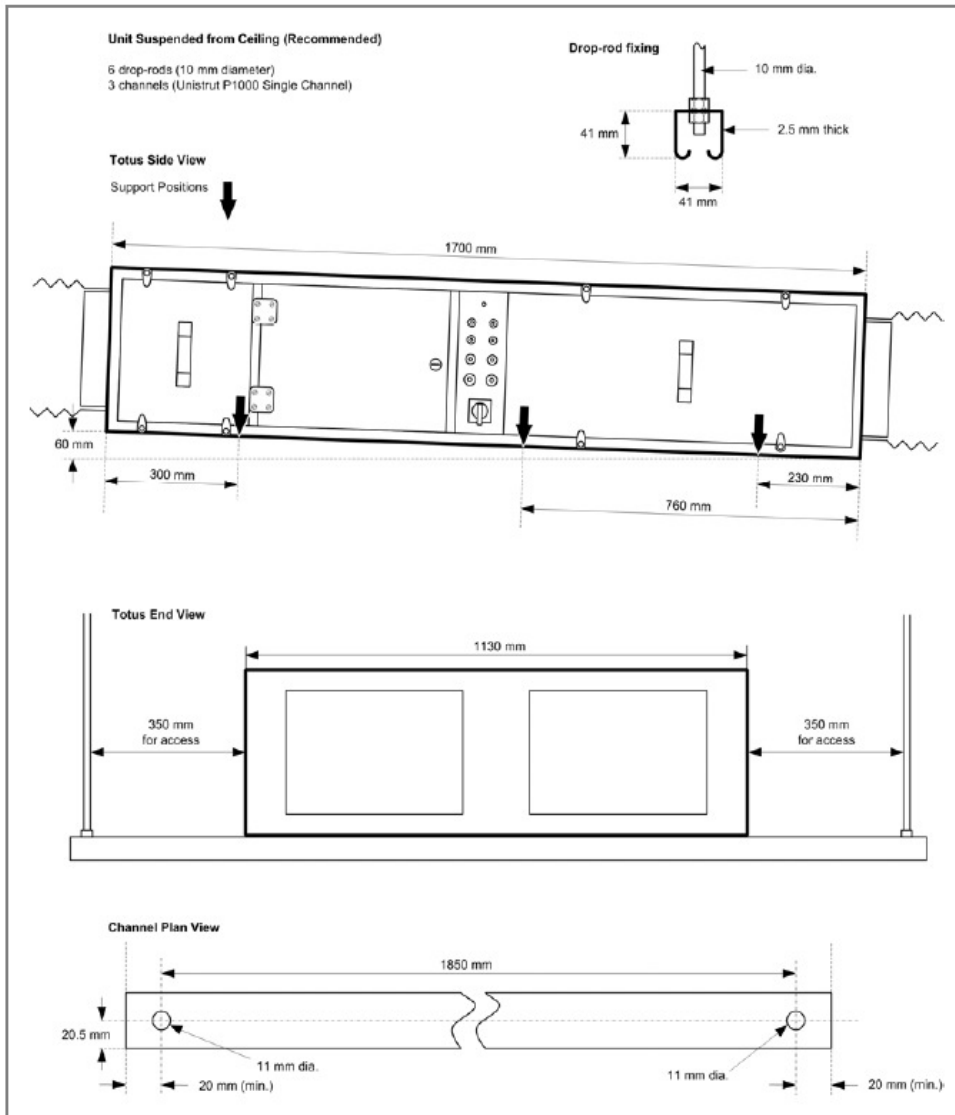

Figure 9: Unit suspended from ceiling for Maxi (Recommended)

## Ensure Unit Access

Ensure the unit is installed in such a way to allow access to the control unit and connectors check the dimensions of the unit detailed in the *technical specification*. Note that the control door requires a 350 mm space in order to open fully.



## Attach Ducting

### WARNING

**IF THIS EQUIPMENT IS RUN WITHOUT DUCTING FITTED, THERE IS A POTENTIAL HAZARD FROM ROTATING PARTS THAT CAN BE REACHED DURING OPERATION.**

Fit appropriate ducting to the unit in accordance with the supplied drawings for the building.

Fit flexible connectors adjacent to the unit. Ensure they are taut.

When fitting clamping bands to flexible connectors, ensure that the flexible connectors are pulled tight and the ducts are not misaligned.

The unit provide rectangular ducting interfaces. Fit adapters as necessary to connect to ducting with a circular cross-section.

In order to facilitate access to, and replacement of, the extract motor on the external/ambient side, a suitable, easily disconnected section of ducting should be fitted, if ducting is required, in installations where the unit is mounted internally.

## Connect the Condensate Drain

The unit should be mounted horizontally to ensure drainage of the condensate drain.

Use 10 mm pipe or flexible hose to connect to the condensate drain in order to carry away any water produced because of internal condensation. Ensure that the water is routed to a suitable outlet, which can be up to 12 m above the unit as there is an internal pump. This pipe should be insulated if installed in an area that could freeze, or fit a proprietary frost pipe heater.

## Electrical Installation

### Connect Switches and Sensors

Connect any required switches and/or sensors as recommended by the system designer in the drawings supplied by him.

A 24 V dc nominal (18-30 V dc) supply at 350 mA max is provided for powering switches and sensors, etc. Analogue signal returns must be 0-10 V dc with common ground for the instrument and cable screen at the control board.

The terminal connections provided by the Main Controller PCB for connecting to switches, sensors, etc., are shown below. Other terminals are connected as required at the factory. DO NOT disconnect any factory fitted connections.



## Connect the Power Supply



### WARNINGS

1. MAINS SUPPLY VOLTAGES (220-240 V AC) ARE PRESENT IN THIS EQUIPMENT WHICH MAY CAUSE DEATH OR SERIOUS INJURY BY ELECTRIC SHOCK. ONLY A QUALIFIED ELECTRICIAN OR INSTALLER SHOULD CONNECT THE POWER SUPPLY TO THIS UNIT.
2. THIS UNIT MUST BE CORRECTLY EARTHED IN ORDER TO PROVIDE OVERCURRENT AND EARTH FAULT PROTECTION.
3. DO NOT OVERLOAD WALL OUTLETS AND EXTENSION CABLES AS THIS MAY RESULT IN A RISK OF FIRE OR ELECTRIC SHOCK.
4. ENSURE THE UNIT ISOLATOR IS SET TO OFF AND LOCKED IN POSITION BEFORE REMOVING THE UNIT COVERS.

Check the *Technical Specification* for the voltage, current and fusing information relevant to this product.

This unit is designed for operation either from a single-phase alternating current source (220-240 V ac) or from three single-phase alternating current sources (220-240 V ac) that will allow you to distribute the current for the heaters, fans and unit through three separate outlets and cables, if required.

Wiring to the unit should be routed via a double-pole isolating switch (in accordance with local electrical wiring regulations) adjacent to the unit, or taken from the distribution board.

Ensure suspension between power and control cable.

- **Mini & Midi**

To connect the power supply:

1. Ensure the local ac power supply is isolated at the distribution board before connecting the supply cable.
2. Ensure the correct fuse type, or circuit breaker has been fitted to the ac power input supply. A means of disconnection should also be provided in the fixed wiring.
3. To prevent the equipment being accidentally switched on while you are away from it the unit isolator may be locked in position. Pull out the yellow inner section of the isolator switch to lock the isolator in position, revealing a hole through which a padlock, or other lockable device, may be inserted.
4. Remove the unit Control Panel cover by unscrewing the six securing screws.

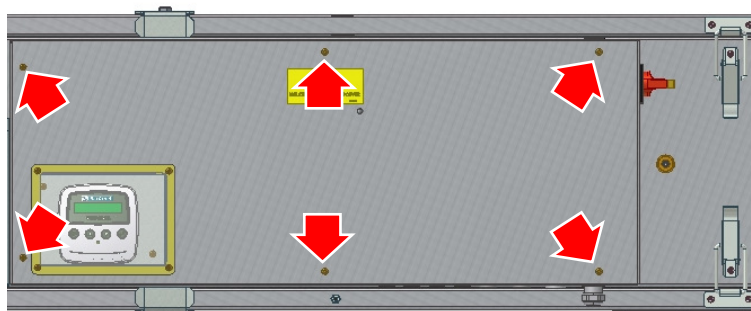

Figure 11: Control Panel Cover Removal

5. Remove the High Voltage Cover by unscrewing the two securing screws.

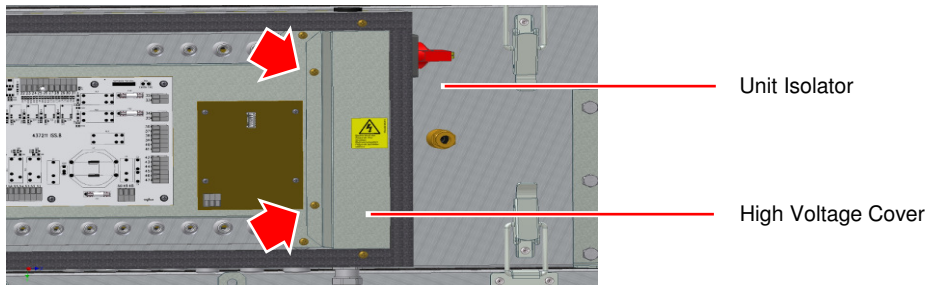

Figure 12: High Voltage Cover Removal

- This high voltage screw terminal block is now uncovered to enable you to connect the ac power cable(s).

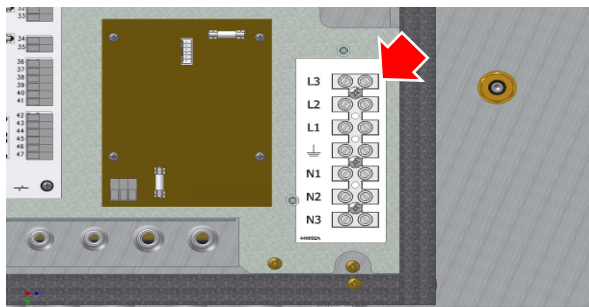

Figure 13: High Voltage Terminal Block

In countries where the required supply current is not available from a single phase supply, the heaters can be wired up to separate single phase supplies which are to be connected according to local regulations.

### Using One Single-Phase Power Supply

- Route a suitably rated round power cable through the cable gland provided on the bottom of the Control Panel directly below the High Voltage Terminal Block. A 7-10 mm diameter cable should be used to ensure sufficient grip by the cable gland. The gland **MUST** be sealed properly to maintain the IP rating of the unit.
- Connect the Earth (green and yellow) wire to the Earth terminal  $\oplus$ , make sure the Earth wire is at least 50mm longer the others. Connect the Live (brown) wire to all three terminals L1, L2 and L3. Connect the Neutral (blue) wire to terminals N1, N2 and N3, as shown in the figure below (wire colours apply to UK cables). If the heaters are not required then omit the links to L2, L3, and N2, N3.

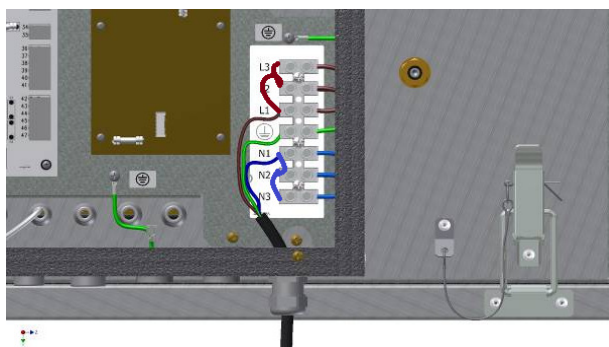

Figure 14: Single-phase Terminal Connections

- Connect the other end of the power cable to a power supply outlet or distribution board.  
**When replacing the cover ensure the earth bonding lead is attached to the cover.**

**Using Three Single-Phase Power Supplies (Remove the links to L2, L3 and N2, N3)**

10. Route three suitably rated round power cables through separate cable glands on the bottom of the Control Panel (additional holes are provided for routing of power and sensor cables, as required). A 7-10 mm diameter cable should be used to ensure sufficient grip by the cable gland. The gland **MUST** be sealed properly to maintain the IP rating of the unit.
11. Connect the three Earth (green and yellow) wires (one from each cable) to the Earth terminal  $\oplus$ . Make sure the Earth wires are at least 50mm longer the others. Connect the Live (brown) wires from each cable to a separate terminal L1, L2 or L3. Connect the Neutral (blue) wire to terminals N1, N2 or N3 (ENSURE THAT WIRES FROM THE SAME CABLE ARE CONNECTED TO THE SAME NUMBERED TERMINAL, I.E. CONNECT CABLE 1 TO TERMINALS L1 AND N1. DO NOT CROSS THE LIVE AND NEUTRAL SUPPLIES), as shown in the diagram below (wire colours apply to UK cables).

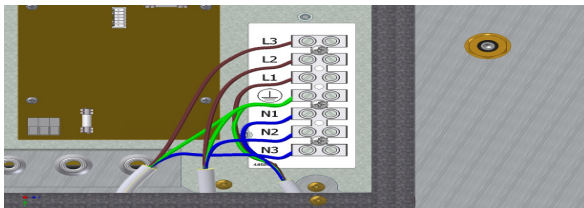

Figure 15: 3x Single-phase Terminal Connections

12. Connect the other ends of the three power cables to three separate power supply outlets or distribution board terminals.
  - **Maxi**
  - Ensure the local ac power supply is isolated before connecting the supply cable.
  - Ensure the correct fuse type, or circuit breaker has been fitted to the ac power input supply. A means of disconnection should also be provided in the fixed wiring.
  - Connect a suitable round power cable through the cable gland provided. A 7-10 mm diameter cable should be used to ensure sufficient grip by the cable gland. The gland **MUST** be sealed properly to maintain the IP rating of the unit. Open the controls hinged door and feed the cable through the unit to the Main Controller PCB located in the controls enclosure. It may be necessary to remove the gland plate in order to feed the cable through - unscrew the six fixing screws securing the gland plate to the chassis.
  - Connect the L/N/E supply to the terminals as identified on the DIN rail, see figure below.

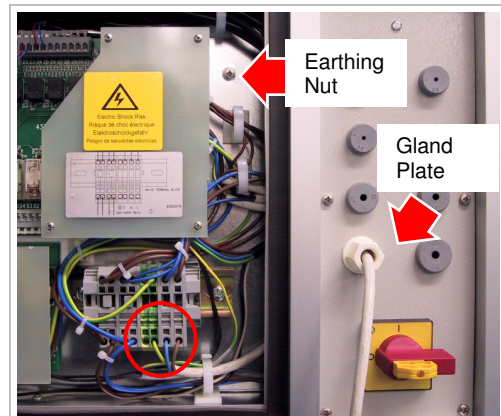
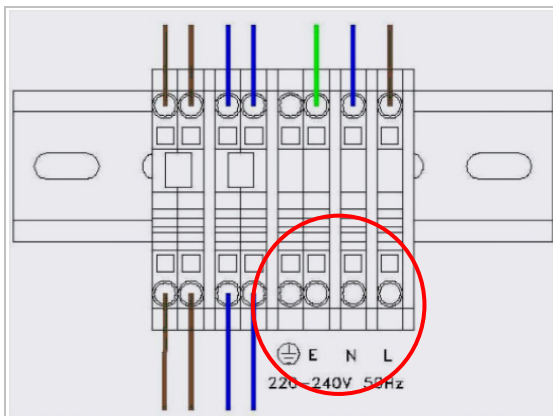

Figure 16: Power Supply Connections

- Connect the other end of the cable to the main power supply outlet.
- Ensure the unit remains isolated until all external connections are made.

## Connect the Commissioning Interface

The Commissioning Interface must be mounted indoors or inside the control enclosure.

Ensure the Commissioning Interface is accessible for commissioning and maintenance. It is recommended that it be mounted near to the main supply isolator, if not inside the control enclosure, since the unit must be switched off and on to access the commissioning screen.

To connect the Commissioning Interface:

1. Open the Commissioning Interface casing to gain access to the interior by inserting a small flat-bladed screwdriver in the slot at the base of the case. Then separate the front and rear halves at the top.

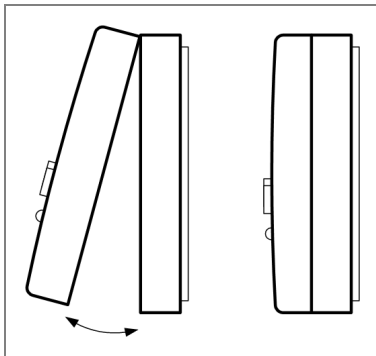

Figure17: Opening the Commissioning Interface

2. Mark and drill the holes for the two fixing screws supplied with the mounting kit. Fix the wall plugs and screws to the wall, leaving the screw heads sufficiently proud of the wall to enable the Commissioning Interface to be attached by lining up the holes in the rear of the casing with the screws and resting the case on the screws.
3. Use 4-core 0.5 mm<sup>2</sup> DEF STAN 61-12 Part 5 Type A cable, or equivalent, to connect the Commissioning Interface to the Main Controller PCB. The diameter of the cable used must not exceed 4 mm in order to pass through the opening of the Commissioning Interface's plastic housing. **The length of the cable should not exceed 10 m.** Screened cable is recommended, with screen connected to the chassis. Unscreened cable may be used if there is no threat from external electrical interference.

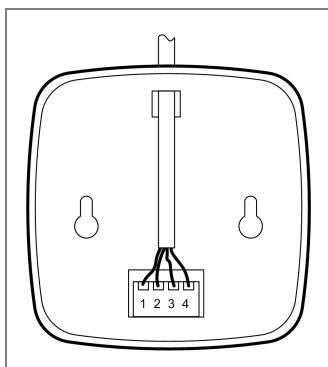

Figure18: Commissioning Interface Connections

4. Connect pins 1-4 on the Commissioning Interface terminal block to the corresponding pins 1-4 on the Main Controller PCB, see *Figure 10: Main Controller PCB Terminal Connections*, i.e. connect Commissioning Interface pins 1 to 87, 2 to 86, 3 to 85 and 4 to 84.
5. Re-assemble the front and rear halves of the Commissioning Interface Casing by first re-engaging the two lugs and slots along the top. Then, press together the bottom edges of the two halves, which should close with an audible click.

## Switching On/Off

### Switch On

The following procedure assumes that all necessary installation actions have been performed in accordance with the instructions given in this section of the manual.

To switch the unit on:

1. Ensure that all top and bottom covers are fitted and properly secured (see *Cover Removal/Replacement* on page 47).
2. Switch on the power at the mains outlet feeding the Sentinel unit.
3. At the unit's cable entry panel, turn the isolator switch to position 1 (ON).
4. Observe the Commissioning Interface. Following switch-on, the Commissioning Interface displays a start-up screen. The start-up screen displays software version number.

**Vent-Axia  
Sentinel HR V\*\*\***

5. Ensure that the Status LED on the Commissioning Interface is green, indicating that the unit is operating normally. The unit will commence operation according to the stored parameters.
6. If commissioning is required, or if the parameters are to be altered, see the following *Commissioning* section on page 24.

### Switching Off

To switch the unit off:

1. At the unit's cable entry panel, turn the isolator switch to position 0 (OFF).
2. If you are intending to carry out work or maintenance inside the unit, switch off the power at the mains outlet supplying the unit before you remove the covers.
3. To prevent the equipment being accidentally switched on while you are away from it the unit isolator may be locked in position. Pull out the yellow inner section of the isolator switch to lock the isolator in position, revealing a hole through which a padlock, or other lockable device, may be inserted.

#### Note

All commissioning settings are permanently stored in non-volatile memory and, therefore, retained in the event of a shutdown or power failure.

## Commissioning

### Commissioning Your Energy Recovery Ventilation System

The instructions in this section are intended to provide configuration and operation information for setting up the equipment. In the event of problems, see *Troubleshooting*.

#### Commissioning Interface

As delivered the Commissioning Interface is fitted to the unit in a weatherproof enclosure. Alternatively it can be relocated to an internal position within 10 m. The Commissioning Interface provides the user interface for commissioning and monitoring purposes.

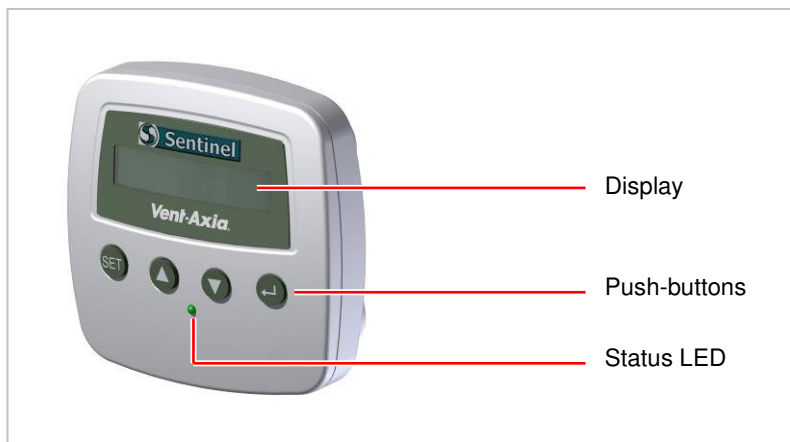
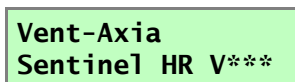

Figure 19: Commissioning Interface

#### Display

The main display is a 16 character, 2-line liquid crystal display (LCD) with automatic backlight, which is turned off to minimise power consumption when the unit is operational (see *Commissioning Screens on page 26*).



#### Push-buttons

Four push-buttons on the Commissioning Interface provide the controls for configuring and monitoring the unit.

Table 2: Commissioning Interface Push-buttons

Push-button	Function
SET (Set)	Press to adjust settings and move to next menu item.
▲ (Up)	Press to go to the above screen or to increase a parameter value. Press and hold for fast response.
▼ (Down)	Press to go to the next screen or to decrease a parameter value. Press and hold for fast response.
↵ (Enter)	Press to enter or move to next menu item.

#### Status LED

A 3-way, multi-colour LED on the Commissioning Interface displays the status of the unit. A similar LED is provided on the side of the unit to provide a local indication of the unit status in the event that the Commissioning Interface is located remotely.



Table 3: Commissioning Interface Status LED

LED Colour	Function
Green	The unit is healthy and operating normally.
Red/Green Flashing	The unit requires the filters to be changed. The unit will continue to operate normally. <i>See Fault LED/Status Relay on page 59.</i>
Red Flashing	The unit has a fault that should be investigated immediately. Operation of the unit is stopped. <i>See Fault LED/Status Relay on page 59.</i>

## How to Commission Your Energy Recovery Ventilation System

The factory default operating mode will be either Constant Pressure or MIN-MAX and always on.

To commission your Energy Recovery Ventilation System,

1. Ensure the unit is switched on, the start-up screen has been displayed and that the Operating and Monitoring Screens (Running Display) are displayed on the Commissioning Interface.
2. Press and hold the  (Enter) push-button for 5 seconds to access the Commissioning Screens.

### Note

All commissioning settings are permanently stored in non-volatile memory and, therefore, retained in the event of a shutdown or power failure.

## Commissioning Screens

When the unit is switched on (see *Switching On* on page 23), the following Commissioning Interface screens are available for monitoring and configuring the unit (default values shown where applicable).

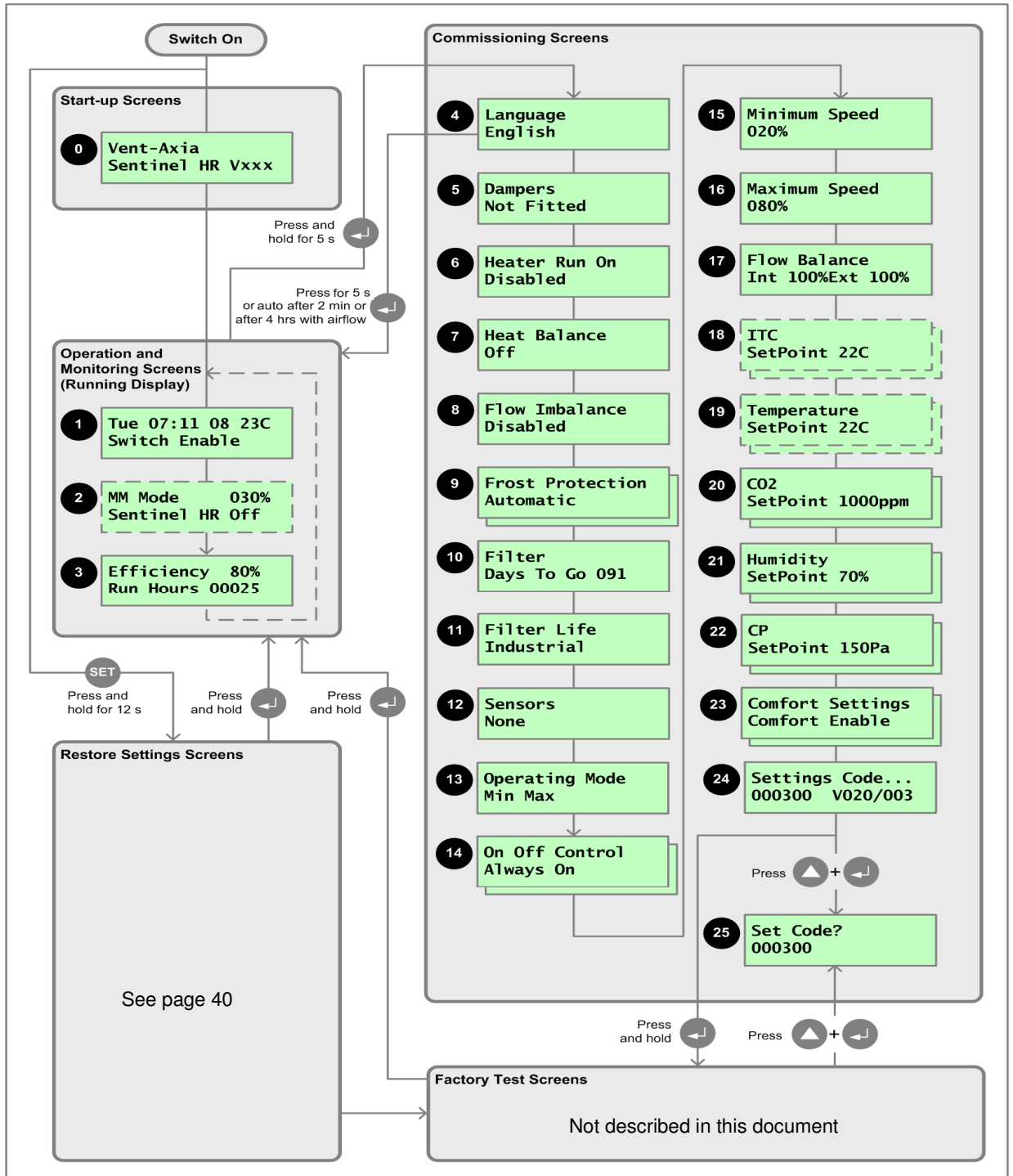



Figure 20: Commissioning Interface – Commissioning Screens

## Commissioning Screens

The commissioning screens are available when the  (Enter) push-button is pressed and held for 5 seconds when the Running Display is shown. These screens enable the unit to be configured to suit the installation requirements of the customer.



**IMPORTANT NOTE: the unit runs for 10 minutes before taking any temperature reading to allow the flows and temperatures to settle. This can cause “problems” when commissioning if not taken into account.**



### 4 Language Screen

The Language screen displays the language option that is set for the software.



Language  
English

Press  (Set) and then use the  (Up) and  (Down) push-buttons to change the language setting.



Press  (Set) again to enter the new setting and use the  (Up) to move down to the next screen.



### 5 Dampers Screen

Powered Back draft dampers may be fitted that close when the unit goes to standby to prevent draughts. The Dampers screen displays whether dampers are wired directly to the unit (to terminals 26-31). This option is NOT accessible in Constant Pressure mode (**Fitted** is changed to **Not Fitted** if Constant Pressure mode is later selected).



Dampers  
Not Fitted

Press  (Set) and then use the  (Up) and  (Down) push-buttons to select one of the two available options (**Fitted** or **Not Fitted**). Default value shown.



Press  (Set) again to enter the new setting and use the  (Up) to move down to the next screen.

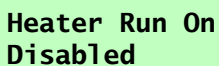

### 6 Heater Run On Screen

The Heater Run On screen enables a time to be set for the fan motors to keep running when an external duct heater, if fitted, is turned off to allow cooling airflow to dissipate the heat.



Heater Run On  
Disabled

Press  (Set) and then use the  (Up) and  (Down) push-buttons to select one of the two available options (**Enabled** or **Disabled**). Default value shown.

If **Enabled** is selected, press  (Set) again and then use the  (Up) and  (Down) push-buttons to adjust the time setting in seconds (**30 - 180**).

Press  (Set) again to enter the new setting and move down to the next screen.

## 7 Heat Balance Screen

The Heat Balance Screen allows the anti-frost heaters to be used to top up the temperature of the supply air to the room. The heat exchanger is between 80% and 95% efficient depending on the model and flow rate. Thus if the ambient is 10C and the room is 20C the incoming air should be about 18 – 19C. In certain applications it may be required to increase this temperature. The default is OFF. This setting allows you to switch this control to BALANCE the supply temperature to the extract temperature of the room or to set a specific supply air temperature between 10C and 30C as a target for the supply temperature.

The Totus is not able to cool the air; the heating is done by electric coils fitted to the unit and this may not be the preferred method of heating by the operator of the building.

If the anti-frost logic is triggered then it will take priority over this control in order to prevent freezing of the heat exchanger.

**Heat Balance  
Off**

Press **SET** (Set) and then use the **▲** (Up) and **▼** (Down) push-buttons to select the available options (**Off** or **10C to 30C**). Default value shown.

Press **SET** (Set) again to enter the new setting and move down to the next screen.

## 8 Flow Imbalance (for Frost Protection) Screen

The Flow Imbalance screen enables a proportional change of supply and extract in Frost Protection mode and comfort settings.

### Note:

For setting an imbalanced airflow for other reasons, see *Flow Balance Screen on page 32*.

**Flow Imbalance  
Disabled**

Press **SET** (Set) and then use the **▲** (Up) and **▼** (Down) push-buttons to select one of the available options (**Enabled** or **Disabled**). Default value shown.

Press **SET** (Set) again to enter the new setting and move down to the next screen.

## 9 Frost Protection Screen

The Frost Protection screen displays options for the protection of the unit against frost. Protection measures may be factory set, in which case no selectable options will be available.

**Frost Protection  
Automatic**

Frost protection is set to **Automatic** if heaters are fitted to the unit, otherwise **Flow Imbalance** is used, if enabled. If neither of the previous two options are enabled **Bypass Mode** is used.

- **Automatic** - the default setting, if air intake heaters are fitted. In this mode when the incoming air is less than -1C and the air being discharged to atmosphere is less than 3C the first heater starts. Every 10 mins the temperatures are checked, if the air into the heat recovery cell is still less than -1C then the second heater is started. The heaters are sized so that the unit will operate down to -7C at full air flow before frost is likely to start. The air flows will continue operating at the settings called for by the control system.

**Note:**

The temperatures of Int -1C measured at the unit intake from ambient and Ext 03C measured at the unit discharge to ambient have been established after extensive laboratory tests and have been shown to prevent the heat recovery cell from freezing. **It is strongly recommended that these default figures are used.** The consequences of the heat exchanger freezing usually includes a severe water leak when it eventually defrosts and consequential damage to the property.

- **Flow Imbalance** - in this mode the heaters are not used. If Flow Imbalance has been enabled then at the same trigger temperatures as above, the extract fan begins to speed up until it maintains the -1C temperature. If this is not achieved when it reaches the boost speed then the supply fan begins to slow.
- **Bypass Mode** - if Flow Imbalance has not been enabled then, when the trigger temperature are reached, the bypass opens and the flow goes to minimum speed. An error message is displayed. See *Status Display* on page 42.

**Note:**

The temperature that triggers the operation of the anti-frost features is adjustable.

Press **SET** (Set) and then use the **▲** (Up) and **▼** (Down) push-buttons to select the internal and external trigger temperatures.

**Frost Protection**  
Int -1C Ext 03C

## 10 Filter Screen

The Filter screen displays the days to go before replacement of the fan filters is necessary. The number of days runs down from the value selected in the Filter Life screen (see below). There are no selectable options on this screen.

**Filter**  
Days To Go 091

When the time runs down to **000**, a fan filter alarm will be displayed, the filters must be replaced and the screen displays **Replaced/No/Yes**. Use the **▲** (Up) and **▼** (Down) push-buttons to select **Yes** and reset the timer.

Press **SET** (Set) to move down to the next screen.

## 11 Filter Life Screen

The Filter Life screen displays the days to go before replacement of the fan filters is necessary. The number of days is set depending on the environment in which the unit will be used.

**Filter Life**  
Industrial

Press **SET** (Set) and then use the **▲** (Up) and **▼** (Down) push-buttons to select the type of filter fitted (**Industrial** (091), **Urban** (182) or **Rural** (365)).

Press **SET** (Set) again to enter the new setting and move down to the next screen.

## 12 Sensors Screen

The Sensors screen detects for any proportional environmental sensors connected to the unit when the unit is first switched on. This happens automatically when the Control Board is new or has been restored to 'uncommissioned'. The screen may display one of the following options **Checking/None**, **Constant Pressure**, **Proportional**, **BMS** alternating with **Update?**, depending on the sensor(s) detected.

**Sensors**  
**None**

The priority is as follows:

- If a pressure sensor has been factory fitted, then Constant Pressure mode is implemented.
- If a CO2 sensor has been factory fitted, then Proportional mode is assumed and the unit will 'look' for other sensors. If sensor(s) found then Proportional mode is implemented.
- If a BMS 0 -10 V input is found then BMS mode is implemented.
- If a BMS enable input found (closed) then BMS mode is implemented.
- Otherwise, if none of the above conditions are detected, the default Min Max mode is implemented.

If the installation wiring is incomplete at commissioning time, then either fit resistors between +24V and the required sensor inputs or re-do the setup later as described below.

When the operating mode has been set, the display shows the appropriate sensor output(s). The operating mode can be changed manually and this will be the way in which the Totus will run (e.g. Constant Pressure might be ignored and Comfort Setting selected).

The set-up can be re-done by pressing **SET** (Set) while **Update?** is displayed on the **Sensors** display.

Min Max can be set to Proportional or BMS.

Proportional can have different sensors or go to BMS or to Min Max when no sensors are found.

If the operating mode has been set to BMS, Constant Pressure or Comfort Setting, then set it to Proportional or Min Max to access the set-up. Remember to set it back on completion.

Press **SET** (Set) to move down to the next screen.

## 13 Operating Mode Screen

The Operating Mode screen displays the mode of the unit when running in normal operation. This may be enabled automatically by the detection of relevant sensors, or may be manually adjusted. Note that some options on other screens may be affected by the choice of operating mode.

**Operating Mode**  
**Min Max**

Press **SET** (Set) and then use the **▲** (Up) and **▼** (Down) push-buttons to select one of the available options (**Min Max**, **BMS**, **Proportional**, **Constant Pressure** or **ITC**).

- **Min Max** – a manually selectable option. In this mode, the unit responds to switch inputs (time, thermostat, PIR, humidistat or AQS switch). The switch input causes the fan speed to change from the minimum (trickle) to the maximum (boost) speed.
- **BMS** – a manually selectable option. In this mode, an external Building Management System is used to proportionally control the unit fan speed. When this mode is selected, the On Off Control mode is automatically set to BMS Enable.



- **Proportional** – a manually selectable option. In this mode, the unit fan speed responds proportionately to either the CO<sub>2</sub>, temperature, humidity sensor proportional inputs or the remote / local inputs.
- **Constant Pressure** – entered automatically if a pressure sensor is detected on start-up. In this mode, the fan speed responds to maintain a constant fan inlet negative pressure as a result of downstream duct resistance variations. A pressure sensor with a 0-10 V proportional input is used to drive the fan speed.
- **ITC** – a manually selectable option. In this Internal Temperature Control mode, the exhaust air temperature (T4) is compared against a user-settable room temperature.





Press  (Set) to move down to the next screen.

## 14 On Off Control Screen

The On Off Control screen displays the method by which the unit is taken out of standby mode.

**On Off Control**  
**Always On**

Press  (Set) and then use the  (Up) and  (Down) push-buttons to select one of the available options (**Always On**, **Switch Enable**, **BMS Enable**, **Internal Clock** or **Internal Clock +**). Default value shown.

- **Always On** – the unit is always operational and does not run on standby (typically used in environments that are occupied 24 hours a day, such as hospitals).
- **BMS Enable** – the unit may be turned on by a Building Management System (typically a computer-controlled relay). This may be configured as a time controller or use other switches or sensors to control the turn on of the unit. When **BMS** is selected as the Operating Mode, **BMS Enable** is automatically selected as the On Off Control and no further options are selectable.
- **Switch Enable** – the unit may be turned on by means of a physical switch (typically a wall switch in the room). When not turned on, the unit will be in standby mode.
- **Internal Clock** – the unit may be turned on according to a timer that may be set by additional screens. Press  (Set) and then use the  (Up) and  (Down) push-buttons to select an on and off time for each day of the week. Minimum run or stop time is 10 mins. If set closer than this '!' is displayed and the switch action (on to off or off to on) is ignored. No other device may change the speed when the unit is off because of this clock setting.
- **Internal Clock+** – Closing **Switch 1** (see *Figure 10* on page 18 ) input with **Internal Clock +** overrides the time clock (as does pressing the  (Enter) push-button when **Day Time** is displayed).

**Day On Off**  
**Mon 07:00 18:00**



To finish, press the  (Enter) push-button when day flashes or after setting the last off time for Sunday.

Press  (Set) to move down to the next screen.

## 15 Minimum Speed Screen

When in **Min Max** mode, the Minimum Speed screen enables the minimum speed for the fan motors to be set.

**Minimum Speed**  
**020%**

Press  (Set) and then use the  (Up) and  (Down) push-buttons to select a percentage (**0%** to (maximum speed -**5%**)). The minimum that may be set is 1%, if **Heater Run On** is enabled.

Press  (Set) again to enter the new setting and move down to the next screen.

## 16 Maximum Speed Screen

When in **Min Max** mode, the Maximum Speed screen enables the maximum speed for the fan motors to be set.

**Maximum Speed**  
**080%**

Press **SET** (Set) and then use the **▲** (Up) and **▼** (Down) push-buttons to select a percentage (Minimum **+5%** to **100%**).

Press **SET** (Set) again to enter the new setting and move down to the next screen.

## 17 Flow Balance Screen

The Flow Balance screen enables the balance between intake and extract motor speed to be adjusted. An imbalance may be set between the supply and extract airflow, if required. The motors are allowed to run at different speeds, enabling a room to be kept at positive or negative pressure. Note that 100% referred to here is 100% of the set speed. The adjustment available is from 80% to 100% of that set speed.

**Flow Balance**  
**Int 100%Ext 100%**

Press **SET** (Set) and then use the **▲** (Up) and **▼** (Down) push-buttons to set the **Intake** percentage (**80** to **100%**).

Press **SET** (Set) and then use the **▲** (Up) and **▼** (Down) push-buttons to set the **Extract** percentage (**80** to **100%**). 100% reduced in proportion when motor maximum reached.

Press **SET** (Set) again to enter the new setting and move down to the next screen.

## 18 ITC Parameters Screen

This ITC Parameters screen is only displayed if Internal Temperature Control (ITC) mode is selected at the Operating Mode screen (see *Operating Mode Screen on page 30*). The ITC screen enables the Internal Temperature Control mode settings, measure by an internal temperature sensor, to be adjusted.

**ITC**  
**SetPoint 22C**

Press **SET** (Set) and then use the **▲** (Up) and **▼** (Down) push-buttons to adjust the temperature (in degrees C) for the ITC SetPoint (**10** to **35**). This is the target room temperature.

Press **SET** (Set) again to enter the new setting and move down to the next screen.

**ITC**  
**Passband 10C**

Press **SET** (Set) and then use the **▲** (Up) and **▼** (Down) push-buttons to adjust the temperature (in degrees C) for the ITC Passband (**02** to **50**). This is the range of temperatures that proportionally control the motor speed from minimum to maximum.

This concept applies to the CO<sub>2</sub> and humidity proportional control too.



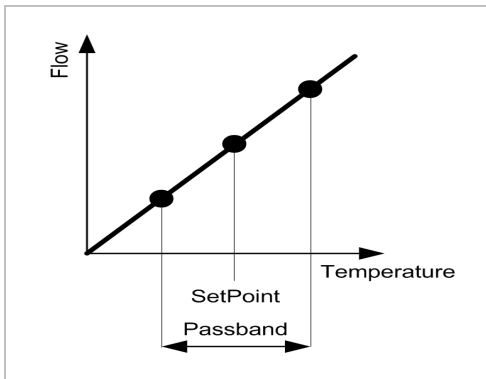

Press **SET** (Set) again to enter the new setting and move down to the next screen.

## 19 Temperature Parameters Screen

This Temperature Parameters screen is only displayed if relevant sensors are detected at the **Sensors** screen (see *Sensors Screen on page 30*). This screen enables the temperature settings for Setpoint and Passband, measured by an external sensor, to be adjusted.

**Temperature  
SetPoint 22C**

Press **SET** (Set) and then use the **▲** (Up) and **▼** (Down) push-buttons to adjust the temperature (in degrees C) for the Temperature SetPoint (**10 to 35**). This is the target room temperature.

Press **SET** (Set) again to enter the new setting and move down to the next screen.

**Temperature  
Passband 10C**

Press **SET** (Set) and then use the **▲** (Up) and **▼** (Down) push-buttons to adjust the temperature (in degrees C) for the Temperature Passband (**02 to 50**). This is the range of temperatures that proportionally control the motor speed from minimum to maximum.

Press **SET** (Set) again to enter the new setting and move down to the next screen.

## 20 CO2 Parameters Screen

This CO2 Parameters screen is only displayed if relevant sensors are detected at the **Sensors** screen (see *Sensors Screen on page 30*). This screen enables the carbon dioxide settings for Setpoint and Passband to be adjusted.

**CO2  
SetPoint 1000ppm**

Press **SET** (Set) and then use the **▲** (Up) and **▼** (Down) push-buttons to adjust the CO2 SetPoint (**200 to 2000ppm**). This is the target CO2 level.

Press **SET** (Set) again to enter the new settings and move down to the next screen.

**CO2  
Passband 1000ppm**



Press **SET** (Set) and then use the **▲** (Up) and **▼** (Down) push-buttons to adjust the CO2 Passband (**200 to 2000ppm**). This is the range of CO2 that proportionally control the motor speed from minimum to maximum.

Press  (Set) again to enter the new setting and move down to the next screen.

## 21 Humidity Parameters Screen



This Humidity Parameters screen is only displayed if relevant sensors are detected at the **Sensors** screen (*Sensors Screen on page 30*). This screen enables the humidity settings for Setpoint and Passband to be adjusted.

**Humidity  
SetPoint 70%**

Press  (Set) and then use the  (Up) and  (Down) push-buttons to adjust the Humidity SetPoint (**25 to 90%**). This is the target Humidity level.

Press  (Set) again to enter the new settings and move down to the next screen.

**Humidity  
Passband 40%**

Press  (Set) and then use the  (Up) and  (Down) push-buttons to adjust the Humidity Passband (**2 to 100%**). This is the range of Humidity that proportionally control the motor speed from minimum to maximum.

Press  (Set) again to enter the new setting and move down to the next screen.

## 22 Constant Pressure Parameters Screen



This Constant Pressure Parameters screen is only displayed if relevant sensors are detected at the **Sensors** screen (*Sensors Screen on page 30*). This screen enables the Constant Pressure settings for Setpoint and PID Sensitivity to be adjusted.

**CP  
SetPoint 150Pa**

Press  (Set) and then use the  (Up) and  (Down) push-buttons to adjust the Constant Pressure SetPoint (**50 to 490Pa**). This is the target pressure.

Press  (Set) again to enter the new settings and move down to the next screen.

**CP  
PID Medium**

Press  (Set) and then use the  (Up) and  (Down) push-buttons to select the Constant Pressure PID Sensitivity (**Low, Medium or High**). This is the range of pressure that proportionally control the motor speed from minimum to maximum.

Press  (Set) again to enter the new setting and move down to the next screen.

## 23 Comfort Settings Screen

The Comfort Settings screen enables comfort, bypass and overheat settings to be adjusted.

- **Comfort** – cools the room by either varying the fan speed, or by opening the bypass when a threshold temperature is reached.
- **Bypass** – cools the room by opening the bypass when a threshold temperature is reached.
- **Overheat** – cools the room when triggered by a high extract air (T3) at 3 pm, then runs at night when intake air (T1) is cool. This requires switch input 4 (central heating) to be connected.

## Comfort Settings - Comfort

### Note

Comfort control is not available with ITC mode or Proportional with external temperature sensor because they both deal with a warm room by running the fans faster.

### Comfort Settings

.....

Press **SET** (Set) and then use the **▲** (Up) and **▼** (Down) push-buttons to select the **Comfort Enable/Disable** option.

### Comfort Settings Comfort Enable

If **Comfort Enable** is selected, pressing **SET** (Set) again enables you to select a temperature (in degrees C) for the comfort setting (**20C to 29C**). This is the target room temperature. The fans speed up above this set temperature to increase the airflow.

### Comfort Settings Comfort 24C

Press **SET** (Set) again to enter the new setting and move down to the next screen.

## Comfort Settings - Bypass

Models fitted with a Summer Bypass will provide energy-free heating and energy-free cooling when the house temperature and ambient temperature allows.

If the room is warmer than the set (shown as "**indoor**") temperature (i.e. you need the room to be cooler) and the outdoor air is cooler than the actual room temperature (i.e. the outdoor air could cool your room) then the bypass will open and the unit will supply cooler air to your room.

If the room is cooler than the set ("**indoor**") temperature (i.e. you need the room heating) and the outdoor air is warmer than the actual room temperature (i.e. the outdoor air could heat your room) then the bypass will open and the unit will supply warmer air to your room.

### Note

The above only applies whilst the outdoor air temperature is above 14 C (adjustable) in order to prevent cold draughts.

The set ("**indoor**") temperature should be set 2 or 3 degrees higher than the central heating thermostat and 2 or 3 degrees below any air conditioning thermostat, if fitted. This will prevent any clash between the separate systems.

Use the **▲** (Up) and **▼** (Down) push-buttons to select the **Bypass Enable/Disable** option. This enables or disables the Summer Bypass.

### Comfort Settings Bypass Enable

If **Bypass Enable** is selected, pressing **SET** (Set) again enables you to select a temperature (in degrees C) to initiate the bypass (**10 to 30**) using the **Up** and **Down** push-buttons. This is the target room (internal) temperature.

### Comfort Settings Bypass Int 21C

Pressing **SET** (Set) again enables you to select a temperature (in degrees C) to initiate the bypass (**5 to 20**) using the **Up** and **Down** push-buttons. This is the external ambient temperature.

**Comfort Settings**  
**Bypass Ext 15C**

Press **SET** (Set) again to enter the new settings and move down to the next screen.

### **Comfort Settings - Overheat**

Use the **▲** (Up) and **▼** (Down) push-buttons to select the **Overheat Enable/Disable** option.

This allows an overnight purge to happen when a trigger point is reached at 3 pm and the ambient air is cooler than the room air at the following 2 am. The unit brings in the cool air via the summer bypass until the room temperature gets down to the target temperature.

#### **Notes**

- 1 The unit must be in a standby mode from the use of the time clock, BMS or switched input.
- 2 Switched input 4 (central heating) must be connected.

**Comfort Settings**  
**Overheat Enable**

If **Overheat Enable** is selected, pressing **SET** (Set) again enables you to select a temperature (in degrees C) for the summer overheat trigger temperature (**21C to 40C**) using the **Up** and **Down** push-buttons.

**Comfort Settings**  
**Overheat > 30C**

Press **SET** (Set) again to enter the new settings and move down to the next screen. Use the **▲** (Up) and **▼** (Down) push-buttons to select a target temperature (in degrees C) for the summer overheat stop temperature (**10C to 20C**).

**Comfort Settings**  
**Overheat < 20C**

Press **SET** (Set) again to enter the new settings and move down to the next screen.

## **24 Settings Code Screen**

The Settings Code screen displays a six-digit code (**000300**) that represents the commissioning parameters that have been set (see

*The Settings Code on page 38*). It also displays the Main Controller PCB software version number and the Commissioning Interface software version number.





**Settings Code**  
**000300 V\*\*\*/\*\***

This is the last of the Commissioning screens. After 2 minutes of inactivity you will be automatically returned to the Operating and Monitoring Screens (Running Display). Alternatively, navigate to the Language Screen using either the **▲** (Up) or **▼** (Down) push-buttons and then press and hold the **↵** (Enter) push-button for 5 seconds.

Press and hold the **↵** (Enter) push-button to exit the commissioning screens and show **Sentinel HR Test**. Press the **▼** (Down) and **↵** (Enter) push-button simultaneously to display the **Code Set** screen.

## 25 Set Code Screen



The Set Code screen is accessible when either:

- the  (Down) and  (Enter) push-button simultaneously from the **Settings Code** screen, or
- the  (Down) and  (Enter) push-button simultaneously from the **Sentinel HR Test** screen.

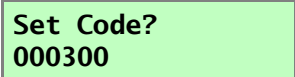
This screen enables the settings code to be changed on a replacement Main Controller PCB, as an alternative to re-entering the settings using the commissioning screens to re-establish the unit configuration, or where multiple units need to be commissioned at the same site with the same settings.



**Set Code?**  
**000300**

Press  (Set) and then use the  (Up) and  (Down) push-buttons to enter each of the 6 appropriate code numbers (see

*The Settings Code on page 38*).

Press  (Set) again to enter the new setting and to go to the Factory Test to calibrate the bypass drive.

## The Settings Code

The settings code is displayed on the last commissioning screen (see *Settings Code Screen on page 36*). The code corresponds to the settings selected on the commissioning screens, as shown below.

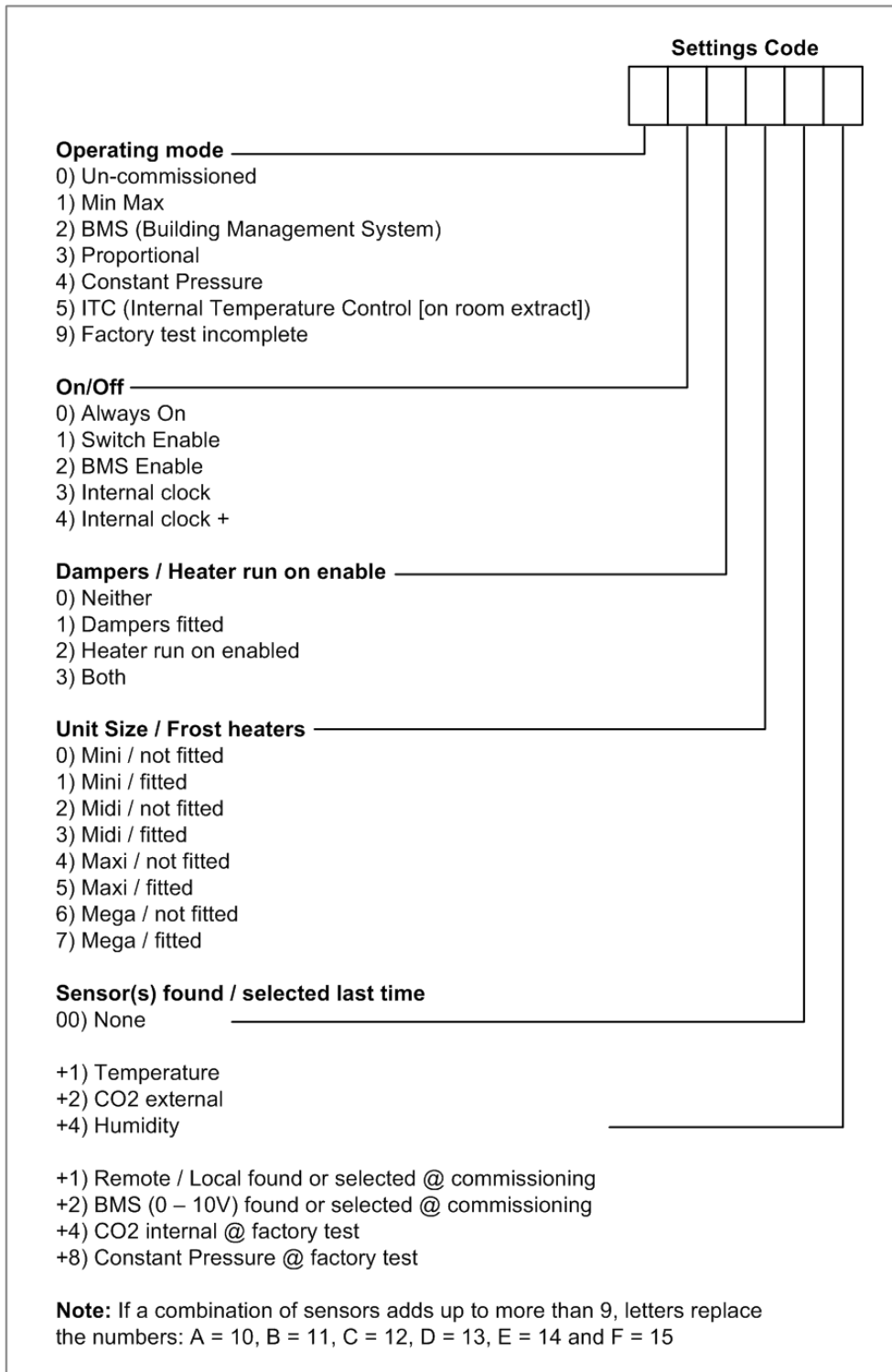

Figure 22: Settings Code

## Writing Down the Settings Code

On completion of commissioning, write down the settings code, corresponding to the chosen settings, on the **Installer Notice** label provided inside the Control Panel and on the *Technical Specification on page 6* of this manual.



Figure 23: Installer Notice Label

The commissioning settings are stored in non-volatile memory on the Main Controller PCB and will be automatically restored after a shutdown or power outage. The internal clock is maintained during a power failure by a battery on the Main Controller PCB. If this system fails for any reason, the configuration code written on the back of the door may be used to reinstate the settings.

Using the settings code is a quick way to restore the settings of a unit. It is also a quick way to configure multiple units in a large installation if they are all required to operate in the same way.

**Note:**

The settings code WILL NOT restore **time settings** or **comfort settings**, which will be set to the default settings. These must, therefore, be set manually on each unit using the commissioning screens provided by the Commissioning Interface.

## Default Settings

The following default commissioning settings are present when the unit is switched on.

Table 4: Default Settings

Parameters	Settings
Set Clock	-
Dampers	Not fitted
Heater Run On	Disabled
Flow Imbalance	Enabled
Frost Protection	Auto, if heaters fitted
Filter	91 days
Sensors	-
Operating Mode	-
On Off Control	Always On (if Internal Clock selected default on off = 6:30 – 22:30)
Minimum Speed	20%
Maximum Speed	80%
Flow Balance	Int 100% , Ext 100%
ITC	-
Comfort Settings	Comfort Enable (24C), Bypass Enable (21C), Ext Temperature (15C), Overheat Enable (summer overheat trigger 30C and summer overheat stop 20C)
Settings Code	-

## Restoring Factory Settings

### Restore Settings Screens

Switch on the unit while holding the **SET** (Set) push-button (for approximately 12 seconds) to display the **Restore Settings** screens (default values shown where applicable).

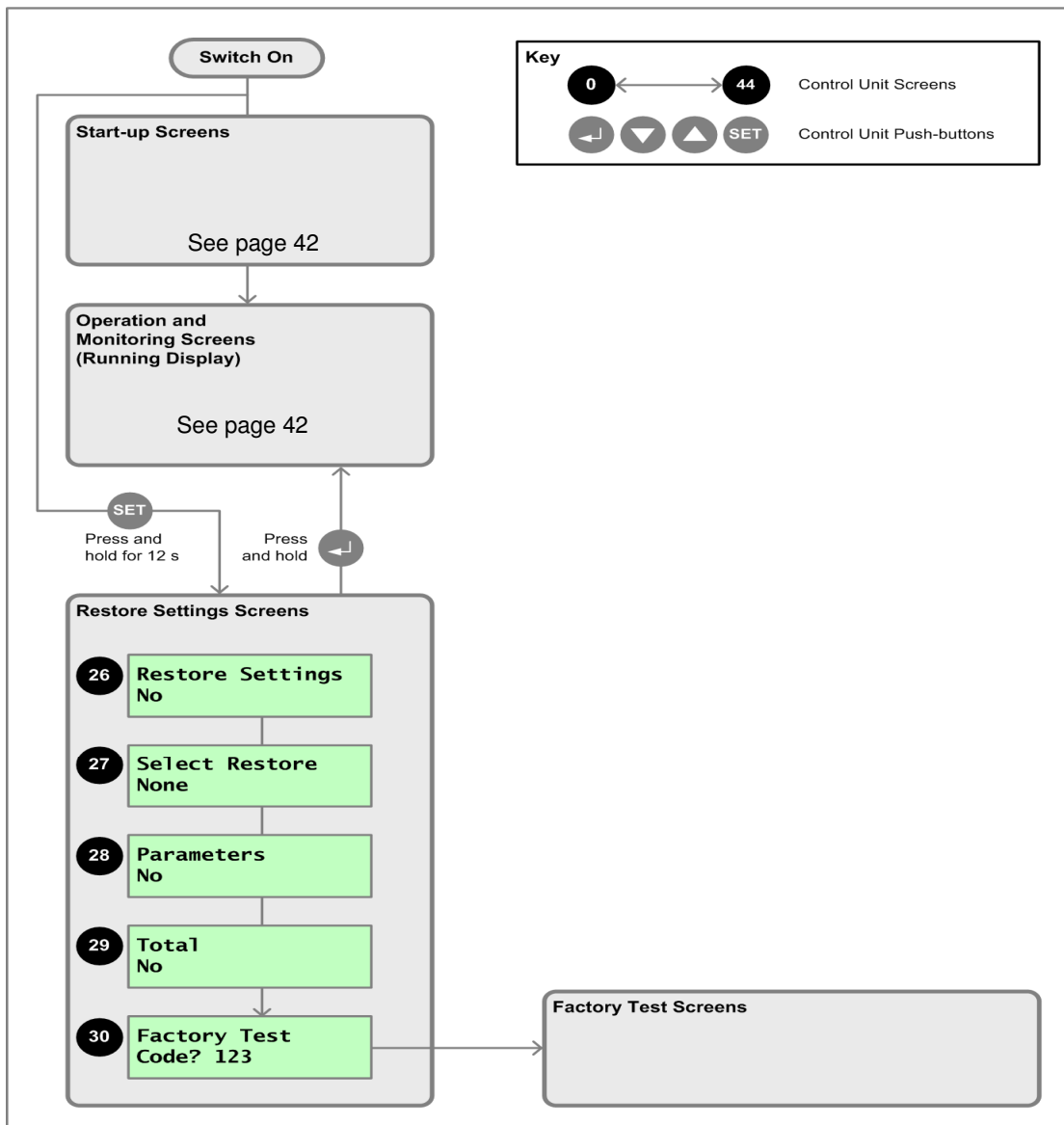

Figure 24: Commissioning Interface - Restore Screens

### 26 Restore Settings Screen

To restore settings to the factory defaults, switch on the unit while holding the **SET** (Set) push-button until the **Restore Settings** screen is displayed (approximately 12 seconds).

To leave the Restore Settings screens at any point with settings unchanged, press the **Enter** push-button.

This Restore Settings screen enables you to enable the restore settings mode.



# Restoring Factory Settings

**Restore Settings**  
**No**

Press **SET** (Set) and then use the **▲** (Up) and **▼** (Down) push-buttons to select/change the option (**No** or **Yes**).  
Press **SET** (Set) again to enter the new setting and move down to the next screen.

## 27 Select Restore Screen

This Select Restore screen enables you to select the type of restore operation to be performed.

**Select Restore**  
**None**

Press **SET** (Set) and then use the **▲** (Up) and **▼** (Down) push-buttons to select from the available options (**None**, **Parameters**, **Total** or **Factory Test**).  
Press **SET** (Set) again to enter the new setting and move down to the next screen.

## 28 Parameters Screen

This Parameters screen enables you to restore key parameters to their default values. This option restores minimum and maximum speeds, flow balance, internal clock on/off times, all sensor set points and pass bands, comfort, bypass and overheat to their default values.

**Parameters**  
**No**

Press **SET** (Set) and then use the **▲** (Up) and **▼** (Down) push-buttons to select/change the option (**No** or **Yes**).  
Press **SET** (Set) again to enter the new setting and move down to the next screen.

## 29 Total Screen

This Total screen enables you to restore additional parameters to their default values and sensors to their factory test state. This option restores dampers, heater run-on, on/off mode, operating mode to 'uncommissioned' and flow imbalance to their default values.

**Total**  
**No**

Press **SET** (Set) and then use the **▲** (Up) and **▼** (Down) push-buttons to select/change the option (**No** or **Yes**).  
Press **SET** (Set) again to enter the new setting and move down to the next screen.

## 30 Factory Test Screen

THIS IS FOR VENT-AXIA TRAINED PERSONNEL ONLY

This Factory Test screen enables you to repeat a factory test on a previously tested Main Controller Board by entering the appropriate code number.

**Factory Test**  
**Code? 123**

Press **SET** (Set) and then use the **▲** (Up) and **▼** (Down) push-buttons to enter the code.  
Press **SET** (Set) again to enter the new setting and proceed with the Factory Test.

## Operation and Monitoring

### About Operation and Monitoring

When the Sentinel Totus 2 unit has been installed and commissioned (see the previous sections) it should require no further intervention in order to operate, unless external switches are used to control on/off/boost, etc, or BMS control requires user action.

When the commissioning screens are exited, the Commissioning Interface display returns to the status monitoring screens, as described below (see also *Figure 20: Commissioning Interface* on page 24).

### Status Monitoring Screens

The Status Monitoring (Running Display) screens display status and key operational conditions (temperatures or pressures, etc.) according to how the unit has been configured. These screens are displayed in a loop during normal operation of the unit, either after displaying the start-up screens, or when commissioning has been completed. After a few seconds the display backlight is turned off in order to minimise power consumption. The **Up** and **Down** push-buttons can be used to stop the loop sequence in order to display individual screens for a longer period with the backlight turned on, if required.

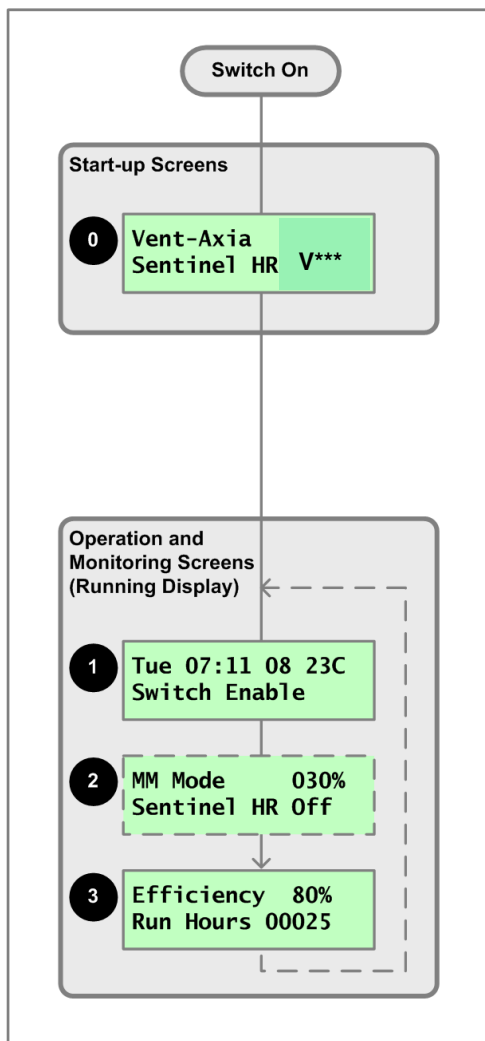
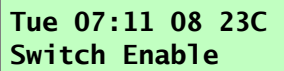

Figure 25: Commissioning Interface – Operation and Monitoring Screens

## 1 Day/Time/Temp/On Off Mode Screen

This screen displays the day, time, temperature and on/off mode information.



Tue 07:11 08 23C  
Switch Enable

The top line displays day, time and temperature information:

- **Day (Tue)** which could be **Sun, Mon, Tue, Wed, Thu, Fri, or Sat**.
- **Time (07:11)** in hours: minutes (24-hour clock).
- **Intake Temperature (08)** measured by thermistor T1, see *Figure 1: Sentinel* on page 4 & 5.
- **Extract Temperature (23C)** measured by thermistor T3, see *Figure 1: Sentinel* on page 4 & 5.

To adjust the clock date and time, press  (Set) when the **Day/Time** is displayed. Adjustment for Daylight Saving is automatic.

The bottom line displays on/off mode control information:

- **Always On**
- **Switch Enable**
- **BMS Enable**
- **Internal Clock (Next On/Next Off)**

When the **Day/Time** screen is displayed and running **Internal Clock** mode, press  (Enter) to advance to the **Next On** or **Next Off** time.

## 2 Mode/Speed/Status Screen

This screen displays the operating mode and speed (top line) and status information (bottom line).

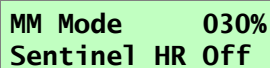

MM Mode 030%  
Sentinel HR Off

The top line displays mode and motor speed information (see *Operating Mode Screen* on page 30), depending on which operating mode is configured.

### **Min/Max Mode**

The following display is shown, when min/max mode is configured.

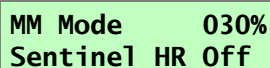

MM Mode 030%  
Sentinel HR Off

The top line shows **MM Mode, Speed %**.

The bottom line displays status information, see *Status Display* on page 44.

### **BMS Mode**

The following display is shown, when BMS mode is configured.

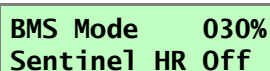

BMS Mode 030%  
Sentinel HR Off

The top line shows either:

- **BMS Mode, Speed %**

- **BMS Signal %**

The bottom line displays status information, see *Status Display*.

### **Proportional Mode**

The following display is shown, when proportional mode is configured.

```
PR Mode    030%  
Sentinel HR Off
```

The top line shows:

- **PR Mode, Speed %** and alternating with the sensor(s) connected
- **Remote Local Signal %**
- **CO2 Internal Signal ppm**
- **Temperature Signal C**
- **CO2 Ext Signal ppm**
- **Humidity Signal %**

The bottom line displays status information, see *Status Display*.

### **Constant Pressure Mode**

The following display is shown, when constant pressure mode is configured.

```
CP Mode    030%  
Sentinel HR Off
```

The top line shows either:

- **CP Mode, Speed %**
- **Set Point, Measured Pressure**

The bottom line displays status information, see *Status Display*.

### **ITC Mode**

The following display is shown, when ITC mode is configured.

```
ITC Mode   030%  
Sentinel HR Off
```

The top line shows either:

- **ITC Mode, Speed %**
- **Set Point, Speed %**

The bottom line displays status information, see *Status Display*.

### **Status Display**

The bottom line of the **Mode/Speed/Status** screen always displays unit status. Any of the following messages may be displayed:

- **Sentinel HR Off**
- **Sentinel HR On**
- **Dampers Opening**
- **Dampers Closing**

- **Bypass Closing**
- **Heater Run On**
- **Bypass Open + code**
  - 0 closing after an open event has finished
  - 1 power on test
  - 2 comfort control
  - 3 summer bypass
  - 4 overheat
  - 5 defrost
- **Bypass Fail**
- **Defrost Mode + code**
  - 1 – 10 imbalance mode speed
  - 50 / 51 heater 1 / heater 2
  - 60 fans at minimum
  - 61 and bypass open
  - 62 3-hour timeout and stop
- **Untested**
- **Uncommissioned**
- **Replace Filter**
- **Heating Fail + countdown** (If the temperature from the room is less than 5C the heating fail is activated the unit stops for 1 Hour and then re samples the temperature in the room)
  - 10 to 0, fans running
  - 60 to 0, fans stopped
- **Overheat Active + code**
  - 0 cancelling
  - 1 triggered @ 3pm
  - 2 running (from 2am)
  - 3 sampling (from 2am)
  - 4 going off
- **Comfort Control**
- **Heat Balance On**
- **Starting....**

### 3 Efficiency Screen

The Efficiency screen displays the following information.

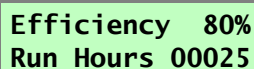

Efficiency 80%  
Run Hours 00025

The top line indicates the efficiency of the heat recovery unit. Initially it displays **80%** at switch on for the first ten minutes to allow the unit time to stabilise, and is updated every 5 seconds to reflect the current heat recovery efficiency of the unit. The screen displays “---” when off or in standby.

The bottom line shows either:

- **Run Hours** – indicates the number of hours that the unit has been operational.
- **Filter Days** – indicates the number of days left before the filters must be changed.

## Maintenance

### Caring for Your Unit

Heat recovery units, by their very nature, require regular maintenance. The Sentinel Totus 2 D-ERV has been designed to facilitate access to enable maintenance to be carried out easily.

In addition to the maintenance tasks outlined below, periodic sterilisation of the unit in line with current medical advice on legionella risks is required. This is contained in a separate leaflet available from Vent-Axia.

### 3-Monthly Maintenance

The following 3-monthly maintenance is recommended:

*Table 5: 3-Monthly Maintenance*

Item	Action
General	Inspect the unit internally for build-up of dust, dirt and condensation. Clean as required.
Filters	The Status LED on the Commissioning Interface, and on the cable inlet panel, will flash red and green alternately when the filters require replacement. This alarm is triggered by the number of days that the unit has been running. Replace the filters. Note the filters are NOT washable. Observe the warning label provided on the filters regarding face mask protection and disposal of the used item. When the filter has been replaced, reset the Status LED by following the instructions on the Commissioning Interface Filter screen. This will reset the timer back to selected days.

### 12-Monthly Maintenance

The following 12-monthly maintenance is recommended:

*Table 6: 5 12-Monthly Maintenance*

Item	Action
Heat Exchanger Cell	Inspect the cell for build-up of dust and dirt. Blow with an airline to clean it. The cell is not designed to be removed for cleaning.
Motors	Inspect the motors for build-up of dust and dirt on the impeller blades, which could cause imbalance and increased noise levels. Vacuum or wipe clean if necessary.
Condensate Tray	Wipe any wet surfaces with a dilute cleaning solution, such as Milton.
Condensate Drain	Check the condensate drain tube is secure and clear. Clean if necessary.

### 5-Yearly Maintenance

The following 5-yearly maintenance is recommended:

*Table 7: 5 Yearly Maintenance*

Item	Action
Battery	Replace the battery on the Main Controller PCB (type BR1225 3 V). Ensure positive (+) side is uppermost (i.e. visible) when replaced. Adjust the clock to agree with the local time. (see <i>Day/Time/Temp/On Off Mode Screen</i> on page 43).

## Removal/Replacement of Parts (Mini & Midi)

### Removal/Replacement of Parts (Mini & Midi)



#### WARNING

THIS EQUIPMENT PRESENTS ELECTRICAL, MECHANICAL AND NOISE HAZARDS. FAILURE TO USE SAFE WORKING PRACTICES AND OBSERVE THE RELEVANT REGULATIONS MAY RESULT IN DEATH OR SERIOUS INJURY. REMOVAL AND REPLACEMENT OF PARTS SHOULD ONLY BE PERFORMED BY QUALIFIED AND VENT-AXIA APPROVED SERVICE ENGINEERS.

The following parts can be replaced in the event of failure or maintenance:

- Motors
- Water pump
- Filters

See *Appendix B: Options and Accessories* on page 63 for part numbers.

The procedure for replacing these parts is dependent on whether access to the unit can be gained from above (if roof-mounted) or from below (if ceiling-mounted).

### Cover Removal/Replacement

The Top and Bottom Covers are arranged in two halves, designed to be removed separately.

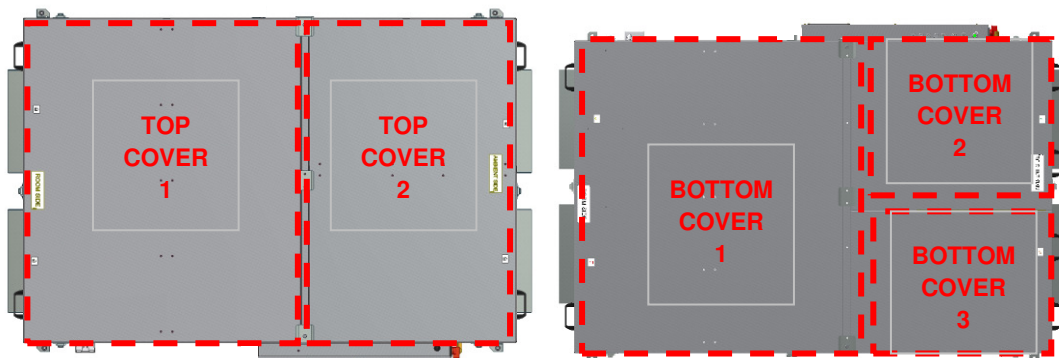

**Totus 2 Midi & Mini top cover**

**Totus 2 Midi bottom cover**

**Totus 2 Mini bottom cover**

# Removal/Replacement of Parts (Mini & Midi)

## Removal

1. Turn the unit off.
2. Release the thumb-catches securing the cover to the chassis. Catches to secure each cover are positioned at the corners of the unit and half-way along the short sides. This will release the air-tight seal

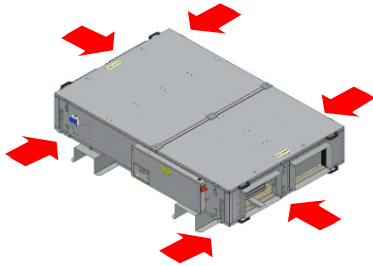

Thumb-catches secure the top covers to the unit chassis. The bottom covers are secured in the same way.

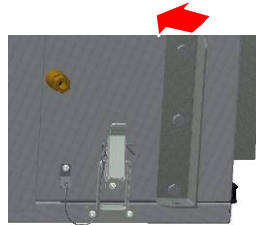

Thumb-catches secure the top & Bottom covers to the unit chassis.

3. In turn, grab hold of the two handles on each cover. Lift up the outer edge of the each cover slightly, and pull it out from underneath the retaining bar in the middle of the unit, to reveal the internal parts of the unit.

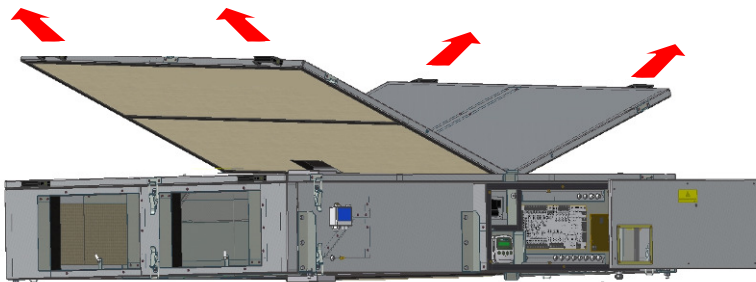

### Removal of Top Covers when Roof-Mounted

Lift and slide the covers out in the direction of the arrows.

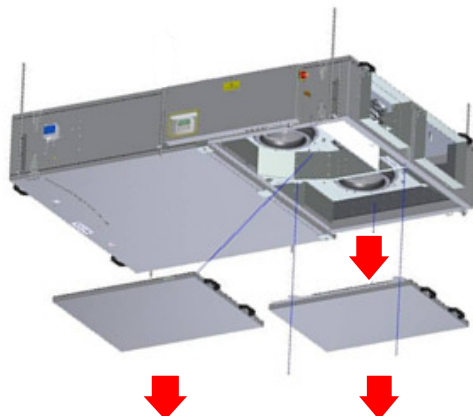

### Removal of Bottom Covers when Ceiling-Mounted

Open Thumb-catches of Bottom covers to the unit chassis

Remove Bottom Cover2



# Removal/Replacement of Parts (Mini & Midi)

## Replacement

1. Ensure that each cover is slotted firmly back into its retaining slot in the middle of the unit.
2. Re-attach the thumb-catches at the corners of the unit to secure the cover to the chassis. Visually check the integrity of the air-tight seal around the lid.

### Note

The unit will not operate correctly unless the covers are correctly fitted to the unit.

## Filter Removal/Replacement (Roof-Mounted)

Filters are fitted to both the internal and external inlets to prevent dust being drawn into the unit. The unit records when new (clean) filters are fitted to the unit and a timer is used to count down the number of days to replacement (see *Filter Screen* on page 29). Filters must be removed / replaced when the counter reaches **000**.

**Filter**  
**Days To Go 000**

### Removal

1. Turn the unit off.
2. Remove both of the top covers (see *Cover Removal/Replacement* on page 47).
3. Remove each filter by holding it firmly along its edge and pulling it upward out of the filter slot (the filter is a push-fit item and not fastened in place).

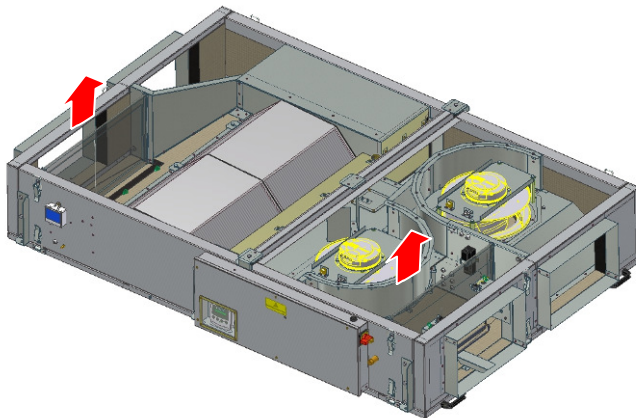

Filters at either end of the unit may be removed / replaced by sliding them out / in the filter slot.

### Replacement

1. Ensure that the new (clean) filters are firmly pushed back into their slots.
2. Replace the top covers (see *Cover Removal/Replacement* on page 47).
3. If filter replacement is as a result of the counter reaching **000**, as indicated by the Commissioning Interface, use the ▲ (Up) and ▼ (Down) push-buttons to select **Yes** and reset the timer (see *Filter Screen* on page 29).

## Filter Removal/Replacement (Ceiling-Mounted)

### Removal

1. Turn the unit off.
2. Remove Panel 3 and the Filter Panel

## Removal/Replacement of Parts (Mini & Midi)

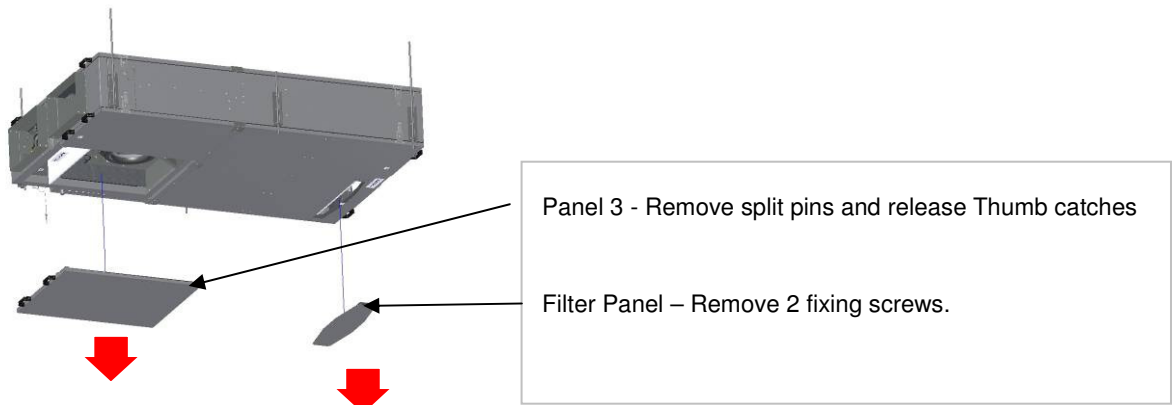

3. Remove each filter by holding it firmly along its edge and pulling it downward out of the filter slot (the filter is a push-fit item and not fastened in place).

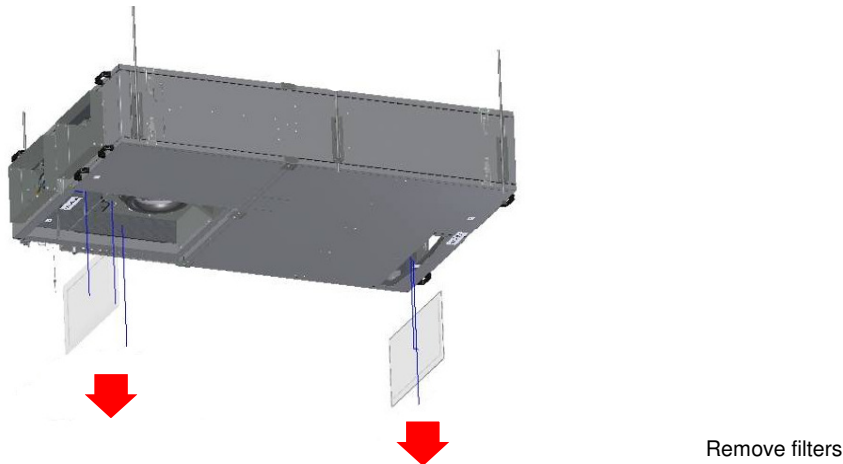

### Replacement

1. Ensure that the new (clean) filters are firmly pushed back into their slots.
2. Replace the access panels with the four screws.
3. If filter replacement is as a result of the counter reaching **000**, as indicated by the Commissioning Interface, use the ▲ (Up) and ▼ (Down) push-buttons to select **Yes** and reset the timer (see *Filter Screen* on page 29).

## Motor Removal/Replacement (Roof-Mounted)

Two DC motors are used to draw-in and extract air from the unit. Both are positioned at the external ambient-air side of the unit and can be accessed by removing a single top cover, when roof mounted.

### Removal

1. **Turn the Unit off.**
2. Remove the top cover at the external ambient-air side of the unit (see *Cover Removal/Replacement* on page 47).
3. Disconnect the motor leads/Molex connector.
4. Unscrew, and retain, the four screws securing each motor to its mounting plate on the chassis.

## Removal/Replacement of Parts (Mini & Midi)

5. Withdraw the motor(s) upward from the unit.

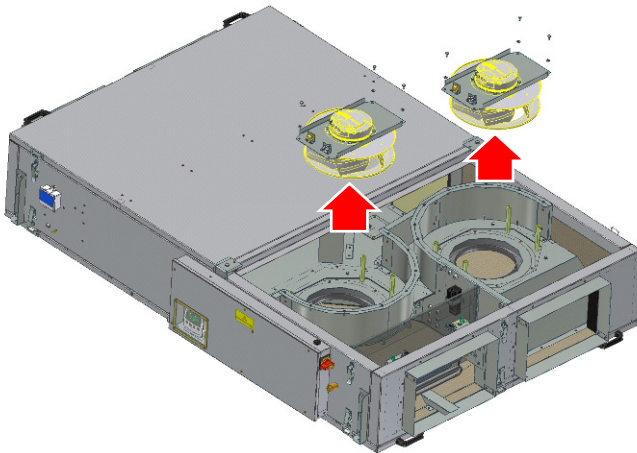

Two motors are used to pull and push air through the unit.

6. Unscrew, and retain, the four screws securing each motor to its mounting plate.

### Replacement

1. Place each new motor inside the unit back onto its mounting plate.
2. Secure the motor assemblies to their mounting plates using the four screws.
3. Reconnect the motor leads/Molex connector.
4. Switch on the unit and check that the air-flow (direction) is correct.
5. Replace the top cover (see *Cover Removal/Replacement* on page 47).

### Motor Removal/Replacement (Ceiling-Mounted)

Two DC motors are used to draw-in and extract air from the unit. Both are positioned at the external ambient-air side of the unit and can be accessed by removing a single bottom cover, when ceiling mounted.

#### Removal

1. **Turn the Unit off.**
2. Remove the bottom cover at the external ambient-air side of the unit (see *Cover Removal/Replacement* on page 47).
3. Disconnect the motor leads/Molex connector.
4. Unscrew, and retain, the four screws securing each motor mounting plate to the chassis.
5. Withdraw each motor and its mounting plate downward from the unit.

## Removal/Replacement of Parts (Mini & Midi)

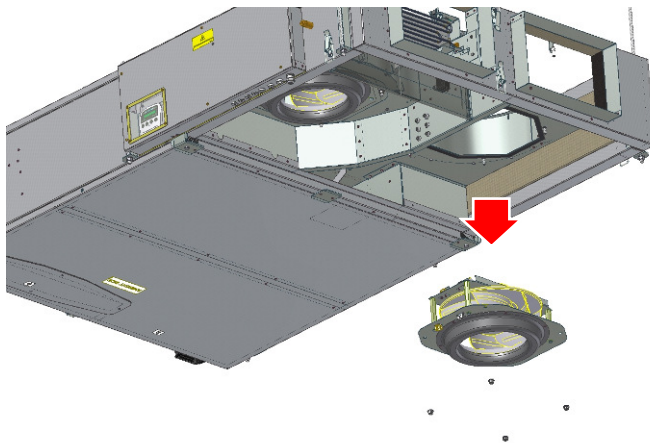

Motors may be removed from underneath when ceiling mounted.

6. Unscrew, and retain, the four screws securing each motor to its mounting plate.

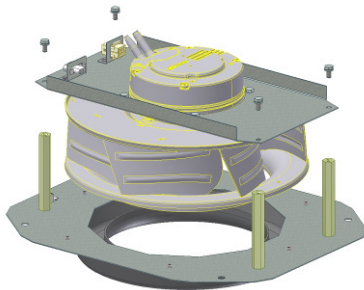

Motor and mounting plates.

### Replacement

1. Secure each motor to its mounting plate using four screws.
2. Place the new motor and its mounting plate back inside the unit into position.
3. Secure the motor assemblies mounting plates to the chassis using the four screws.
4. Reconnect the motor leads/Molex connector.
5. Switch on the unit and check that the air-flow (direction) is correct.
6. Replace the bottom cover (see *Cover Removal/Replacement* on page 47).

### Float Switch Removal/Replacement (Roof-Mounted)

A Float Switch is used to trigger a water pump when there is a build up of condensation within the unit. It is located immediately underneath a square access panel and accessed through the top of the unit, when roof-mounted.

#### Removal

1. **Turn the unit off.**
2. Remove the top cover at the external ambient-air side of the unit (see *Cover Removal/Replacement* on page 47).
3. Remove the square access panel by unscrewing the four retaining screws.

## Removal/Replacement of Parts (Mini & Midi)

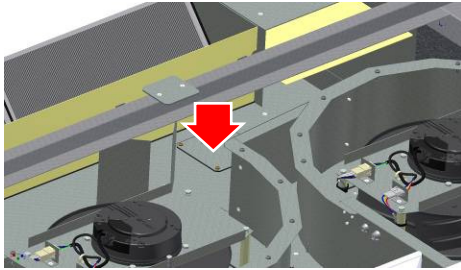

When accessed from the top of the unit, the float switch is located beneath a square access panel.

4. Disconnect the float switch leads/Molex connector.
5. Withdraw the float switch upward from the unit.

### Replacement

1. Place the float switch in position and secure it to the chassis with the retained screws.
2. Reconnect the float switch leads/Molex connector.
3. Replace the square access panel using the four screws.
4. Switch on the unit and check that the float switch operation is correct.
5. Replace the top cover (see *Cover Removal/Replacement* on page 47).

## Float Switch Removal/Replacement (Ceiling-Mounted)

The Float Switch triggers a water pump when there is a build up of condensation within the unit. It is positioned at the external ambient-air side of the unit and can be accessed by removing a single bottom cover, when ceiling-mounted.

### Removal

1. **Turn the unit off.**
2. Remove the bottom cover at the external ambient-air side of the unit (see *Cover Removal/Replacement* on page 47).
3. Disconnect the float switch leads / Molex connector.
4. Unscrew, and retain, the 2 wing-bolts securing the float switch to the chassis plate using your finger and thumb.

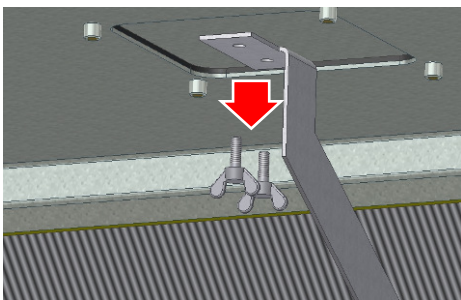

When accessed from underneath the unit, the float switch is screwed to the square access panel.

5. Withdraw the float switch downward from the unit.

## Removal/Replacement of Parts (Mini & Midi)

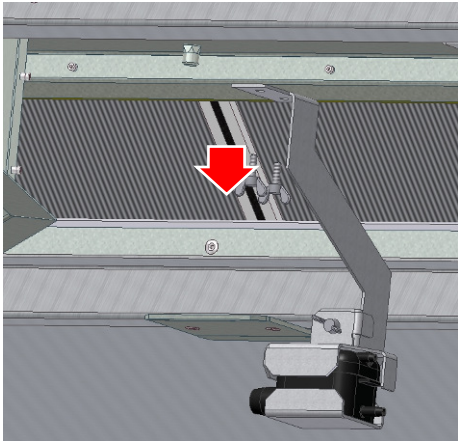

When accessed from underneath the unit, the float switch is screwed to the square access panel.

6. Disassemble the Float Switch from the Float Switch Arm Assembly.

### Replacement

1. Re-assemble the Float Switch Arm Assembly.
2. Place the float switch in position and secure it to the chassis with the 2 retained wing-bolts.
3. Reconnect the float switch leads/Molex connector.
4. Switch on the unit and check that the float switch operation is correct.
5. Replace the bottom cover (see *Cover Removal/Replacement* on page 47).

## Condensate Pump Removal/Replacement (Roof-Mounted)

The condensate pump extracts water from the condensate tray by pumping it up a tube that leads outside the unit. It can be accessed by removing a single top cover when roof-mounted.

### Removal

1. Turn the unit off.
2. Remove the top cover at the external ambient-air side of the unit (see *Cover Removal/Replacement* on page 47).
3. Disconnect the condensate pump leads/Molex connector and disconnect the inlet and outlet water pipes.

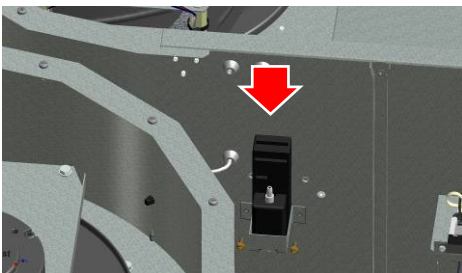

Condensate pump access from the top of the unit (Roof-Mounted).

4. Unscrew, and retain, the 2 screws of the U-shaped bracket securing the condensate pump to the chassis.

## Removal/Replacement of Parts (Mini & Midi)

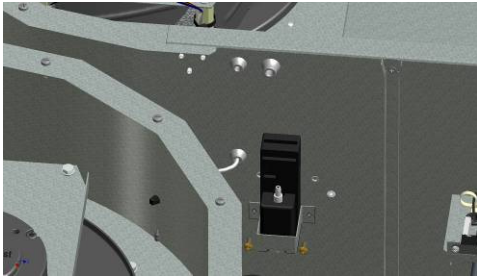

Condensate pump is secured to the chassis by a bracket fixed by 2 screws.

5. Withdraw the condensate pump upward from the unit.

### Replacement

1. Place the condensate pump in position and secure it to the chassis with the U-shaped bracket and 2 retained screws.
2. Reconnect the condensate pump leads/Molex connector and the inlet/outlet water pipes.
3. Switch on the unit and check that the float switch operation is correct.
4. Replace the top cover (see *Cover Removal/Replacement* on page 47).

## Condensate Pump Removal / Replacement (Ceiling-Mounted)

The condensate pump extracts water from the condensate tray by pumping it up a tube that leads outside the unit. It can be accessed by removing a single bottom cover when ceiling-mounted.

### Removal

1. **Turn the unit off.**
2. Remove the bottom cover at the external ambient-air side of the unit (see *Cover Removal/Replacement* on page 47).
3. Disconnect the condensate pump leads/Molex connector and the inlet/outlet water pipes.

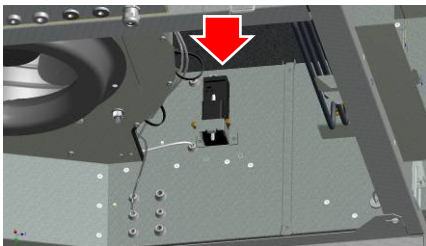

Condensate pump access from the bottom of the unit (Ceiling – Mounted).

4. Unscrew, and retain, the 2 screws of the U-shaped bracket securing the condensate pump to the chassis.
5. Withdraw the condensate pump downward from the unit.

### Replacement

1. Place the condensate pump in position and secure it to the chassis with the U-shaped bracket and 2 retained screws.
2. Reconnect the condensate pump leads/Molex connector and the inlet/outlet water pipes.
3. Switch on the unit and check that the water pump operation is correct.
4. Replace the bottom cover (see *Cover Removal/Replacement* on page 47).

### Totus II Maxi Filter Removal / Replacement

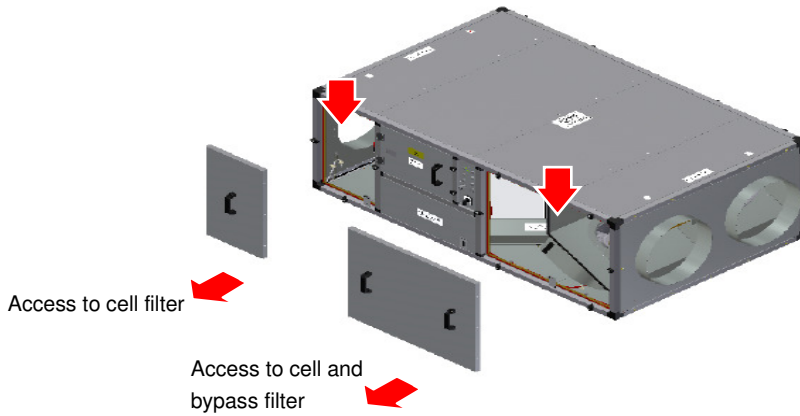

1. Remove panels 3 and 4 as shown above.
2. Remove cell filters out of panels 3 and 4.
3. Replace cell filters and close panels 3 and 4.
4. For bypass filter follow instructions on commissioning screen when removing bypass flap through PCB.
5. Once bypass flap opens, pull the bypass filter to the outside by using the tie.
6. Place back the filter by bending and place in brackets.
7. Close panels.



## Removal/Replacement of Parts (Mini & Midi)

### List of Spares

The table below lists the spares for the Totus 2 Mini, Midi & Maxi:

Description	Part Number (Mini)	Part Number (Midi)	Part Number (Maxi)
MAIN PCB ASSEMBLY SPARE	447250	447250	447250
MOTOR ASSEMBLY SPARE	445850	446643	444967
ROOM CONTROLLER SPARE	437141	437141	437141
POWER SUPPLY PCB SPARE	446645	446645	446645
FILTER PACK (2 PER PACK) G4 SPARE	445851	447251	442071
F6 FILTER CONVERSION KIT*	445852	446607	-
FILTER PACK (2 PER PACK) F6 SPARE	407882	447252	-
CONDENSATE PUMP SPARE	445038	445038	445038
HEAT RECOVERY CELL SPARE	445853	447254	-
THERMISTOR PACK (T1,T2,T3 & T4) SPARE	447255	447255	445042
ISOLATOR SWITCH SPARE	447256	447256	474468
NEON ASSEMBLY SPARE	445049	445049	445049
ACTUATOR KIT SPARE	447258	447258	443433
HEATER & BRACKET ASSY SPARE	445854	ASSY 1: 447253 ASSY 2: 447259	446028
CP CONVERSION KIT	-	-	445482
Pressure Transducer KIT	446848	446848	-
Turnbuckles (Pair)	-	-	445040
Bypass Filter	-	-	407752

\*F6 Filter conversion kit is required if F6 filters are to be fitted to the totus unit.

## Troubleshooting

### Diagnosing a Problem

In the event of a problem, always troubleshoot the unit according to:

- **Diagnostic code** displayed on the Commissioning Interface.
- **Fault LED** on the Commissioning Interface and cable entry panel.
- **Check fuses** on the Main Controller PCB.

If no indications are displayed, then troubleshoot problem according to the fault symptom as described in the following tables.

### Diagnostic Codes

A diagnostic code screen is displayed on the Commissioning Interface in the event that a fault has occurred which resulted in the unit operation being stopped and placed into standby.

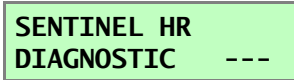

The following diagnostic codes may be viewed on the Commissioning Interface.

Table 8: Diagnostic Codes

Problem	Code	Description															
Thermistors	1-255	<table style="width: 100%; border: none;"> <tr> <td style="text-align: center;">T1</td> <td style="text-align: center;">T2</td> <td style="text-align: center;">T3</td> <td style="text-align: center;">T4</td> <td></td> </tr> <tr> <td style="text-align: center;">+1</td> <td style="text-align: center;">+2</td> <td style="text-align: center;">+4</td> <td style="text-align: center;">+8</td> <td>= Short Circuit</td> </tr> <tr> <td style="text-align: center;">+16</td> <td style="text-align: center;">+32</td> <td style="text-align: center;">+64</td> <td style="text-align: center;">+128</td> <td>= Open Circuit</td> </tr> </table> <p>Thermistors are checked continuously and one or more has to be at fault for 60 seconds before triggering this diagnostic stop.</p>	T1	T2	T3	T4		+1	+2	+4	+8	= Short Circuit	+16	+32	+64	+128	= Open Circuit
T1	T2	T3	T4														
+1	+2	+4	+8	= Short Circuit													
+16	+32	+64	+128	= Open Circuit													
Pump float switch open	300	Pump float switch is checked continuously and has to be open (i.e. fault or excess condensate) for 120 seconds before triggering this diagnostic stop. If the unit is 'Off' then pump mains is turned on after 30 seconds to try to reduce the water level.															
Fan 1 extract relay open	310	Fan relays are checked when HR is ON, either relay has to be open for 60 seconds before triggering this diagnostic stop. This is a NC relay on board the motor itself. It goes open when motor detect fault.															
Fan 2 intake relay open	320	Fan relays are checked when HR is ON, either relay has to be open for 60 seconds before triggering this diagnostic stop. This is a NC relay on board the motor itself. It goes open when motor detect fault.															
24 V sensor supply fuse blown	330	24 V sensor supply fuse is checked when the unit is switched on and has to be open for 10 seconds before triggering this diagnostic stop.															
Pressure sensor in CP mode	340	Pressure sensor is checked when HR is ON and in CP mode. The sensor signal has to be below the CP preset threshold ( value from factory test ) whilst the fan speed is greater than 50% for 60 seconds before triggering this diagnostic stop.															
Commissioning Interface but no data from HR	360	A 360 code indicates power to the remote control but no data, a wiring fault or failure on the heat recovery board.															

## Fault LED/Status Relay

A Status relay, provided by the Main Controller PCB, indicates a fault occurring on the unit. A flashing red or red/green LED indicator on the Commissioning Interface, and on the unit cable entry panel, indicate this locally.

The status relay contacts enable remote status monitoring for the fault conditions, which may be connected to an external indicator or BMS, etc. (see *Appendix C: Main Controller PCB Terminals* on page 64 for connector details).

Table 9: Fault LED/Status LED Indications

Indication	Possible Problem	Action
Flashing Red	Thermistor failure	Check sensor operation and replace as necessary,
Flashing Red	Condensate sump is full and if the unit is running	Check operation of the float switch and pump. Replace if necessary Check that the pipe carrying the water to the condensate drain is not split, disconnected or kinked. Replace if necessary.
Flashing Red	Fan failure	Check fan operation and replace as necessary,
Flashing Red	24 V sensor supply is shorted or fuse failure	Check sensor operation and replace as necessary,
Flashing Red	Pressure sensor failure	Check sensor operation and replace as necessary,
Flashing Red	Bypass has not reached its intended position	Check whether bypass is motion has stuck or has failed and replace as necessary.
Flashing Red	Commissioning Interface is disconnected or has a fault	Check the connections and cable running between the Main Controller PCB terminals to the Commissioning Interface terminals. Replace/rewire as necessary.
Flashing Red/Green	Filter hours have been exceeded	Replace the filters and reset the Filters commissioning screen (see <i>Filter Screen</i> on page 29).
Flashing Red	Heating Failure condition	Check heater operation and replace as necessary,
Flashing Red	Shutdown by Defrost Bypass mode	Check bypass operation and replace as necessary,

## Power Supply Troubleshooting

Troubleshoot according to the fault symptoms. If the fault cannot be rectified, contact your local dealer or sales office for a service engineer.

Table 10: Power Supply Troubleshooting

Symptom	Possible Problem	Action
No Power Supply (unit dead)	External Power Supply Failure	Check external power source is available and switched on.
	Distribution Board Input Fuse/RCD	Check fuse, or RCD if used, at distribution board. Replace/reset if necessary.
	Main Controller PCB Fuses	Check fuses on the Main Controller PCB and Power Supply PCB, see <i>Figure</i> . Replace if necessary.
	Other	Contact Vent-Axia Technical Support.
No 24 V supply (at sensors/switches)	Fuse F2	Check fuses on the Main Controller PCB and Power Supply PCB, see <i>Figure</i> below.
	Main Controller PCB	Contact Vent-Axia Technical Support.

## Internal Fuses

Internal fuse are provided on the Power Supply PCB and the Main Controller PCB for the protection the unit.

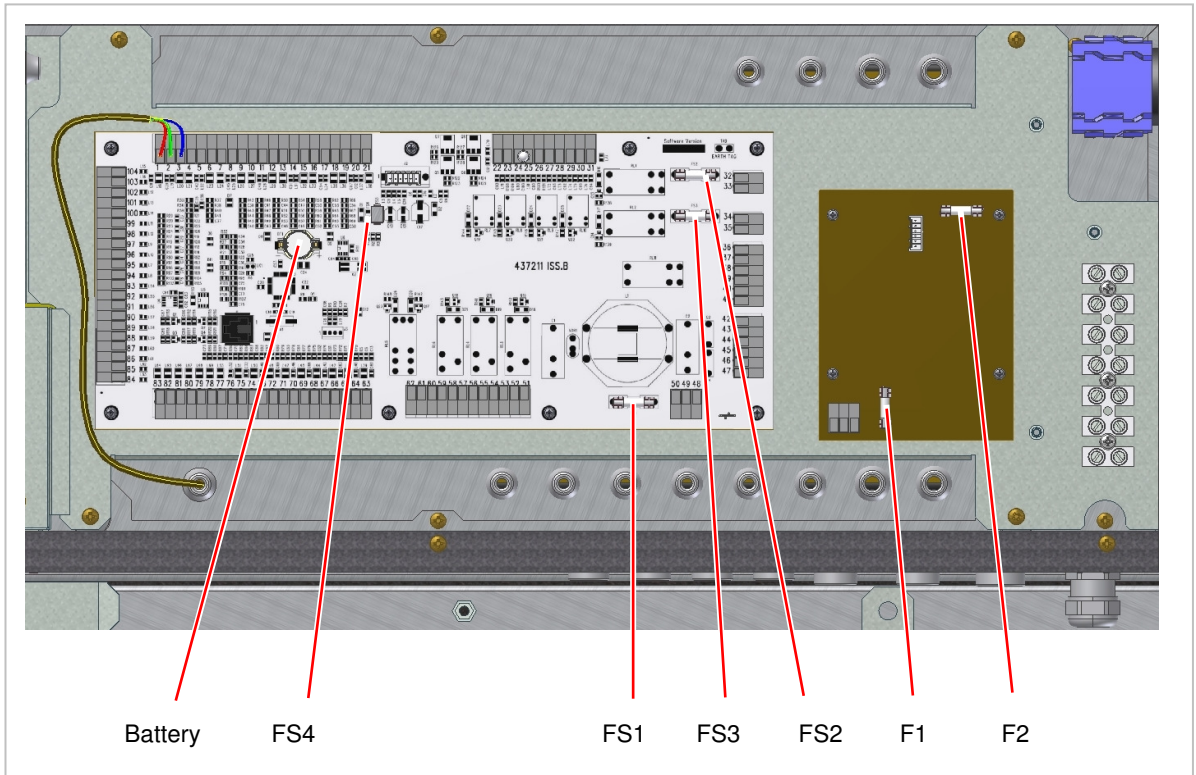

Figure 26: Internal Fuses

The following table lists the fuse values and types.

Table 11: Internal Fuse Values and Types

PCB	Label	Fuse Type	Purpose
Main Controller PCB	FS1	Ceramic 10 A anti-surge	Motors, pump and PSU.
	FS2	Ceramic 10 A anti-surge	Heater 1.
	FS3	Ceramic 10 A anti-surge	Heater 2.
	FS4	Polyfuse 600 mA auto-resetting	Switches, sensors and dampers.
Power Supply PCB	F1	Glass ceramic 500 mA anti-surge	Input supply.
	F2	Glass 1.25 A quick-blow	Main 24 V dc out.

## Airflow/Temperature Troubleshooting

Troubleshoot according to the fault symptoms. If the fault cannot be rectified, contact your local dealer or sales office for a service engineer

Table 12: Airflow/Temperature Troubleshooting

Symptom	Possible Problem	Action
No airflow or Maximum airflow	Settings	Check the Commissioning Interface Status LED and display screens for alarm indications/messages. Check commissioning settings are correct – compare code with that written on the Installer Notice label. Re-instate settings, if necessary.

Symptom	Possible Problem	Action
	Switches/Sensors/Dampers	Check operation of switches, sensors and dampers. Check the unit responds to switch and sensor signals.
	Ducting	Check that ducting has not become loose or disengaged at any point along the airflow.
	Unit	Check airflow entering and leaving the ventilation unit. Check internal fuses. Replace as necessary. Check operation of motors. Replace if necessary. Restore settings.
Summer Bypass Operating	Summer Bypass jammed	Connect 9V battery to terminal 22 & 23.

## Condensate Troubleshooting

Troubleshoot according to the fault symptoms. If the fault cannot be rectified, contact your local dealer or sales office for a service engineer

Table 13: Condensate Troubleshooting

Symptom	Possible Problem	Action
Condensation water not being pumped out	Trigger switch	Check the operation of the float switch at the corner of the condensate tray. Replace if necessary.
	Pump	Check the operation of the pump. Replace if necessary.
	Pipe	If the switch and pump are both operational, check that the pipe carrying the water to the condensate drain is not split, disconnected or kinked. Replace if necessary.
	External condensate pipe frozen	Fit Raychem FrostGuard frost protection cable for pipes.
	Other	Contact Vent-Axia Technical Support.
Pump running continuously	Pump	Check the operation of the float switch inputs. Replace pump if necessary.
	Trigger switch	Check the operation of the float switch. Replace if necessary.

### Appendix A: Glossary

#### Terms and Abbreviations

The following technical terms and abbreviations are used in this manual.

Term/Abbreviation	Description
<b>AQS</b>	Air Quality Sensor
<b>BMS</b>	Building Management System
<b>CO<sub>2</sub></b>	Carbon Dioxide
<b>CP</b>	Constant Pressure
<b>D-ERV</b>	Demand Energy Recovery Ventilation
<b>EC/DC</b>	Electrically Commutated Direct Current motor
<b>EEPROM</b>	Electrically Erasable-Programmable Read-Only Memory
<b>HRU</b>	Heat Recovery Unit
<b>LCD</b>	Liquid Crystal Display
<b>LED</b>	Light Emitting Diode
<b>Min/Max</b>	Minimum (trickle)/Maximum (boost)
<b>P-Band</b>	Proportional Control Range
<b>PC</b>	Proportional Control
<b>PCB</b>	Printed Circuit Board
<b>PID</b>	Proportional Integral Derivative control
<b>RCD</b>	Residual Current Device
<b>SBP</b>	Summer Bypass
<b>SELV</b>	Separated Extra-Low Voltage. IEC 61140 defines a SELV system as "an electrical system in which the voltage cannot exceed ELV under normal conditions, and under single-fault conditions, <i>including</i> earth faults in other circuits".
<b>T<sub>1</sub></b>	Temperature of the fresh ambient air entering the unit from outside
<b>T<sub>2</sub></b>	Temperature of the fresh air entering the room (supply)
<b>T<sub>3</sub></b>	Temperature of the stale air leaving the room (exhaust)
<b>T<sub>4</sub></b>	Temperature of the stale air discharged to the outside ambient
<b>T<sub>c</sub></b>	Comfort setting
<b>PIR</b>	Passive Infra-Red Sensor
<b>VFC</b>	Voltage-Free Contact

### Appendix B: Options and Accessories

#### Sentinel Totus

The following options and accessories are available for the Sentinel Totus.

No	Item	Control Type	Part Number	Description
<b>Sensors and Switches</b>				
1.	Air Quality Sensor (AQS)	Switch	432953	<ul style="list-style-type: none"> <li>▪ Measures VOC level (adjustable)</li> <li>▪ Adjustable run-on timer 1-25 min</li> </ul>
2.	Passive Infra-red Sensor (PIR)	Switch	433162	<ul style="list-style-type: none"> <li>▪ Person detection</li> <li>▪ Adjustable run-on timer 5-25 min</li> </ul>
3.	Humidity Switch	Switch	432949	<ul style="list-style-type: none"> <li>▪ Adjustable humidity sensing level 65 – 90%</li> </ul>
4.	Ambient Response Humidistat	Switch	432945	<ul style="list-style-type: none"> <li>▪ Fixed humidity sensing at 72/75% RH</li> <li>▪ Incorporates night setback</li> </ul>
5.	Time switch	Switch	563515	<ul style="list-style-type: none"> <li>▪ 7/24 mechanical type</li> <li>▪ Maximum 6 cycles/day</li> </ul>
6.	Thermostat	Switch	563502B	<ul style="list-style-type: none"> <li>▪ Adjustable 6-30°C</li> </ul>
7.	Remote Speed Control	Proportional	426332	<ul style="list-style-type: none"> <li>▪ Manual fan motor speed control (24 V dc)</li> </ul>
8.	Carbon Dioxide	Proportional	433257	<ul style="list-style-type: none"> <li>▪ Control level settable up to 2000 ppm CO<sub>2</sub> and 50°C</li> <li>▪ 24 V dc</li> </ul>
9.	Carbon Dioxide Duct Probe	Proportional	433259	<ul style="list-style-type: none"> <li>▪ Control level settable up to 2000 ppm CO<sub>2</sub></li> <li>▪ 24 V dc</li> </ul>
10.	Remote Fan Status Indicator	Visual Display	433816	<ul style="list-style-type: none"> <li>▪ Indicates fan running condition OK. Will flag fan failure.</li> </ul>
<b>Constant Pressure</b>				
11.	Power Supply	24 V dc	433193	<ul style="list-style-type: none"> <li>▪ 24 W maximum output</li> </ul>
12.	Damper Assembly	MIN-MAX positioning	DVD100/MM to DVD315/MM	<ul style="list-style-type: none"> <li>▪ Sizes 100 – 315 mm</li> <li>▪ 24 V dc actuator</li> </ul>
13.	Damper Assembly	Proportional 0-10 V	DVD100/PCM to DVD315/PC	<ul style="list-style-type: none"> <li>▪ Sizes 100 – 315 mm</li> <li>▪ 24 V dc actuator</li> </ul>
14.	PIR Grille Kit	PIR/Humidity controlled damper	434184	<ul style="list-style-type: none"> <li>▪ 125 mm size ducting</li> <li>▪ 12 V ac transformer supplied with kit</li> <li>▪ Mechanical humidity control included</li> </ul>
<b>Roof Mounting</b>				
15.	Cowl (Midi)		403460	<ul style="list-style-type: none"> <li>▪ Weatherproof cowl</li> </ul>
16.	Cowl (Mini)		445832	<ul style="list-style-type: none"> <li>▪ Weatherproof cowl</li> </ul>





## Appendix C: Main Controller PCB Terminals

### Appendix C: Main Controller PCB Terminals

#### Terminals

The following table details the terminals on the Main Controller PCB.

Terminal No.	Name	Description
1-3	-	Factory use only
4-6	CO <sub>2</sub> Internal 0-10 V	24 V supply available to sensor, 0-10 V sensor input
7- 9	Proportional Temp 0-10 V	24 V supply available to sensor, 0-10 V sensor input
10-12	Proportional CO <sub>2</sub> 0-10 V	24 V supply available to sensor, 0-10 V sensor input
13-15	Proportional Humidity 0-10 V	24 V supply available to sensor, 0-10 V sensor input
16-18	Remote/Local 0-10 V	24 V supply available to sensor, 0-10 V sensor input
19-21	BMS Proportional 0-10 V	24 V supply available to sensor, 0-10 V sensor input
22-25	-	Factory use only
26-28	Damper 1	Open – 24 V (on) when HR is on and dampers are opening Close – 24 V (on) when HR is on and dampers are closing
29-31	Damper 2	Open – 24 V (on) when HR is on and dampers are opening Close – 24 V (on) when HR is on and dampers are closing
32-50	-	Factory use only
51-53	Air Conditioning Enable	On when (HR time clock or switch enable or always on) is on Off when HR is off Off when running in Overheat mode
54-56	Heater Interlock Enable	On when (HR time clock or switch enable or always on) is on Off when HR is going off – fans run for run on time Off when running in Overheat mode
57-59	Filter	On when HR is on and filter time has elapsed Off when HR is off Off when HR is on and filter time has not elapsed
60-62	Status	On when HR is on Off for a fault condition. The Status LED flashes red when the relay is off. See <i>Table 9: Fault LED/Status LED Indications</i> on page 59
63-65	Switch 5 BMS Enable	Closed = HR on, Open = HR off
66-68	Switch 4 Central Heating	Closed = heating off (enables Overheat), Open = heating on
69-71	Switch 3 Min-Max 24 V	Closed = max speed, Open = min speed
72-74	Switch 2 Min-Max 24 V	Closed = max speed, Open = min speed
75-77	Switch 1 Enable On/Off	Closed = HR on, Open = HR off
78-83	-	Factory use only
84-87	Commissioning Interface Connection	PCB terminals 1-4 connect to the Commissioning Interface terminals 1-4





# **Vent-Axia**

Head Office: Fleming Way, Crawley, West Sussex, RH10 9YX.

**UK NATIONAL CALL CENTRE**, Newton Road, Crawley, West Sussex, RH10 9JA

SALES ENQUIRIES:           Tel: 0844 8560591           Fax: 01293 534898

TECHNICAL SUPPORT        Tel: 0844 8560595           Fax: 01293 455197

For details of the warranty and returns procedure please refer to [www.vent-axia](http://www.vent-axia) or write to Vent-Axia Ltd, Fleming Way, Crawley, RH10 9YX