

NBR DMEV

100mm & 125mm
CONTINUOUS EXTRACT FAN RANGE

Installation and Wiring Instructions



Stock Ref. N°

475142A - NBR DMEV 100
473809A - NBR DMEV 100 HT

494147 - NBR DMEV 125
494148 - NBR DMEV 125 HT

220-240V~50Hz

Vent-Axia[®]

PLEASE READ INSTRUCTIONS IN CONJUNCTION WITH ILLUSTRATIONS.
PLEASE SAVE THESE INSTRUCTIONS.

UK
CA
IPX5
CE

Installation and Wiring Instructions for the NBR DMEV Range of Extractor Fans.



IMPORTANT: READ THESE INSTRUCTIONS BEFORE COMMENCING THE INSTALLATION

DO NOT install this product in areas where the following may be present or occur:

- Excessive oil or a grease laden atmosphere.
- Corrosive or flammable gases, liquids or vapours.
- Ambient temperatures higher than 40°C or less than -5°C.
- Possible obstructions which would hinder the access or removal of the Fan.

SAFETY AND GUIDANCE NOTES

- A.** All wiring to be in accordance with the current I.E.E. Regulations, or the appropriate standards of your country and **MUST** be installed by a suitably qualified person.
- B.** The Fan is suitable for installation within Zones 1 & 2.
- C.** The Fan should be provided with a local isolator switch capable of disconnecting all poles, having a contact separation of at least 3mm.
- D.** Ensure that the mains supply (Voltage, Frequency, and Phase) complies with the rating label.
- E.** The Fan should only be used in conjunction with the appropriate Vent-Axia products.
- F.** The fan should only be used in conjunction with fixed wiring.
- G.** When the Fan is used to remove air from a room containing a fuel-burning appliance, ensure that the air replacement is adequate for both the fan and the fuel-burning appliance.
- H.** The Fan should not be used where it is liable to be subject to direct water spray for prolonged periods of time.
- I.** Where ducted Fans are used to handle moisture-laden air, a condensation trap should be fitted. Horizontal ducts should be arranged to slope slightly downwards away from the Fan.

- J.** This appliance is not intended for use by persons (including children) with reduced physical, sensory or mental capabilities, or lack of experience and knowledge, unless they have been given supervision or instruction concerning use of the appliance by a person responsible for their safety.
- K.** Young children should be supervised to ensure that they do not play with the appliance.

DESCRIPTION

The NBR DMEV fan is a continuously running extract fan for kitchens, utility rooms, bathrooms and toilets.

The product incorporates an airflow detection system that detects the installation duct resistance and maintains the correct fan speed to achieve the preset extract flow rate.

The incorporated LED display allows the installer to configure the fan to suit its installation.

The fan can be wall, window (100mm only) or panel/ceiling mounted.

ACCESSORIES (not supplied)

- **WALL FITTING KIT** - A range of white (stock ref. 254102), brown (stock ref. 254100) 100mm wall kits & White (Stock ref. 455226) 125mm wall kits are available for installing into most walls using telescopic liners supplied.
- **WINDOW KIT** stock ref. 407927 (100mm only)
- **CEILING KIT** stock ref. 407928 (100mm only)
- **150mm CONVERSION KIT** stock ref. 408680 (100mm only)
- **Decoration Frame** stock ref. 474041 (100mm only)

A. INSTALLATION

PANEL/CEILING/ INTERIOR WALL MOUNTING

1. Cut a 107mm diameter hole (100mm fans) or a 130mm hole for (125mm fans).
2. Remove the front panel by carefully pulling it away from the fan. Loosen the two self-retaining screws and remove the inner grille by carefully pulling it away from the housing.
3. Using the built in spirit level bubble as an aid. Mark the screw centres through the holes in the fan back plate. Drill, plug and screw into position. Attach ducting as required for the installation.
4. Wire the fan as described in Section B-Wiring. Adjust any settings as required (see Section C-Setup).
5. After installation, ensure impeller rotates freely.
6. Replace the inner grille and tighten the retaining screws.
7. Replace the front panel.

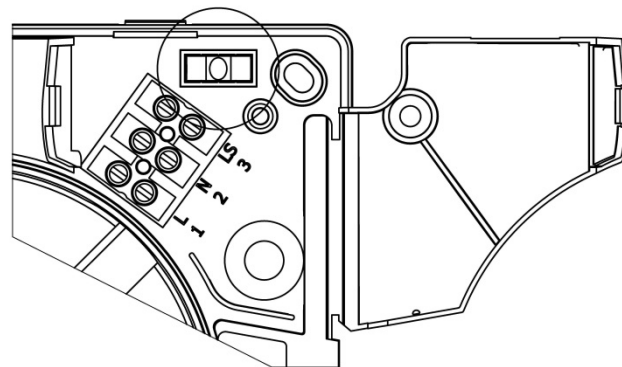
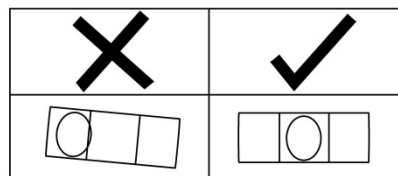

Open up the internal cover to access
The spirit level bubble

EXTERIOR WALL MOUNTING

1. For wall mounting cut a 117mm diameter hole (100mm fans) or a 140mm hole (125mm fans) through the wall and insert the wall sleeve. Slope the sleeve slightly downwards away from the fan. Where necessary cut to length and cement both ends into position flush with the wall faces.
2. Fix exterior grille into position with the louvres positioned downwards.
3. Remove the front panel by carefully pulling it away from the fan. Loosen the two self-retaining screws and remove the inner grille by carefully pulling it away from the housing.
4. Using the built in spirit level bubble as an aid. Mark the screw centres through the holes in the fan back plate. Drill, plug and screw into position.
5. Wire the fan as described in Section B-Wiring. Adjust any settings as required (see Section C-Setup).
6. After installation, ensure impeller rotates freely.
7. Replace the inner grille and tighten the retaining screws.
8. Replace the front Panel.

WINDOW MOUNTING (100MM ONLY)

For window mounting refer to the instructions provided with the kit.

B. WIRING.



WARNING: THE FAN AND ANCILLARY CONTROL EQUIPMENT MUST BE ISOLATED FROM THE POWER SUPPLY DURING INSTALLATION OR MAINTENANCE.

IMPORTANT

- The cross - sectional area of supply cord used should be ranged from 0.75 -1.5mm².
- The extraction fan is suitable for connection to 220-240V 50Hz supply.
- The fan is a class II double insulated product and **MUST NOT** be earthed.

1. Select and follow the appropriate wiring diagram.
(Fig. 1, 2, 3)
2. Check all connections have been made correctly and ensure all terminal connections and supply wires are securely fastened.
(Fig. 4)
3. Ensure the impeller rotates and is free from obstructions.

C. SETUP

Accessing the commissioning menu

To configure the fan first remove the grille. With the grille removed the control buttons are visible (Fig.4). Do NOT isolate the fan from the power supply as configuration requires power to the fan.

IMPORTANT



Do NOT attempt to remove the circuit board cover (Fig.4). This covers the high voltage power supply, preventing the risk of an electric shock.

Display modes

When first powered on, the display will run through an initialisation sequence and then activate prism mode (cover on).

When a button is pressed, the display will go into the menu system and display as viewed without the prism.

The display will return to prism mode after 30 seconds of inactivity (i.e. no button presses).

When activating the menu, the initial button push will not change any settings.

Prism Mode

When the controller is in 'prism mode' the display will be mirrored such that the characters are shown correctly when viewed through the prism fitted in the fan cover.



When activated, prism mode will run for 15 minutes, then cycle between displaying:

- Airflow rate
- Estimated duct pressure (if CV / F-2 mode enabled)
- Current RH% (HT models only)

Calibration process will run after the first 15 minutes (if CV / F-2 mode enabled); see Advanced settings for further details.





Menu

If the buttons are pressed the display goes from prism mode to direct view mode and menu activated. If the buttons are not pressed for 30 seconds the display reverts to prism mode.

The  (Up) button is used to increase the value of a setting, the  (Down) button is used to reduce the value of a setting and the  (Mode/Set) button is used to advance to the next menu item.



The fan has the following 'menu' modes:

- Standard (press any button from normal runtime -   )
- Advanced/Engineer (hold  +  for 5 seconds from the standard menu)

Standard settings:

Display text	Configuration Option	Selections			Default
r - n	Rotate display	r-Y = display rotated		r-n = display normal	r-n
t r 1	Trickle speed adjustment	100mm: 0*, 5 to 30 l/s (Max limited by Boost Selection)			6l/s
		125mm: 0*, 9 to 30 l/s (Max limited by Boost Selection)			9l/s
b 5 t	Boost speed adjustment	100mm: 6 to 35 l/s (Min limited by Trickle Selection)			13 l/s
		125mm: 10 to 35 l/s (Min limited by Trickle Selection)			15 l/s
b 15	Boost Overrun time	b0 to b30 – 0 to 30 minutes (0 disables overrun)			15
h 7 0	Humidity level trigger	h40 to h90 - 40% to 90% relative humidity			70% RH
F - 0	Fan Control Mode	F-0 = CV disabled, wall / window installation	F-1 = CV disabled, ducted installation	F-2 = CV Constant Volume enabled	F-0
c - n	Comfort mode	c-n = normal LS overrun		c-Y = comfort mode	c-n

***If “0” is selected, the fan switches to Intermittent mode.**

Advanced settings:

Display text	Configuration Option	Selections			Default
A - 4	RH Ambient Response	A-Y Ambient Response enabled		A-n Ambient Response disabled	Enabled
P - 4	RH Rapid Response enable	p-Y = Rapid Response enabled		p-n = Rapid Response disabled	Y

Settings

Speed selection

Set trickle and boost speeds in l/s by using the  and  buttons.

To convert m³/h to l/s, divide the m³/h by 3.6 (e.g. 54m³/h / 3.6 = 15 l/s).

The Trickle Speed cannot be higher than the Boost selection. Therefore it might be necessary to modify the Boost selection before increasing the Trickle setting.

If “0” is selected for the trickle speed, the fan will be off until a boost signal is activated (for example via LS/humidity).

Boost time

The boost setting allows the boost timer to be adjusted from 1-30 minutes, the default is 15 minutes. This option may also be disabled, thus removing the option from the menu and setting the overrun to 0.

Inbuilt Ambient Response Humidistat with Rapid Rise Detection

The humidity threshold setting defines at what relative humidity the fan will trigger, adjustable from 40% to 90% rH. The fan increases in speed slowly between the trickle and boost speeds between the trigger %rH and +10%. The trigger point will automatically adjust if the temperature drops below 18C to prevent nuisance triggering.

The fan also incorporates a rapid rise function to detect rapid rises in humidity when the ambient %rH is under the threshold setting. If a rapid rise is detected the fan will increase in speed proportionally between the trickle and boost settings until the humidity lowers again.

Comfort mode

- With comfort mode disabled, the fan will go into boost as soon as an LS (Light Switch) input is detected and over-run for the set period after LS is disconnected.
- With comfort mode enabled, the fan will remain off / in trickle up to a maximum of 20 minutes. Once LS is deactivated, fan will run at boost mode for the length of time LS was present up to a maximum of 20 minutes plus the set over-run time.
If the LS was activated for < 3 minutes, no boost will occur to prevent nuisance activations.

Fan Control Mode

There are 3 modes for fan speed control. Wall, ducted and constant airflow/ volume (CV) mode. In wall or ducted mode, the fan speeds are pre-determined at the factory and does not use the airflow sensor.

In CV mode (Constant Airflow/Volume), the fan will automatically adjust the fan speed to maintain the desired airflow. After the first 15 minutes of operation the fan enters calibration mode to determine the most efficient mode of operation.

Calibration Reset

In some circumstances it may be necessary to reset the calibration settings (if the fan was covered to prevent dust/damage/or poor weather outside).

Reset the calibration by configuring the fan for wall or duct mode (F-0 or F-1), turn the product off and on and re-configure back to CV mode (F-2). The fan will calibrate after 15 minutes.

Calibration

The airflow sensor is calibrated at the factory using UKAS accredited equipment. Details of the equipment and certification can be found on the inside of the fan.

D. SERVICING AND MAINTENANCE



WARNING: THE FAN AND ANCILLARY CONTROL EQUIPMENT MUST BE ISOLATED FROM THE POWER SUPPLY DURING MAINTENANCE.

1. At intervals appropriate to the installation, the fan should be inspected and cleaned to ensure there is no build-up of dirt or other deposits.
2. Wipe the inlets and front face with a damp cloth until clean.
Be careful not to push dirt into the airflow sensor.

The fan has sealed for life bearings, which do not require lubrication.

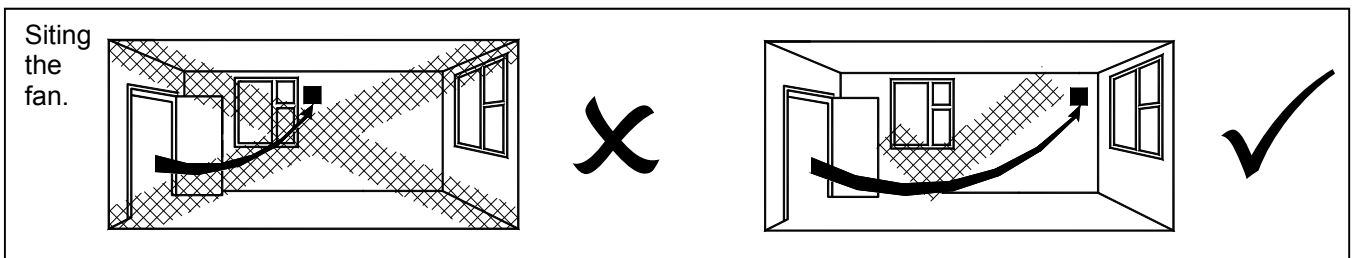

Fig.1 Continuous trickle. (The fan is internally fused)

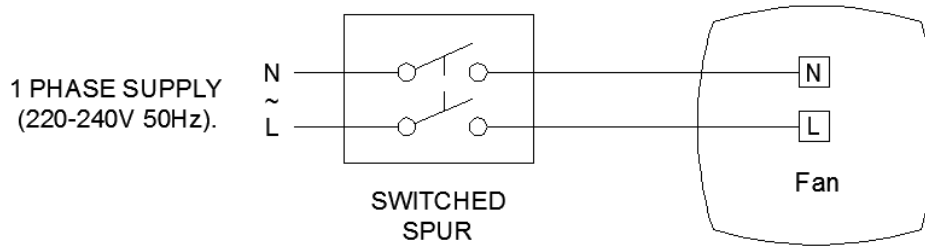

Fig.2 Continuous boost 1 with no trickle facility. (The fan is internally fused)

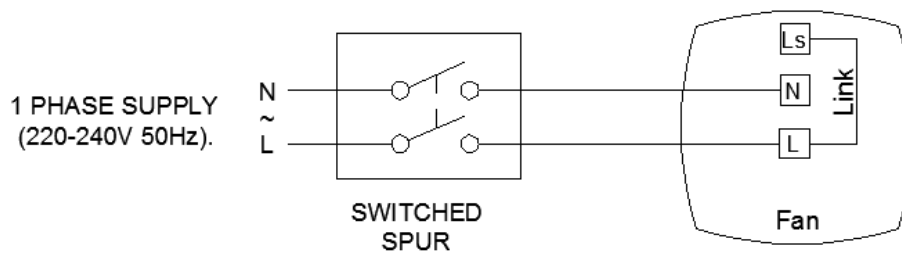

Fig.3. Continuous trickle with boost facility. (The fan is internally fused)

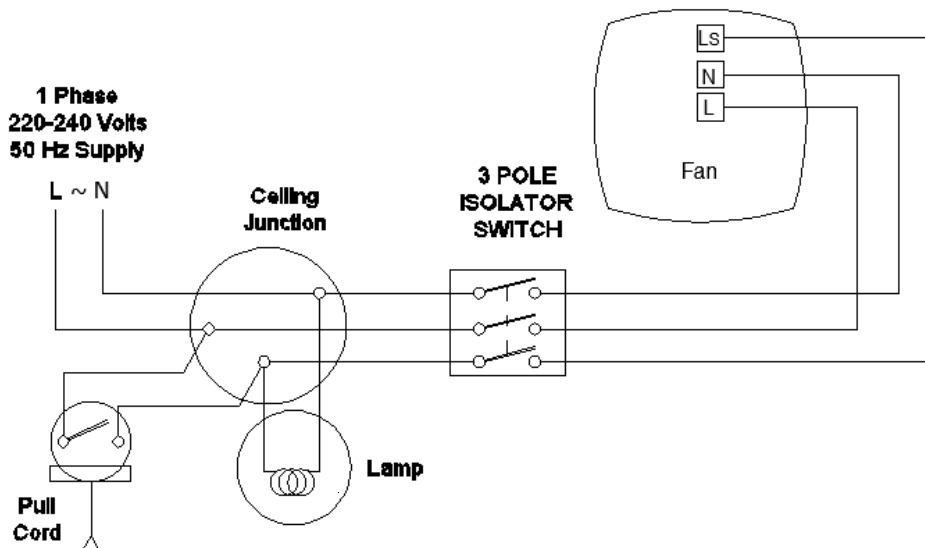
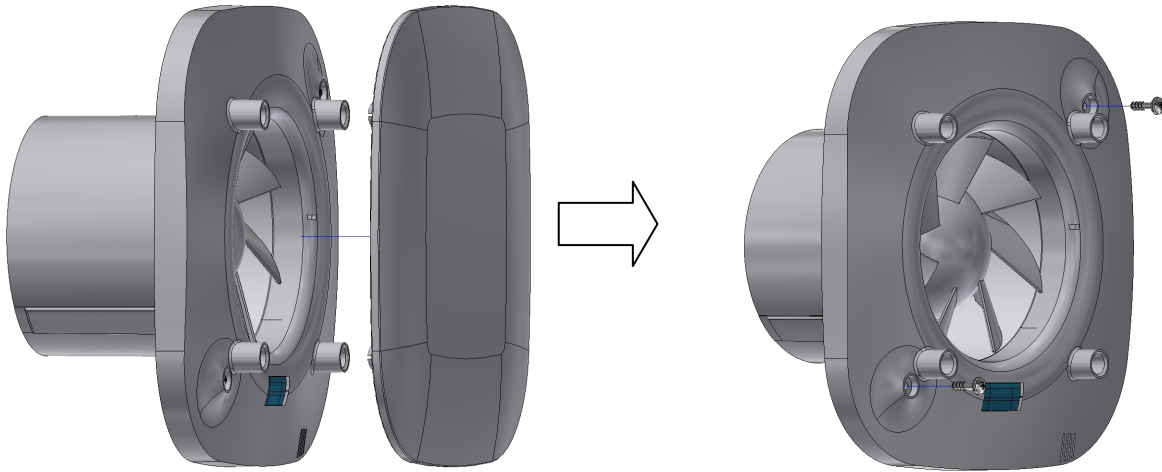
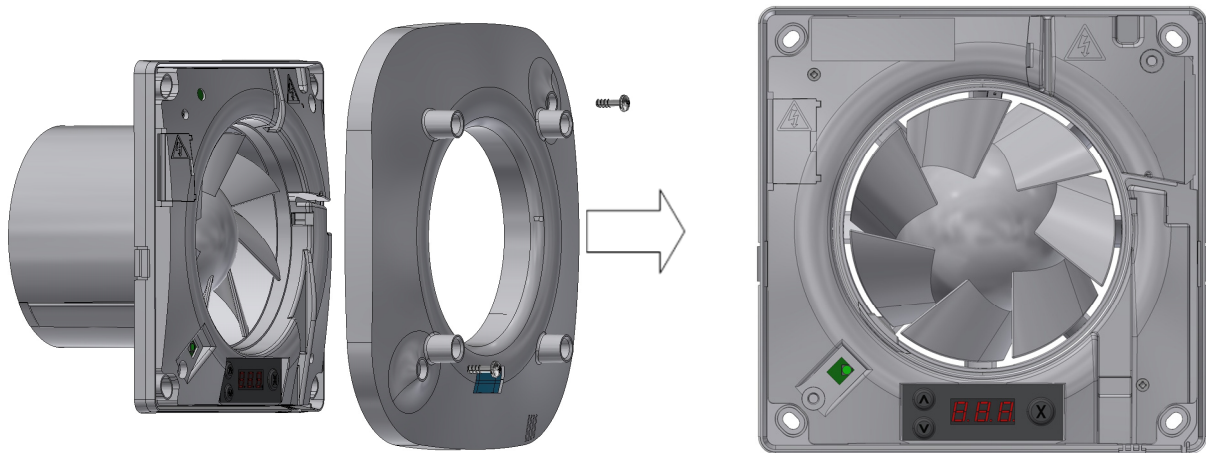

Fig.4 Removing the grille for wiring and setting the controls



Pull front panel as shown.

Loosen screws – DO NOT REMOVE FROM GRILLE (the screws are self-retaining)



Pull inner grille away from housing as shown.

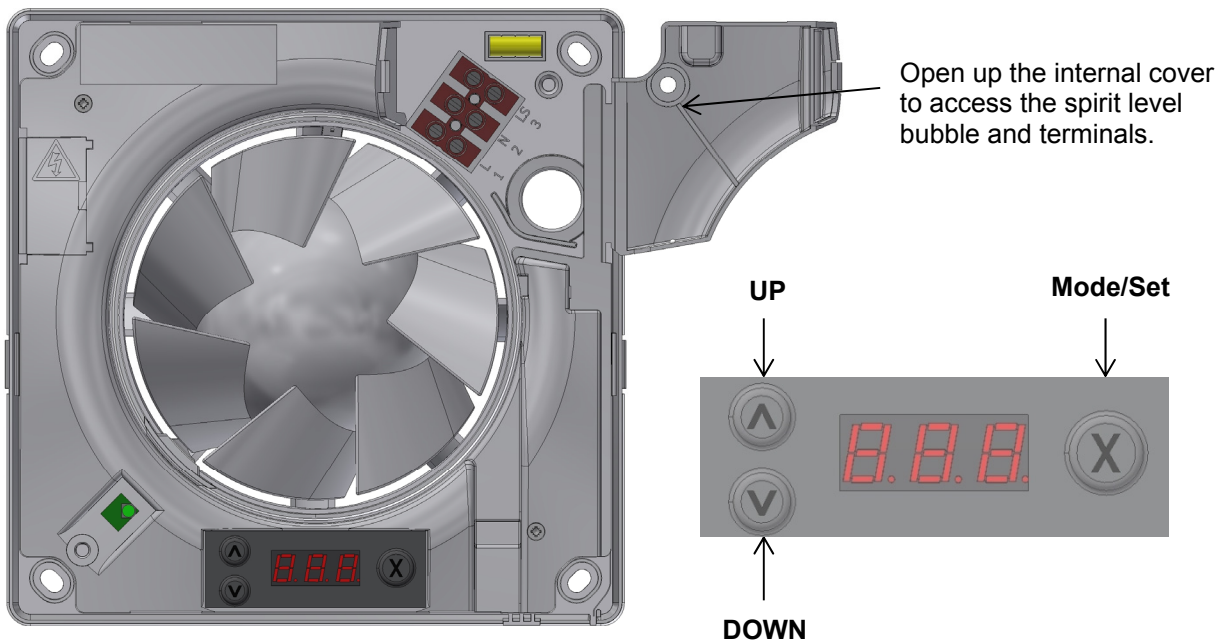

Open up the internal cover to access the spirit level bubble and terminals.

UP

Mode/Set



DOWN

Troubleshooting guide

Problem	Explanation	Solution
Fan speeding up and down	This might be due to external wind conditions	This is normal. If it is a very windy day for example, the fan will be speeding up and down continuously to ensure the correct airflow is maintained.
		If this is a continuous nuisance, change the fan setting from F-2 to F-1 or F-0 dependant on the installation.
Fan moving too much or too little air	Fan set to incorrect speed rate for installation?	Update the speeds to achieve desired airflow.
	This might be due to very windy conditions when the fan was first powered on. Positive or negative pressure on the external wall will influence the initial installation calibration the fan performs.	Reset the fan by updating the F-2 to F-0, power cycle, then back to F-2.
	The fan will react to any equipment used to check the airflow.	Please take into account the product will react to additional pressure from a vane anemometer/other (device that measures airflow), and may run much faster to overcome the resistance. The fan should revert back to the original speed after a few minutes.
Fan displays ERR during calibration	This might be due to very windy conditions when the fan was first powered on. Positive or negative pressure on the external wall will influence the initial installation calibration the fan performs. The fan will still function normally and will try and match the target flow rate as best as possible.	Power cycle the fan when the external wind conditions are better and the fan will retry.

PRODUCT FICHE

For Residential Ventilation Units (Complying Commission Delegated Regulation (EU) No 1254/2014)

Name:	Vent-Axia	Vent-Axia	Vent-Axia	Vent-Axia
Model ID (Stock Ref.) :	NBR DMEV 100HT 473809A	NBR DMEV 100 475142A	NBR DMEV 125HT 494148	NBR DMEV 125 494147
SEC Class	C	E	C	E
SEC Value ('Average')	-25.81	-14.83	-25.81	-14.83
SEC Value ('Warm')	-11.45	-6.22	-11.45	-6.22
SEC Value ('Cold')	-50.90	-29.86	-50.90	-29.86
Label Required? (Yes/No=Out of scope)	No	No	No	No
Declared as: RVU or NRVU/UVU or BVU	RVU-UVU	RVU-UVU	RVU-UVU	RVU-UVU
Speed Drive	Variable Speed	Variable Speed	Variable Speed	Variable Speed
Type HRS (Recuperative, Regenerative, None)	None	None	None	None
Thermal Eff: [(%), NA(if none)]	N/A	N/A	N/A	N/A
Max. Flow Rate (m3/h)	50.04	50.04	135	135
Max. Power Input (W): (@Max.Flow Rate)	1.50	1.50	10	10
LWA: Sound Power Level (dB)	39.52	39.52	54.5	54.5
Ref. Flow Rate (m3/s)	0.01	0.01	0.026	0.026
Ref. Pressure Diff. (Pa)	N/A	N/A	N/A	N/A
SPI [W/(m3/h)]	0.03	0.03	0.03	0.03
Control Factor & Control Typology: (CTRL/ Typology)				
Control Factor; CTRL	0.65	0.95	0.65	0.95
Control Typology	Local Demand Control	Clock Control	Local Demand Control	Clock Control
Declared: -Max Internal & External Leakage Rates(%) for BVUs or carry over (for regenerative heat exchangers only), -&Ext. Leakage Rates (%) for Ducted UVUs;	N/A	N/A	N/A	N/A
Mixing Rate of Non-Ducted BVUs not intended to be equipped with one duct connection on either supply or extract air side;	N/A	N/A	N/A	N/A
Position and description of visual filter warning for RVUs intended for use with filters, including text pointing out the importance of regular filter changes for performance and energy efficiency of the unit	N/A	N/A	N/A	N/A
For UVUs (Instructions Install Regulated Supply/Extract Grilles Façade)	In F&W	In F&W	In F&W	In F&W
Internet Address (for Disassembly Instructions)	www.vent-axia.com	www.vent-axia.com	www.vent-axia.com	www.vent-axia.com
Sensitivity p. Variation@+20/-20 Pa: (for Non-Ducted Vus)	N/A	N/A	N/A	N/A
Air Tightness-ID/OD-(m3/h) (for Non-Ducted Vus)	N/A	N/A	N/A	N/A
Annual Electricity Consumption: AEC (kWh/a)	0.17	0.36	0.17	0.36
Annual Heating Saved: AHS (kWh/a)				
AHS: Average	26.23	15.72	26.23	15.72
AHS: Warm	11.86	7.11	11.86	7.11
AHS: Cold	51.31	30.75	51.31	30.75



Disposal

This product should not be disposed of with household waste. Please recycle where facilities exist. Check with your local authority for recycling advice.

The **Vent-Axia** Guarantee

Applicable only to products installed and used in the United Kingdom. For details of guarantee outside the United Kingdom contact your local supplier.

Vent-Axia guarantees this product for 7 years from date of purchase against faulty material or workmanship. In the event of any part being found to be defective, the product will be repaired, or at the Company's option replaced, without charge, provided that the product:-

- Has been installed and used in accordance with the instructions given with each unit.
- Has not been connected to an unsuitable electricity supply. (The correct electricity supply voltage is shown on the product rating label attached to the unit).
- Has not been subjected to misuse, neglect or damage.
- Has not been modified or repaired by any person not authorised by the company.

IF CLAIMING UNDER TERMS OF GUARANTEE

Please return the complete product, carriage paid to your original supplier or nearest Vent-Axia Centre, by post or personal visit. Please ensure that it is adequately packed and accompanied by a letter clearly marked "Guarantee Claim" stating the nature of the fault and providing evidence of date and source of purchase.

The guarantee is offered to you as an extra benefit, and does not affect your legal rights

Vent-Axia

Head Office: Fleming Way, Crawley, West Sussex, RH10 9YX.

UK NATIONAL CALL CENTRE, Newton Road, Crawley, West Sussex, RH10 9JA

SALES ENQUIRIES: Tel: 0844 856 0590 Fax: 01293 565169

TECHNICAL SUPPORT: Tel: 0344 856 0594 Fax: 01293 532814

For details of the warranty and returns procedure please refer to www.vent-axia.com or write to Vent-Axia Group, Fleming Way, Crawley, RH10 9YX