

## edfc1/3/6

### 1 Phase input - 3 Phase output inverter

#### Installation and Wiring Instructions



Stock Ref.N°

444177

**Vent-Axia®**

PLEASE READ INSTRUCTIONS IN CONJUNCTION WITH ILLUSTRATIONS.  
PLEASE SAVE THESE INSTRUCTIONS

IP54



Software version: D2327A from Version 2.35

## Content

<b>1</b>	<b>General notes</b>	<b>4</b>
1.1	Structure of the operating instructions	4
1.2	Target group	4
1.3	Exclusion of liability	4
1.4	Copyright	4
<b>2</b>	<b>Safety information</b>	<b>4</b>
2.1	Intended use	4
2.2	Explanations of symbols	5
2.3	Product safety	5
2.4	Requirements placed on the personnel / due diligence	5
2.5	Start-up and during operation	5
2.6	Working on device / Hazards through “residual voltage”	6
2.7	Modifications / interventions in the device	6
2.8	Operator’s obligation of diligence	6
2.9	Employment of external personnel	7
<b>3</b>	<b>Product overview</b>	<b>7</b>
3.1	Operational area	7
3.2	Functional description	7
3.3	Maintenance	7
3.4	Transport	7
3.5	Storage	7
3.6	Waste disposal / recycling	7
<b>4</b>	<b>Mounting</b>	<b>8</b>
4.1	General notes	8
4.2	Minimum space requirement	8
4.3	Outdoor installation	8
4.4	Installation location for agriculture	8
4.5	Temperature influences during commissioning	9
<b>5</b>	<b>Electrical installation</b>	<b>9</b>
5.1	Safety precautions	9
5.2	EMC-compatible installation	9
5.2.1	Motor feeder cable	9
5.2.2	Signal cable	9
5.3	Mains connection	9
5.3.1	Line voltage	9
5.3.2	Required quality attributes for the mains voltage	10
5.3.3	Leakage current, securely attached, ground wire double up to 10 mm <sup>2</sup>	10
5.4	Residual-current-operated protective device	10
5.5	Inverter output	10
5.5.1	Motor connection	10
5.5.2	Disconnection between controller and motor (repair switch)	10
5.6	Motor protection	11
5.7	Signal connection or sensor connection to analog inputs (Analog In 1, Analog In 2)	11
5.8	Output voltage 0 - 10 V (Analog Out)	11
5.9	Voltage supply for external devices (+24 V, GND)	11
5.10	Add-on module type Z-Modul-B Part-No. 380052	11
5.11	Digital inputs (D1, D2)	12
5.12	Relay outputs (K1, K2)	12
5.13	Communication	12
5.13.1	Networking via MODBUS-RTU	12

5.13.2	RS-485 - network design and interface parameter	12
5.13.3	LON® Bus system is possible via add-on module	13
5.14	Potential at control voltage connections	13
<b>6</b>	<b>Controls and Menu</b>	<b>14</b>
6.1	Multipurpose LC display and keyboard	14
6.2	Menu operation	14
6.3	Menu structure	15
6.4	Example for programming mode <b>2.01</b> in “Base setup”	15
<b>7</b>	<b>Base setup</b>	<b>16</b>
7.1	Jumper for the input signal	16
7.1.1	External Setpoint / External speed setting in manual operation	16
7.2	Select operation mode	17
<b>8</b>	<b>Start-up</b>	<b>18</b>
8.1	Prerequisites for commissioning	18
8.2	Procedure for commissioning	18
8.3	Menu overview Mode <b>1.01</b> (without add-on modules )	19
<b>9</b>	<b>Programming</b>	<b>19</b>
9.1	Speed controller <b>1.01</b>	19
9.1.1	Base setup <b>1.01</b>	19
9.1.2	Setting for operation <b>1.01</b>	20
9.2	Temperature control <b>2.01...2.05</b>	21
9.2.1	Basic setting <b>2.01... 2.05</b>	21
9.2.2	Settings for operation modes <b>2.01... 2.05</b>	22
9.2.3	Functional diagrams temperature control	23
9.2.4	Additional for mode <b>2.03</b> : Signal output 0 - 10 V	24
9.2.5	For mode <b>2.03</b> : Relay output for Heating or Cooling	25
9.2.6	For mode <b>2.03</b> Relay output for temperature monitoring	26
9.3	Pressure control for condensers refrigeration <b>3.01...3.04</b>	27
9.3.1	Base setup <b>3.01...3.04</b>	27
9.3.2	Setting for operation modes <b>3.01... 3.04</b>	28
9.3.3	Functional diagrams pressure control condensers	29
9.4	Pressure control airconditioning <b>4.01... 4.03</b>	30
9.4.1	Base setup <b>4.01... 4.03</b>	30
9.4.2	Setting for operation modes <b>4.01... 4.03</b>	31
9.5	Volume control <b>5.01...5.02</b>	33
9.5.1	Basic setting <b>5.01</b> and <b>5.02</b>	33
9.5.2	Setting for operation modes <b>5.01...5.02</b>	34
9.6	Air velocity control <b>6.01</b>	36
9.6.1	Base setup <b>6.01</b>	36
9.6.2	Settings for operation modes <b>6.01</b>	37
9.7	Menu group Start	38
9.8	Menu group Info	39
9.9	Controller Setup	40
9.9.1	PIN protection activate, PIN 0010	40
9.9.2	PIN protection activate, PIN 1234	40
9.9.3	Save user settings restore with PIN 9090	40
9.9.4	Sensor Alarm ON / OFF	40
9.9.5	Limit	41
9.9.6	Minimum speed cut off	41
9.9.7	Second Group	42
9.9.8	Reverse action of the control function	42
9.9.9	Controller configuration	43
9.9.10	Data on the total control deviation	43
9.10	IO Setup	44

9.10.1	Analog-Output “A”	44
9.10.2	Digital inputs “D1” / “D2”	45
9.10.2.1	Menu overview	45
9.10.2.2	Enable ON/OFF function <b>1D</b>	46
9.10.2.3	External fault Function <b>2D</b>	46
9.10.2.4	Limit ON / OFF, Function <b>3D</b>	47
9.10.2.5	Switch over Input signal “E1” / “E2”, Function <b>4D</b>	47
9.10.2.6	Set 1/2 or Setpoint 1/2, Function <b>5D</b>	47
9.10.2.7	Intern / Extern Function <b>6D</b>	48
9.10.2.8	Automatic control / speed manual, Function <b>7D</b> (mode <b>2.01</b> )	49
9.10.2.9	Reverse action of control function ( <b>2.01</b> ), Function <b>8D</b>	49
9.10.2.10	Reset, Function <b>10D</b>	49
9.10.2.11	Setting Max. Speed ON / OFF function <b>11D</b>	50
9.10.2.12	Motorheating ON / OFF, Function <b>12D</b>	50
9.10.2.13	Direction of rotation, Function <b>13D</b>	51
9.10.2.14	“Freeze function” = maintain momentary modulation value, Function <b>14D</b>	51
9.10.3	Inverting analog inputs “E1” / “E2”	51
9.10.4	Function and inverting for relay outputs “K1” and “K2”	52
9.10.5	Programming Add-on module type Z-Modul-B	53
9.10.6	Network by MODBUS®	54
9.11	Limits	55
9.11.1	Limit indication depending on modulation	55
9.11.2	Limit indication depending on setting or sensor signal	55
9.11.3	Limit indication depending on (offset) to Setpoint	57
9.12	Motor Setup	58
9.12.1	Setting motor rated current	58
9.12.2	Setting motor rated voltage	58
9.12.3	Adjustment of the U/f curve	58
9.12.4	Setting for Rampup time and Rampdown time	59
9.12.5	Setting Rolling direct.	60
9.12.6	Setting Current limit	60
9.12.7	Setting brake function	61
9.12.8	Setting Boost value	61
9.12.9	Setting Derating Alarm and Temperaturemonitoring	62
9.12.10	Suppression of speeds	62
<b>10</b>	<b>Menu tables</b>	<b>63</b>
10.1	Menus of operating modes	63
10.2	Possible allocation of the IOs, PINs	68
<b>11</b>	<b>Diagnostics menu</b>	<b>70</b>
<b>12</b>	<b>Events / Fault signals</b>	<b>72</b>
12.1	Display and query of events and malfunctions	72
12.2	Messages and trouble shooting	72
<b>13</b>	<b>Function extension and version of software</b>	<b>74</b>
<b>14</b>	<b>Enclosure</b>	<b>75</b>
14.1	Technical data	75
14.1.1	Performance reduction during elevated ambient temperatures	76
14.2	Connection diagram	77
14.3	Dimensions [mm]	77

# 1 General notes

## 1.1 Structure of the operating instructions

**Before installation and start-up, read this manual carefully to ensure correct use!  
We emphasize that these operating instructions apply to specific units only, and are in no way valid for the complete system!**

Use these operating instructions to work safely with and on the device. They contain safety instructions that must be complied with as well as information that is required for failure-free operation of the device.

Keep these operating instructions together with the device. It must be ensured that all persons that are to work on the device can refer to the operating instructions at any time.

Keep the operating instructions for continued use. They must be passed-on to all successive owners, users and final customers.

## 1.2 Target group

The operating instructions address persons entrusted with planning, installation, commissioning and maintenance and servicing and who have the corresponding qualifications and skills for their job.

## 1.3 Exclusion of liability

Concurrence between the contents of these operating instructions and the described hardware and software in the device has been examined. It is still possible that non-compliances exist; no guarantee is assumed for complete conformity. To allow for future developments, construction methods and technical data given are subject to alteration. We do not accept any liability for possible errors or omissions in the information contained in data, illustrations or drawings provided.

We accept no liability for damage caused by misuse, incorrect use, improper use or as a consequence of unauthorized repairs or modifications.

## 1.4 Copyright

These operating instructions contain copyright protected information. The operating instructions may be neither completely nor partially photocopied, reproduced, translated or put on data medium without previous explicit consent. Infringements are liable for damages. All rights reserved, including those that arise through patent issue or registration on a utility model.

# 2 Safety information

This chapter contains instructions to prevent personal injury and property damage. These instructions do not lay claim to completeness. In case of questions and problems, please consult our company technicians.



## 2.1 Intended use

The equipment is to be used solely for the purposes specified and confirmed in the order. Other uses which do not coincide with, or which exceed those specified will be deemed unauthorised unless contractually agreed. Damages resulting from such unauthorised uses will not be the liability of the manufacturer. The user will assume sole liability.

Reading these operating instructions and complying with all contained instructions – especially the safety notifications contained therein – are considered part of intended use. To consider is also the manual of attached components. Not the manufacturer, rather the operator of the device is liable for any personal harm or material damage arising from non-intended use!

## 2.2 Explanations of symbols

Safety instructions are highlighted with warning triangles and are depicted according to the degree of hazard as follows.

	<p><b>Attention!</b> Hazardous area. Death or severe injury or significant property damage can occur if the corresponding precautions are not taken!</p>
	<p><b>Danger owing to electric current</b> Danger owing to electric current or voltage.</p>
	<p><b>Information</b> Important information and advice for user.</p>

## 2.3 Product safety

The device conforms to the state of the art at the time of delivery and is fundamentally considered to be reliable. The device and its accessories must only be used in a flawless condition and installed and operated in compliance with the assembly instructions and/or operating instructions. Operating outside the device's technical specifications (→ rating plate and attachment / technical data) can lead to a defect in the device and additional damage!

**In the case of a malfunction or a failure of the equipment check all functions with alarms in order to prevent injury to persons or property. Note possibility of back-up operation. If used in intensive animal environments, any malfunctions in the air supply must be detected as soon as possible to prevent the development of a life-threatening situation for the animals. The design and installation of the system must comply with local regulations and directives. In Germany these include DIN VDE 0100, the animal protection and the keeping of working animals ordinance and the pig-keeping ordinance etc. Also note the instructions of AEL, DLG, VdS.**

## 2.4 Requirements placed on the personnel / due diligence

Persons entrusted with the planning, installation, commissioning and maintenance and servicing in connection with the frequency inverter must have the corresponding qualifications and skills for these jobs.

In addition, they must be knowledgeable about the safety regulations, EU directives, rules for the prevention of accidents and the corresponding national as well as regional and in-house regulations. Personnel to be trained or instructed and apprentices are only permitted to work on the device under the supervision of an experienced person. This also applies to personnel undergoing general training. Comply with the legal minimum age.

This device is not intended to be used by people (including children) who have restricted mental, sensory or intellectual abilities or who have a lack of experience and/or knowledge.

## 2.5 Start-up and during operation



### Attention!

During commissioning, unexpected and hazardous conditions can arise in the entire installation due to defective adjustments, defective components or incorrect electrical connections. Remove all persons and objects from the hazardous area.

During operation, the device must be closed or installed in a control cabinet. Fuses may only be replaced by new ones and must not be repaired or bypassed. The data for the maximum line fuse are to be considered absolutely (→ Technical data). Use only fuses specified in schematic diagrams. Any faults detected in the electric system/modules/operating equipment must be corrected immediately. If these faults are not corrected, the device/system is potentially very dangerous. The device/system must therefore not be operated when it is faulty.

## 2.6 Working on device / Hazards through “residual voltage”



### Information

Installation, electrical connection, and start-up operation may only be carried out by an electrical specialist in accordance with electrotechnical regulations (e.g. DIN EN 50110 or DIN EN 60204)!



### Danger owing to electric current

It is forbidden to carry out work on electrically live parts. Protection class of the device when open is IP 00! It is possible to inadvertently touch components carrying hazardous voltages.

The safe isolation from the supply must be checked using a **two-pole** voltage detector.



### Waiting period at least 3 minutes!

Through use of capacitors, danger of death exists even after switching off the device through directly touching the energized parts or due to parts that have become energized due to faults. It is only permitted to remove the housing cover after waiting for 3 minutes once the line supply cable has been shut down. Should measurement or adjustment work be unavoidable on the opened unit while still powered, then this may only be performed by qualified personnel acquainted with the thereby associated hazards.



### Danger owing to electric current

- Even after disconnecting the mains voltage, life-threatening charges can appear between the protective ground “PE” and the mains connection.
- The protective conductor is routed over high discharge currents (irrespective of the clock frequency, current-source voltage and motor capacity). Earthing in compliance with VDE specifications shall therefore be observed even for testing and trial conditions (EN 50 178, Art. 5.2.11). Without earthing, dangerous voltages can be present on the motor housing.



### Attention!

**Automatically restart after a power failure or mains disconnection!**

## 2.7 Modifications / interventions in the device



### Attention!

For reasons of safety, no unauthorized interventions or modifications may be made on the device. All planned modifications must be authorized by the manufacturer in writing.

Only use the manufacturer’s original spare parts / wearing parts / accessories. These parts are specially designed for this device. If parts from other sources are used, there is no guarantee that they are designed and produced for the proper loads and with the required level of safety. Parts and special equipment not supplied by the manufacturer are not approved for use.

## 2.8 Operator’s obligation of diligence

- The contractor or owner must also ensure that the electric systems and equipment are operated and maintained in accordance with electro-technical regulations.
- The owner is obliged to ensure that the device are operated in perfect working order only.
- The device may only be used as intended (☞ “Application”).
- You must periodically examine the safety equipment for their properly functioning condition.
- The assembly instructions and/or operating instructions are always readily available at the location where the device is being used, are complete and are in legible condition.
- These persons are regularly instructed in all applicable questions regarding occupational safety and environmental protection and are knowledgeable regarding the assembly instructions and/or operating instructions and, especially, are familiar with the safety instructions contained therein.
- All safety and warning notices attached to the frequency inverter are never removed and remain legible.

## 2.9 Employment of external personnel

Maintenance and service work are frequently carried out by external employees who often do not recognize the specific situations and the thus resulting dangers. These persons must be comprehensively informed about the hazards in their area of activity.

You must monitor their working methods in order to intervene in good time if necessary.

## 3 Product overview

### 3.1 Operational area

The frequency inverter is designed for a stepless control of fans without additional (electromagnetic) motor noise.

### 3.2 Functional description

Frequency inverters of these series generate their 3 ~ output with variable voltage and frequency from the 1 ~ AC mains network on the input.

These are structured corresponding to the general requirements in DIN EN 61800-2 for adjustable speed electrical power systems and are designed for single-quadrant operation.

The PFC (Power Factor Controller) makes the output voltage mostly independent of the mains voltage.

**By using the integrated all-pole effective Sine filter (phase to phase and phase to ground), an absolute parallel control of fans without risk of damage for motors is possible. Screened motor cables are not required!**

### 3.3 Maintenance

The device must be checked for soiling and, if necessary, cleaned in periodic intervals.

### 3.4 Transport

- The device is packed ex factory to suit the transport method previously agreed.
- Always use the original packaging materials when transporting the device.
- Avoid shocks and impacts to the device during the transport.
- During manual handling the human lifting and carrying restrictions must be observed and adhered to.

### 3.5 Storage

- The device must be stored in its original packaging in a dry and weather-proof room.
- Avoid exposure to extreme heat and cold.
- Avoid prolonged storage; we recommend a maximum of one year (consult the manufacturer before starting if stored for longer).

### 3.6 Waste disposal / recycling

Disposal must be carried out professionally and environmentally friendly in accordance with the legal stipulations.



## 4 Mounting

### 4.1 General notes



#### Attention!

The following points must be complied with during the mechanical installation to avoid causing a defect in the device due to assembly errors or environmental influences:

- Before installation remove the device from the packing and check for any possible shipping damage!
- Assemble the device on a clean and stable base. Do not distort during assembly! Use the appropriate mounting devices for proper installation of the unit!
- When mounted onto lightweight walls, there must be no impermissibly high vibrations or shock loads. Any banging shut of doors that are integrated into these lightweight walls, can result in extremely high shock loads. Therefore, we advise you to decouple the devices from the wall.
- Do not allow drilling chips, screws and other foreign bodies to reach the device interior!
- Maintain the stated minimum clearances to ensure unobstructed cooling- air feed as well as unobstructed outgoing air discharge (☞ minimum space requirement)!
- The plastic washers must be installed between the screw heads and the housing for models with mounting holes on the inside of the housing!
- The device should be installed in a location where it will not be disturbed, but at the same time can be easily accessed!
- Depending on the housing model cut off necessary cable inlets respectively to the cable diameter. Or alternative use cable inlet for cable glands. Metal sheet housings are supplied with stoppers. Any cable ducts openings not used must be sealed!
- Care must be taken to avoid direct radiation from the sun!
- The device is designed for vertical installation (cable inlet down). A horizontal or reclined installation is only permissible after technical release of the manufacturer!
- Be sure to observe proper heat dissipation (☞ Technical data, heat dissipation).

### 4.2 Minimum space requirement

In order to ensure sufficient ventilation of the device, clearance on all sides of at least 50 mm has to be maintained to the housing walls, switch cabinet doors, wiring ducts, etc. The same clearance applies to the installation of several devices next to each other.

When installing several devices on top of each other, the danger of reciprocal heating exists. This layout is only then permissible when the air suctioned from the upper unit does not become warmer than the permissible ambient temperature (☞ Technical data). I.e., a correspondingly larger clearance or thermal shielding is required.

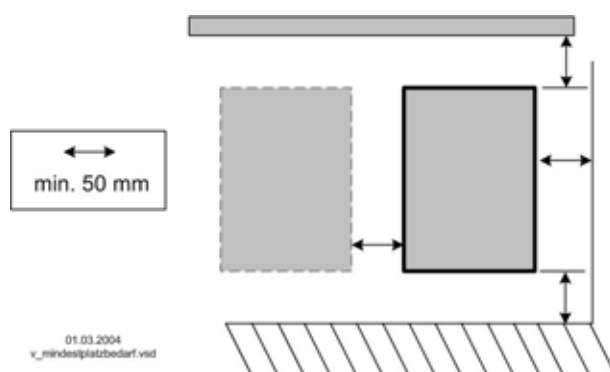

### 4.3 Outdoor installation

Outdoor installation is possible up to  $-20^{\circ}\text{C}$  when the controller supply is not switched off. Installation must be protected from the effects of weather as much as possible, including protection from direct sunlight!

### 4.4 Installation location for agriculture

In order to avoid damage caused by ammoniac vapours, the controller shall not be installed in the stable, but rather in an outhouse wherever possible.

#### 4.5 Temperature influences during commissioning

Avoid condensation in the controller and hence functional faults attributable to condensation by storing the controller at room temperature!

## 5 Electrical installation

### 5.1 Safety precautions



#### Danger owing to electric current

- Work on electric components may only be carried out by trained electricians or by persons instructed in electricity under the supervision of an electrician in accordance with electrical engineering regulations.
- It is forbidden to carry out work on electrically live parts. Even after disconnection, the dc-link is still live. Always wait at least 3 minutes.
- A second person must always be present when working on energized parts or lines who disconnects in case of emergency.
- Inspect electrical equipment periodically: retighten loose connections – immediately replace damaged lines and cables.
- Always keep switch cabinets and all electrical supply facilities locked. Access is only allowed for authorized persons using a key or special tool.
- Operating the device with the housing cover removed is prohibited because energized, exposed parts are present inside the device. Disregarding this regulation can lead to severe personal injury.
- The required protective earth connection is established using screws between the housing parts in metal terminal space covers and housing casings. Commissioning is only permissible after these screws have been properly attached!
- Metal screwed-connections are not permitted in plastic housing parts because there is no potential equalization.
- Never clean electrical equipment with water or similar liquids.



#### Information

The respective connections are represented in the enclosure of this manual (☞ Connection diagram)!

### 5.2 EMC-compatible installation

#### 5.2.1 Motor feeder cable

The applicable standard for interference emissions is EN 61000-6-3. Compliance with this standard is achieved through the use of an unscreened motor feed cable.

#### 5.2.2 Signal cable

Pay attention to sufficient distance from powerlines and motor wires to prevent interferences. The control cable may not be longer than 30 m. Screened control cables must be used when the cable length is longer than 20 m. When using a shielded cable connect the shielding to one side only, i.e. only to the control unit with the protective ground (keep cable short and with as little inductance as possible!).

### 5.3 Mains connection

#### 5.3.1 Line voltage

Power from the mains is connected to terminals: PE, L1 and N. Here, it must be strictly observed that the mains voltage lies within the allowable tolerance specifications (☞ Technical data and nameplate affixed to the side).

A connection between two phase conductors is possible for 3 ~ 230 V supply networks.



#### Information

**During disconnection of the line voltage the necessary waiting period before renewed switching on amounts minimum 90 seconds!**

### 5.3.2 Required quality attributes for the mains voltage



#### Danger owing to electric current

The mains voltage must comply with the DIN EN 50160 quality characteristics and the defined standard voltages in IEC 60038!

### 5.3.3 Leakage current, securely attached, ground wire double up to 10 mm<sup>2</sup>



#### Danger owing to electric current

In accordance with the defined networks in DIN EN 60990, the device has a leakage current > 3.5 mA so it must be permanently connected. The protective ground must be made double in accordance with EN 50178 Point 5.2.11 and 5.3.2.1 up to a cross section of at least 10 mm<sup>2</sup>.

### 5.4 Residual-current-operated protective device



#### Danger owing to electric current

To ensure as high a degree of reliability as possible we recommend a release current of 300 mA, where a residual current circuit breaker (type A) is used.



Residual current circuit breaker (type A)

**Exception:** for mains connection between two phase conductors of supply networks 3 ~ 230 V

For an installation of r.c.d. protection, it shall be observed that this must be of “universal current sensitivity”. In accordance with EN 50 178, Section. 5.2. other types of current-operated protective devices may not be used.

### 5.5 Inverter output

#### 5.5.1 Motor connection



#### Information

Frequency inverters of these series generate their 3 ~ output with variable voltage and frequency from the 1 ~ AC mains network on the input.

A three-phase motor with a **230 V / 400 V** voltage rating is connected during direct connection to a 3 ~ 400 V line in star formation, when connecting to an **inverter output (3 ~ 230 V) in delta connection**. Direct operation (Bypass) of the three-phase current motor on a 1~ network is not possible.

The motor leads are connected to the terminals: PE, U, V, W. Several fans can be connected to the controller-the maximum total current of all motors must not exceed the current rating for the controller.



#### Information

- It is recommended that a separate motor protection unit be foreseen for each fan.
- For motors with thermistors “TP” (PTC thermistor) e.g. type U-EK230E
- For motors with thermostats “TB” (thermal contacts) e.g. type STDT16 or AWE-SK

#### 5.5.2 Disconnection between controller and motor (repair switch)

Ideally, a repair switch should be installed **before the controller** (supply line disconnect).

In the case of complete disconnection (entire load) after the controller, the enable (controller OFF / ON) must be disconnected simultaneously. I.e., an additional control contact is needed. Switching on the motor while simultaneously issuing the enable (ON) achieves secure energizing with low saturation of the controller. For this a programming is necessary (☞ IO Setup Enable ON / OFF).



#### Attention!

When switching on the motor plus existing release: under certain circumstances, this can occur under full modulation of the controller.

## 5.6 Motor protection

Motor protection is possible by connecting thermostats “TB” (thermal contacts) or thermistors “TP” (PTC).

- When several motors are connected ensure that the thermal contacts “TB” or PTC resistors “TP” are always connected in series. A maximum of six individual thermistors (DIN 44081 or DIN 44082) may be connected in series to a single device. Depending on the motor type, at least two or three individual sensors are built in.
- Monitoring of motors in Ex zones is not permissible. For systems of this type, an additional posistor tripping unit is required, with disconnection via a separate motor protection circuit.

The unit switches off when a connected thermostat or thermistor has tripped the circuit (interruption between both terminals “TB/TP” or “TK/PTC”). The unit then remains switched off. A programmed fault-indicating relay is triggering.



Display during motor fault

**Possibilities for re-starting after the drive has cooled down terminals “TB/TP” or “TK/PTC” by:**

- By switching the mains voltage off and then on again.
- By simultaneously depressing the three keys: **P**, **▲**, **▼** (if a fault is indicated).
- By digital input for remote (enable ON/OFF) or by Reset-input (☞ IO Setup - Digital Inputs).



### Attention!

- **An outside voltage may never be connected to the terminals “TB/TP” and/or “TK/PTC”!**
- If a bypass circuit is installed, or in the “100%” position on devices with a main switch, the motor protection inside the controller has no function. In this case, additional motor monitoring may be required.

## 5.7 Signal connection or sensor connection to analog inputs (Analog In 1, Analog In 2)

The unit has 2-analog inputs:

- E1 Analog In = terminals “E1” / “GND” (Analog In 1)
- E2 Analog In = terminals “E2” / “GND” (Analog In 2)

Ensure correct polarity when connecting; a 24 V DC power supply is integrated for sensors. For sensors in two-wire-technology (4 - 20 mA signal), the connection is made on the “+24 V” and “E1” or “E2” terminals (the GND terminal is omitted). The connection is independent of the programmed mode and from the sensor signal employed. Place the internal jumper for the external default signal in the correct position. Factory setting 0 - 10 V (☞ Jumper for Input signal).



### Attention!

**Never apply line voltage to analog inputs!**

## 5.8 Output voltage 0 - 10 V (Analog Out)

The analog outputs 0 - 10 V can be allocated with various functions (☞ IO Setup: Analog output “A”). Connection to terminal “A” - “GND” = “Analog Out” ( $I_{max}$  10 mA).

It is not permissible to connect outputs of several devices to each other!

## 5.9 Voltage supply for external devices (+24 V, GND)

A voltage supply is integrated for external devices, e.g., for a sensor. “+24 V” Output voltage tolerance +/- 20 %. Max. load current 120 mA (for connection to an external “AXG..” terminal minus approx. 50 mA).

It is not permissible to connect outputs of several devices to each other!

During an overload or short-circuit (24 V - GND), the control voltage (and thus the device) is disconnected. Automatic start after elimination of the cause of error.

## 5.10 Add-on module type Z-Modul-B Part-No. 380052

The expansion module can be retrofitted. This could be necessary if the analog and digital inputs and outputs are not sufficient for certain applications. The board is easy to install into the device and is connected with the control device via a plug. Program the additional inputs and outputs in “IO Setup”.



- 1x analogue input 0-10 V ( $R_i > 100\text{ k}\Omega$ ) for external Set point
- 1x output 0 - 10 V ( $I_{\text{max}} 10\text{ mA}$ )
- 3x digital-inputs, Activation via floating contacts
- 2x relay outputs (contact load 5 A 250 V AC)

Add-on module type Z-Modul-B

### 5.11 Digital inputs (D1, D2)

Various functions can be allocated to the digital inputs “D1” and “D2” (☞ IO Setup: Functions summary of the digital inputs). Activation via floating contacts (a low voltage of ca. 24 V DC is connected).



#### Attention!

Never apply line voltage to the digital input!  
It is not permissible to connect inputs of several devices to each other!

### 5.12 Relay outputs (K1, K2)

Various functions can be allocated to the relay outputs “K1” and “K2” (☞ IO Setup: function and inverting relays outputs). Max. contact rating ☞ technical data and connection diagram. Connection of the floating contacts of relay “K1” to the terminals 11, 14, 12. Connection of the floating contacts of relay “K2” to the terminals 21, 24, 22.

### 5.13 Communication

#### 5.13.1 Networking via MODBUS-RTU

The device comes equipped with a RS-485 interface for networking via a MODBUS. Connection to terminals “D+”, “D-”, and “GND”.

**A maximum of 64 members can be directly connected to one another, and another 63 members via a repeater.**

**The address must be set in the “IO Setup” menu.**

#### 5.13.2 RS-485 - network design and interface parameter

You must ensure correct connection; i.e. "D+" must also be connected on the following devices to "D+". The same applies to "D-".

In addition, a "GND" connection must be established, as dissimilar potential (over 10 V!) will lead to the destruction of the RS-485 interface (e.g. lightning).

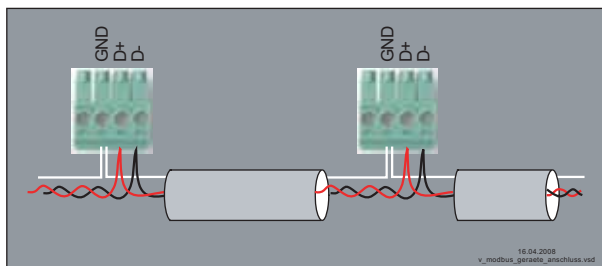

general example for Modbus device connection

The data line must be conducted from one device to the next. No other type of wiring is allowed!  
Always use only two wires of one lead (twisted pair) for the connection.

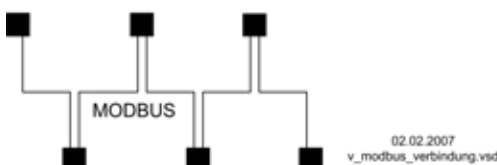

Examples for Modbus connection

**Recommended wire types**

1. CAT5 / CAT7 cables
2. J-Y (St) 2x2x0.6 (telephone wire)
3. AWG22 (2x2 twisted pair)

When using telephone flex with four cable cores, we recommend the following allocation:  
 "D+" = red, "D-" = black, "GND" = white

**Information**

- Pay attention to sufficient distance from powerlines and motor wires (min. 20 cm)
- Do not use wire shield
- Except the data link " D+" , " D-" and " GND" - connection may no further cable cores of the data line be used.
- Max. allowed wire length 1000 m (CAT5/7 500 m)

**Default interface parameter**

Baud rate	=	19200
Bits	=	8
Parity	=	Even (None, exception of devices agriculture)
Stop bits	=	1
Handshake	=	none

**5.13.3 LON® Bus system is possible via add-on module**

Connection to the LON® bus system is possible via add-on module type "Z-Modul-L" (Part-No. 380053). Communication to controller via the RS-485 interface, FTT-10A transceiver.

**5.14 Potential at control voltage connections**

The control voltage connections (< 50 V) relate to the joint GND potential (Exception: Relay contacts are potential free). There is a potential separation between the control voltage connections and the earthed conductor. It must be ensured that the maximum external voltage at the control voltage connections cannot exceed 50V (between "GND" terminals and "PE" earthed conductor). If necessary, a connection to the earthed conductor potential can be established, install bridge between "GND" terminal and the "PE" connection (terminal for screening).

## 6 Controls and Menu

### 6.1 Multipurpose LC display and keyboard

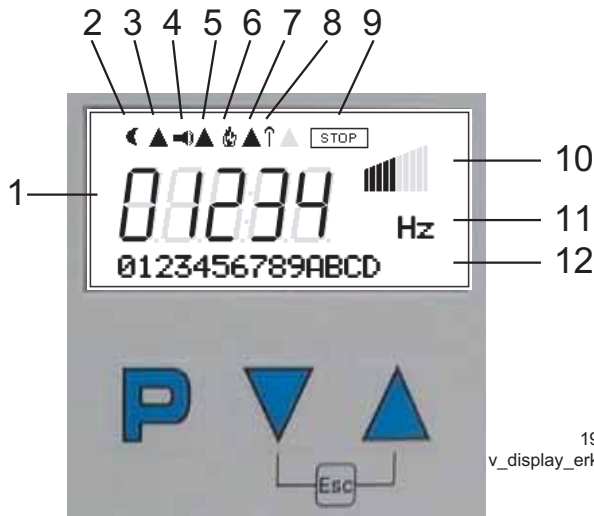

19.05.2009  
v\_display\_erklaerung\_fcontrol.vsd

1. Numeric display 5 digit
2. Moon-Symbol for set point 2
3. Current derating active
4. Alarm-Symbol (fault indication)
5. Brake motor or motor heating active
6. Fire-Symbol (heating operation)
7. Derating (power reduction active)
8. External switch over direction of rotation active
9. STOP-Symbol (enable)
10. Bargraph Fanlevel
11. Text line 3 figures (display unit, etc.)
12. Text line 16 figures (display text menu.)

- P** Program key and open menu
- ▼** Menu selection, reduce value
- ▲** Menu selection, increase value
- ▼+▲** ESC-key combination, Escape = leave menu

### 6.2 Menu operation

**Display after turning on the mains voltage.**  
description for menu language English = "GB" (delivery status).  
Switch over between "Start" and \*Actual value with Escape **[Esc]**.

Example for mode **1.01** (speed controller).

\*actual value depending device type:  
- Speed / rpm,- Frequency / Hz, - Fanlevel / %

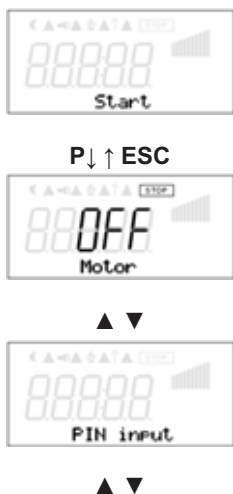

By pushing the **P** key one reaches the menu item "START".

**P** ↓ ↑ **ESC**

Motor OFF / ON

▲ ▼

One moves up and down within the menu group using the arrow keys.

▲ ▼



In the menu point “Language” display language can be selected.  
 One returns to the menu group “Start” using the ESC (▼ + ▲) shortcut keys.

### 6.3 Menu structure

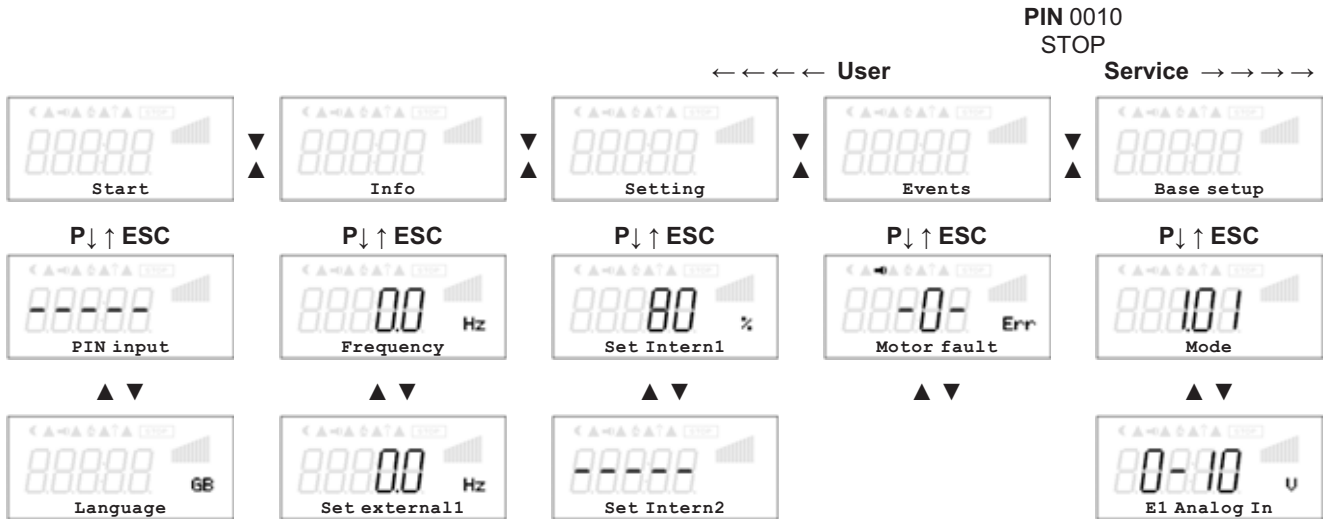

Menu dependent on device type

Selection of the menu group (e.g. Base setup) to the right through the ▼-key, to the left through the ▲-key.  
 You can go to the menu items in the menu groups (e.g. mode of operation) by using the P key. Use the arrow keys to move up and down within the menu group.  
 The menu groups consist of one area for the user (user menu) and one area for installation (service). The service area can be protected against unauthorized access by using a PIN.  
 In order to simplify the initial start-up operation, the service level is enabled at first (i.e., not protected by the PIN 0010 (see Controller Setup, PIN protection = OFF)). If PIN protection is activated (ON), the service menu remains enabled after input of PIN 0010 as long as one is pressing keys. If no keys are pressed for ca. 15 minutes, the PIN is automatically erased, i.e. the service level is blocked.  
 To make adjustments, press the P key after selecting the menu item. If the previously set value starts to flash, it can be adjusted with the ▼ + ▲ keys and then saved with the P key. To exit the menu without making any changes, use the “Esc” short-key, i.e., the originally set values remain.



#### Information

After installation of the device has been carried out, PIN protection should be activated (see Controller Setup)!

### 6.4 Example for programming mode 2.01 in “Base setup”

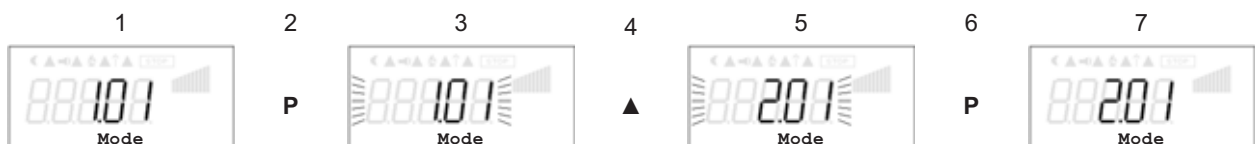



## 7 Base setup

### 7.1 Jumper for the input signal

**Jumper position factory setting for 0 - 10 V signal. For temperature sensors (TF..) or sensors with 4 - 20 mA bring the internal jumper for the external signal in the correct position. Caution- not under voltage! Observe the safety notices! When using “other sensors” bring the jumper in the correct position. The adjustment of the measuring range takes place in the Base setup of respective Mode.**

#### E1 Analog In (factory setting 0 - 10 V)

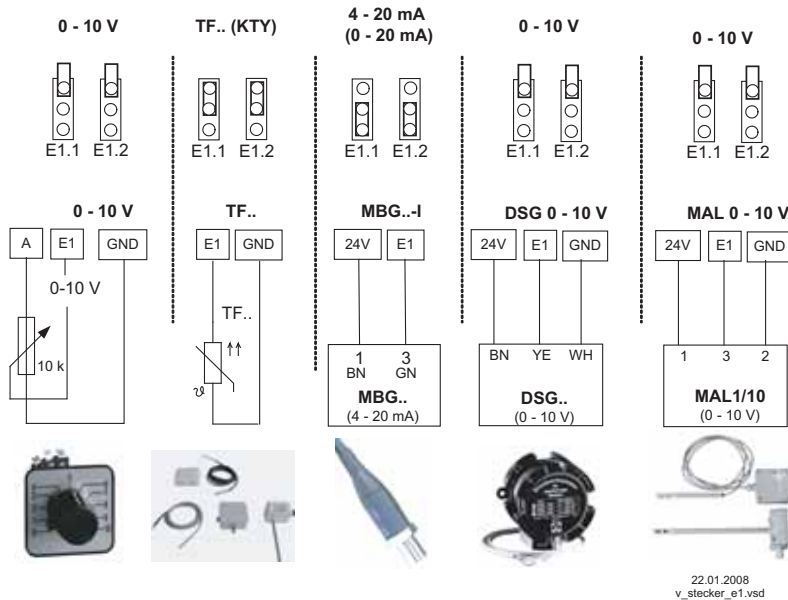

#### E2 Analog In for modes with two sensors

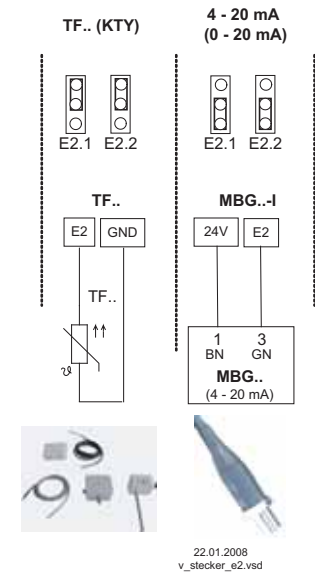

#### 7.1.1 External Setpoint / External speed setting in manual operation

External Setpoint or external manual operation is possible by 0-10 V (0-20 mA, 4-20 mA) Signal at terminals “E2” and “GND”. Place internal Jumper “E2.1” and “E2.2” for “E2 Analog In” in correct position. “E2” Configuration in base setup. For Potentiometer AnalogOut1 (terminal “A”) program to function **[1A]** = “+10 V” (like factory setting IO Setup). If a second sensor is connected at input 2, external Setpoint or speed setting in manual operation is possible with additional modul “Z-Modul-B” (input E3 IO Setup).

E2 Analog In = factory setting 0 - 10 V

E2 Analog In = 0 - 20 mA / 4 - 20 mA

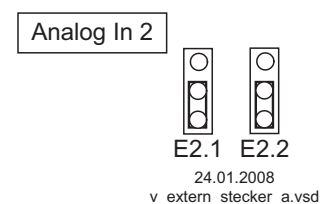
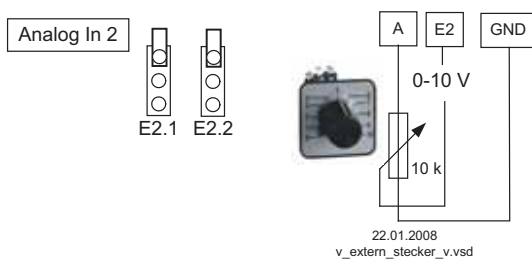

**External Setpoint** via external signal instead of “Setpoint 1”. The “external Setpoint” function must be activated in base setup **[1E]** for “E2 function”. The active external Setpoint value is displayed in the “info” menu group.

**External speed setting** in manual operation. The “external manual operation” function must be activated in the basic settings **[2E]** for “E2 function”. Switchover between settings on the device and external manual operation via the digital input ( IO Setup: “Control / manual operation” **[7D]**).

## 7.2 Select operation mode



### Information

Simple installation is possible through the selection of the preprogrammed mode of operation. This determines the basic function of the device; factory setting **1.01** = speed controller (activation via 0 - 10 V signal). The controller configuration is automatically carried out during selection of the application related mode of operation. The factory presets in accordance with the mode of operation are based on many years of experience, which is suitable for many applications. Under special circumstances, these can be individually adapted (☞ Controller Setup: “Controller Configuration”).

The purpose of the device is to reach and maintain the target values set. To accomplish this, the measured actual value (sensor value) is compared with the adjusted target value, and the controlled value (modulation) is deduced from this.

Mode	Signal or Sensor (input)	Function
<b>1.01</b>	Signal 0 - 10 V	Speed controller, two step operation (factory setting)
<b>2.01</b>	Sensor TF..(E1)	Temperature control airconditioning and refrigeration. (preset set-point 20.0 °C, P-band 5.0 K)
<b>2.02</b>	Sensor TF..(E2)	Temperature control depending on outdoor temperature (preset set-point 5.0 °C, - P-band 20.0 K)
<b>2.03</b>	Sensor TF..(E1)	Temperature control with additional functions (heating, shutter, temp. monitoring)
<b>2.04</b>	1x Sensor TF..(E1) 1x Sensor TF..(E2)	Temperature control with two sensors, comparison or average
<b>2.05</b>	1x Sensor TF..(E1) 1x Sensor TF..(E2)	Temperature control with two sensors differential temperature
<b>3.01</b>	Sensor MBG.. (E1)	Pressure control condensers (refrigeration)
<b>3.02</b>	Sensor MBG..(E1)	Pressure control for condensers with input for refrigerant
<b>3.03</b>	1x Sensor MBG..(E1) 1x Sensor MBG..(E2)	Pressure control for two circuit condensers
<b>3.04</b>	1x Sensor MBG..(E1) 1x Sensor MBG..(E2)	Pressure control for two circuit condensers with input for refrigerant
<b>4.01</b>	Sensor DSG..(E1)	Pressure control for ventilation systems
<b>4.02</b>	1x Sensor DSG..(E1) 1x Sensor TF..(E2)	Pressure control depending on outdoor temperature
<b>4.03</b>	1x Sensor DSG..(E1) 1x BUS RS 485	Pressure control depending on outdoor temperature, MODBUS for outdoor temperature and remote control by central operating device type AXE-200
<b>5.01</b>	Sensor DSG..(E1)	Volume control (constant) for ventilation systems
<b>5.02</b>	1x Sensor DSG..(E1) 1x Sensor TF..(E2)	Volume control with setpoint depending on outdoor temperature
<b>6.01</b>	Sensor MAL..(E1)	Air velocity control e.g. clean room

## 8 Start-up





### 8.1 Prerequisites for commissioning

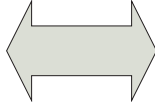

**Attention!**

1. You must mount and connect the device in accordance with the operating instructions.
2. Check all connections for correctness once more.
3. The mains voltage must match the information on the rating plate.
4. The rated current on the rating plate will not be exceeded.
5. Make sure that no persons or objects are in the fan's hazardous area.

### 8.2 Procedure for commissioning

Sequence	Setting
1	Check if Thermostats or Thermistors of the motor are connected to input "TB/TP In". If the motor protection function of the device is not necessary the both terminals "TB / TP" have to be bridged.
2	Check connection and close housing carefully.
3	Turn on mains voltage. <div style="display: flex; align-items: center; justify-content: center; gap: 20px;">    </div> <p style="text-align: center;">Display after first turning on the mains voltage.</p>
4	In menu group <b>Start</b> the adjustment for <b>Motor</b> is "OFF" for factory setting. This prevents the system from inadvertently starting up before configuration is complete. Operation of the device after pressing the "Esc" hotkey combination. Settings for U/f characteristic can only be made when no motor modulation is present! This is the same also for the setting of Mode. <div style="display: flex; align-items: center; justify-content: center; gap: 20px;">  <div style="text-align: center;"> <p>Switch-over between "OFF" and "Start" with the key shortcut for Escape ((Esc = ▼ + ▲).</p> </div>  </div>
5	If necessary, set the menu language in Menu group <b>Start</b> . (Factory setting Englisch: " <b>Language GB</b> ")
6	Set the operating mode in the <b>Base setup</b> menu group (factory settings <b>1.01</b> = <b>speed controllers</b> ). <b>Attention!</b> When saving the operating mode, the respective preset factory operating-mode setting is loaded. That means, the settings you have made, e.g., in "Motor setup" are lost. An exception: the menu language setting remains preserved.
7	The <b>Motor Setup</b> factory installed values are for variable voltage external rotor motors <b>3 ~230 V / 50 Hz</b> . After checking of the motor data the setting are to be adapted if necessary. Additional settings (⚙️) Motor Setup.
8	In menu group <b>Start</b> switch setting for <b>Motor</b> to " <b>ON</b> ". Additional settings (⚙️) Programming and selected Mode).

**Switch Motor to ON in menu group “Start”**

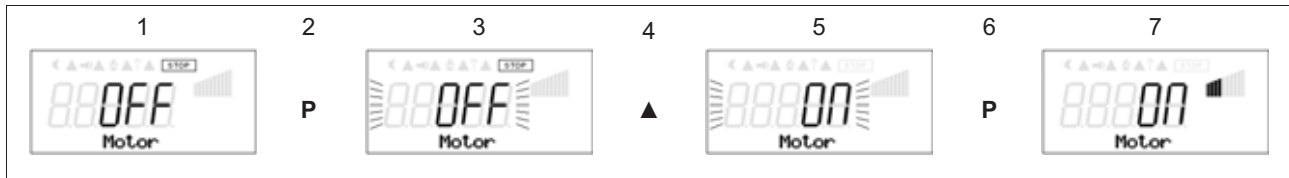

**8.3 Menu overview Mode 1.01 (without add-on modules)**

Start	Info	Setting	Events	Base setup	Controller Setup	IO Setup	Limits	Motor Setup	Diagnostic
OFF Motor	0.0 Hz Frequency	50.0 Hz Set Intern1	-0- Motor fault	<b>1.01</b> Mode	OFF PIN Protection	[1A] A Function	OFF Level. Function	6.0 A MotorRa- tedCurr.	OTC 00012:56:- 15
---- PIN input	0.0 A Motor cur- rent	----- Set Intern2	-1- Overtem- perature	0 - 10 V E1 Analog In	OFF Set protec- tion	0.0 V A min.	----- Level min	<b>230 V</b> MotorRa- tedVolt.	OTM 00010:56:- 11
GB Lan- guage	0.0 Hz Set exter- nal1	0.0 Hz Min. Speed	-2- ext. Fault	OFF E2 Func- tion	OFF Save User Setup	10.0 V A max.	----- Level max.	<b>50.0 Hz</b> Edgefre- quency	420 V DC-Voltage
OFF Reset		50.0 Hz Max. Speed	-3- Sensor 2	----- E2 Analog In	----- Limit	OFF A Inverting	----- Level Delay	<b>50.0 Hz</b> Max. Fre- quency	32.4 °C Heatsink
1.01 Mode		ON Set exter- nal1			----- Group 2 ON value	OFF D1 Func- tion	OFF Lmt E1 Function	40 sec Rampup time	29.5 °C Capacitor
2.35 Fcontrol					----- nmin at Group2	----- D1 Invert- ing	----- Lmt E1 min	40 sec Rampdown time	29.5 °C EMV-Filter

**9 Programming**

**9.1 Speed controller 1.01**

**9.1.1 Base setup 1.01**

	<b>Base setup</b>
	<b>Mode</b> Factory setting Mode: <b>1.01</b>
	<b>E1 Analog In</b> Selection: 0 - 20 mA, 4 - 20 mA, Bus (Inverting  IO Setup) Factory setting: 0 - 10 V
	<b>E2 Function</b> (only for special applications) Analog input 2 “E2” factory set at “OFF”. For operation with a second signal and switch over via floating contact set function for “E2” to <b>1E</b> ( IO Setup: function <b>4D</b> ). For operation with a second signal and automatic control at the higher level. Set “E2” Function to <b>4E</b> .

<p>Base setup</p>	<p><b>Base setup</b></p>
<p>E2 Analog In</p>	<p><b>E2 Analog In</b>                  As long as no allocation has been carried out display: <input type="text" value="-----"/>                  Selection: 0 - 20 mA, 4 - 20 mA, Bus (Inverting  IO Setup)                  Factory setting: 0 - 10 V</p>

9.1.2 Setting for operation **1.01**

<p>Setting</p>	<p><b>Setting</b></p>
<p>Set Intern1</p>	<p><b>Set Intern1</b>                  Setting range manual speed setting: 0...setting "Max. Frequency" ( Motor Setup)                  Factory setting: 50.0 Hz</p>
<p>Set Intern2</p>	<p><b>Set Intern2</b>                  Setting "Set Intern2" e.g. reduced value for night operation.                  Switch over intern 1/2 by external contact (as long as no allocation is carried out:                  Display: <input type="text" value="-----"/>  IO Setup)</p>
<p>Min. Speed</p>	<p><b>Minimal Speed</b>                  Setting range: 0... "Max. Frequency" ( Motor Setup)                  Factory setting: 0.0 Hz</p>
<p>Max. Speed</p>	<p><b>Maximal Speed</b>                  Setting range: Setting "Max. Frequency" ( Motor Setup) - "Min. Speed"                  Factory setting: 50.0 Hz</p>
<p>Set external1</p>	<p><b>Set external1</b>                  "ON" (factory setting) = speed setting by external Signal                  "OFF" = Setting "Set Intern1"</p>

Diagram setting signal and output voltage (Idealized principle diagram)

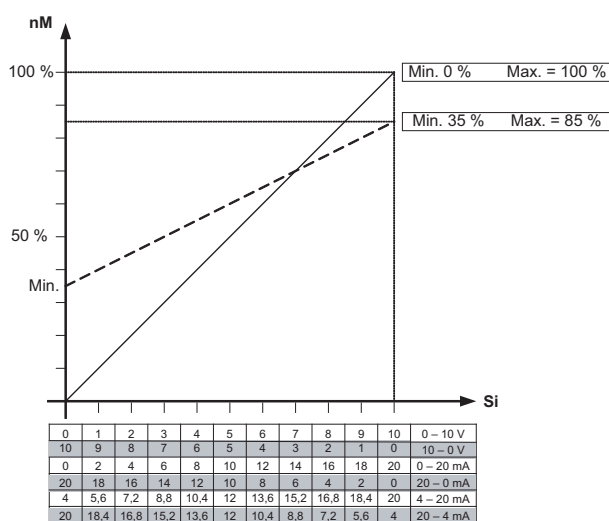





09.05.2007  
v\_nmotor\_101.vsd

nM Motor speed  
Si Signal









9.2 Temperature control **2.01...2.05**

9.2.1 Basic setting **2.01... 2.05**

	<p><b>Base setup</b></p>
	<p><b>Mode</b> Mode selection e.g. <b>2.01</b></p>
	<p><b>E1 Analog In</b> In all group 2 operating modes (2.01, 2.02, 2.03, ....) “E1 analogue In” factory set to “TF” (measuring range -27...+75 °C).  Alternative selection Sensor: “MTG120V” Aktive sensor with 0 - 10 V output (⚡jumper for input signal) and proportional measuring range: -10...+120 °C.  Alternative selection signal: 0 - 10 V, 0 - 20 mA, 4 - 20 mA (⚡jumper for input signal) accordingly inserted. The sensor measurement-range must be entered in order to correctly display the actual value. Example with a 0 - 10 V sensor and 0 - 100 °C measurement range: E1 Analog In = 0 - 10 V, E1 Min. = 0.0 °C, E1 Max. = 100.0 °C, E1 Decimally = 1, E1 Unit = °C</p>
	<p><b>E1 Offset</b> Sensor calibration with calibrated comparison device</p>
	<p><b>E2 Function</b></p> <ul style="list-style-type: none"> <li>• Funktion <b>1E</b> = External Setpoint via external signal (0 - 10 V) instead of “Setpoint 1”.             <ul style="list-style-type: none"> <li>– For sensor type “E1 Analog In” = “TF”: 0 - 10 V <math>\hat{=}</math> -27...+75.0 °C.</li> <li>– For sensors with active signal: 0 - 10 V <math>\hat{=}</math> 0 - 100 % sensor measuring range.</li> </ul> </li> <li>• Funktion <b>2E</b> = External manual operation via external signal (0 - 10 V). Switch over between settings on the device and external manual operation via digital input (⚡ IO Setup).</li> <li>• Funktion <b>7E</b> Measurement value = Measurement value e.g. for limit indication, display in Info menu “E2 Actual”.</li> </ul> <p><b>Modes with two sensors</b> The function is automatically jointly programmed in operating modes using 2 sensors. The second analog input is thus allocated and additional function allocations are not possible.</p> <ul style="list-style-type: none"> <li>• <b>2.04</b> E2 Function at <b>4E</b> preprogrammed = comparison value with control to higher temperature. Alternative: average of 2 measuring points for this must be reprogrammed on function <b>3E</b> preprogrammed sensor type “TF”.</li> <li>• <b>2.05</b> E2 Function at <b>5E</b> preprogrammed = regulation on difference temperature between sensor 1 and sensor 2. Preprogrammed sensor type “TF”.</li> </ul>

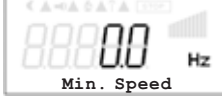
9.2.2 Settings for operation modes **2.01**... **2.05**

- 2.01** Temperature control simple
- 2.02** Temperature control depending on outdoor temperature (Special function: Sensor connection at “E2”, display and setting under “E1”).
- 2.03** Temperature control with pre-programmed additional functions (heating, shutter, temperature monitoring).
- 2.04** Temperature control with 2 sensors  
 Comparison with control to higher value “E2 Function” set to comparison **4E**. Display during operation: “Control value ”  
 Alternative: Average calculation of 2 measuring places “E2 Function” set to **3E**. Display during operation: “Average E1 / E2 ”
- 2.05** Temperature control with 2 sensors, regulation on difference temperature.  
 Display during operation: “Value of E1 - E2” in K, “E1” = reference temperatur, “E2” causes positiv (E2 < E1) or negative (E2 > E 1) difference.

	<p><b>Setting</b></p>
	<p><b>Setpoint1</b>                  Setting range: with passive sensor type “TF..”: -27.0...75 °C                  Factory setting: <b>2.01</b>, <b>2.03</b>, <b>2.04</b> : 20.0 °C                  at <b>2.02</b> : 5.0 °C                  at <b>2.05</b> : 0.0 °C                  Setting range: at active sensor type “MTG-120V”: -10.0 °C...+120.0 °C                  Factory setting: <b>2.01</b> - <b>2.05</b> : 55.0 °C</p>
	<p><b>Setpoint2</b>                  Setting “Setpoint 2” e.g. reduced value for night operation.                  Switch over Setpoint 1/2 by external contact (as long as no allocation is carried out:                  Display: <b>----</b> (IOSetup).</p>
	<p><b>Pband</b>                  small control range = short control times                  big control range = longer control times and (higher controller stability)</p>
	<p>passive Sensor type “TF..”                  Setting range: 0-120.0 K (Kelvin)                  Factory setting: 5.0 K, (at <b>2.02</b>: 20.0 K)</p> <p>active Sensor type “MTG-120V”                  Setting range: -10.0...+120.0 K                  Factory setting: 65.0 K</p>
	<p><b>Minimal Speed</b>                  Setting range: 0... “Max. Frequency” (Motor Setup)                  Factory setting: 0.0 Hz</p>
	<p><b>Maximal Speed</b>                  Setting range: Setting “Max. Frequency” (Motor Setup) - “Min. Speed ”                  Factory setting: 50.0 Hz</p>
	<p><b>Manual mode</b>                  “OFF” = automatic control as function of the set parameters (Factory setting)                  “ON” = automatic control without function, speed setting in menu “Speed manual”</p>
	<p><b>Speed manual</b>                  Manual speed setting without influence by the external signal.                  Activation by menu “Manual mode” or external contact at digital input (IO Setup).                  Setting range: 0... “Max. Frequency” (Motor Setup)                  Factory setting: 50.0 Hz</p>
	<p>For information about deactivated regulation the adjusted value for manual speed is indicated alternating with the actual value.</p>

### 9.2.3 Functional diagrams temperature control

Example 1: Temperature control in factory setting “Cooling function” (Idealized principle diagram)

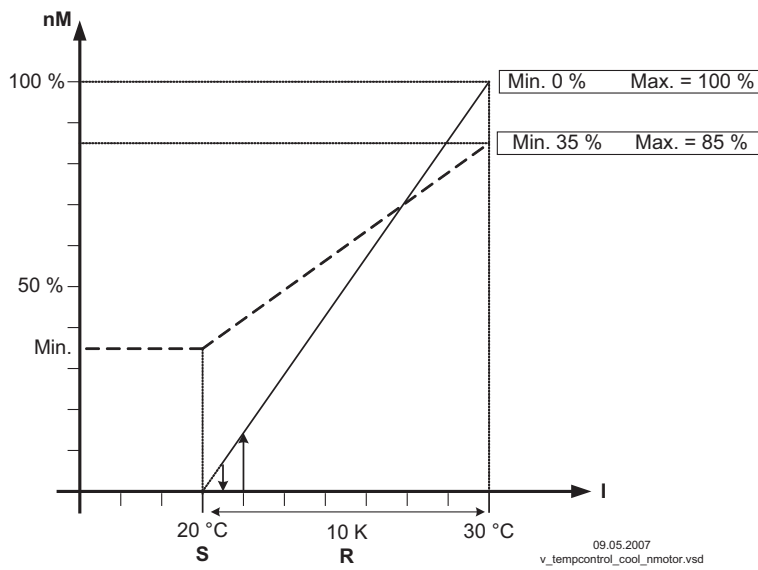

(Controller Setup: “Val > Set = n+” to “ON”)

*nM* Motor speed  
*S* Setpoint  
*R* Pband  
*I* Actual value

Example 2: Temperature control in “Heating function” (Idealized principle diagram)

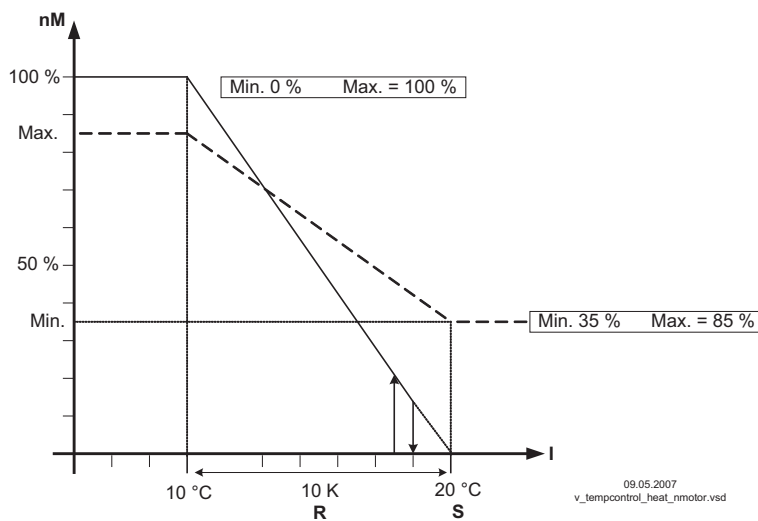



(Controller Setup: “Val > Set = n+” to “OFF”)

*nM* Motor speed  
*S* Setpoint  
*R* Pband  
*I* Actual value



**9.2.4 Additional for mode 2.03: Signal output 0 - 10 V**

The 0 - 10 V output signal can, e.g., be used for triggering a shutter or heating.

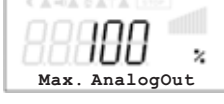
	<p><b>Offset AnalogOut</b></p> <p>The target value for this output is the target value (Setpoint) for the ventilation “offset” setting.</p> <p>Adjustment: range +/- 10 K relative to the active Setpoint.</p> <p>Example for triggering a shutter servomotor: At factory setting “0 K” = synchronous operation.</p> <p>The analog output is factory set to increasing activation during increasing temperature. Reprogramming to “Heating function”, i.e., increasing modulation during decreasing temperature is possible (IO Setup).</p>
	<p><b>Pband AnalogOut</b></p> <p>Pband AnalogOut = separately adjustable range of control (P-band) for 0 - 10 V output</p> <p>Setting range: 0...102.0 K</p> <p>Factory setting: 2.0 K</p>
	<p><b>Min. AnalogOut</b></p> <p>Min. AnalogOut = Minimal output voltage</p> <p>Setting range: 0...100 % = 0 - 10 V</p> <p>Factory setting: 0 %</p>
	<p><b>Max. AnalogOut</b></p> <p>Max. AnalogOut = Maximal output voltage,</p> <p>Setting range: 100...0 % = 10 - 0 V</p> <p>Factory setting: 0.0 K</p>

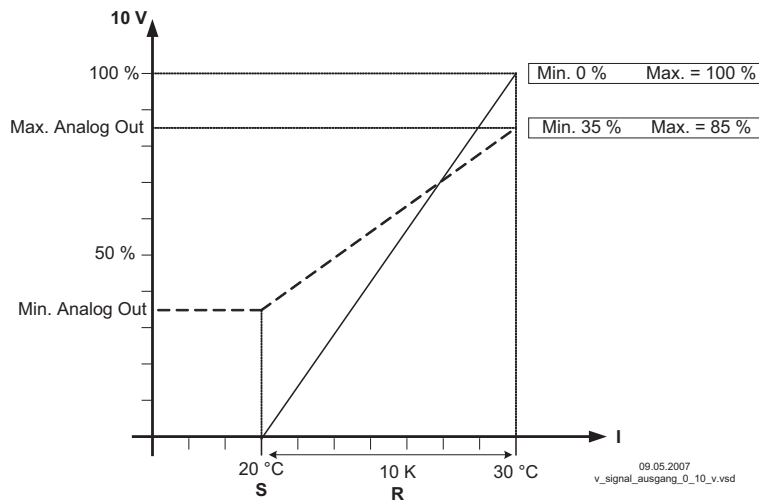

**Example for signal out 0 - 10 V (IO Setup: “A function” = 6A)**



Example: Setpoint ventilation 25.0°C, Offset -5.0 K, Pband 10.0 K

- S Setpoint Ventilation +/- Offset
- R Pband
- I Actual value

9.2.5 For mode **2.03**: Relay output for Heating or Cooling

 <p>OffsetDigitalOut</p>	<p><b>OffsetDigitalOut</b>                  Offset Digital Out = Offset for relay output (“K2” is pre-programmed by the factory).                  The relay operating point deviates by the adjusted offset of the Setpoint of the ventilation (if relay “K2” not inverted, terminal “21”-“24” bridged).                  Setting range: -10.0...+10.0 K                  Factory setting: -1.0 K</p> <ul style="list-style-type: none"> <li>• “0.0 K” set, i.e. heating “ON” when: actual value = Setpoint</li> <li>• During negative offset value heating “ON” when: actual value = Setpoint - offset</li> <li>• During positive offset value heating “ON” when: actual value = Setpoint + offset</li> </ul>
 <p>Hyst.DigitalOut</p>	<p><b>Hyst.DigitalOut</b>                  Switching hysteresis of the relay                  Setting range: 0...10 K, Factory setting: 1.0 K (Kelvin)</p>

Temperature variation with factory setting **[9K]** in IO Setup e. g. for controlling a Heating.

If the ambient temperature is lower than the set operating point, the heating remains switched on. If the ambient temperature exceeds the set operating point of the heating by 2 K (Kelvin), the heating is switched off. I.e., the release point is situated at the hysteresis value over the operating point.

Example:  
 Setpoint 15.0 °C, Offset +5.0 K, Hysteresis 2.0 K

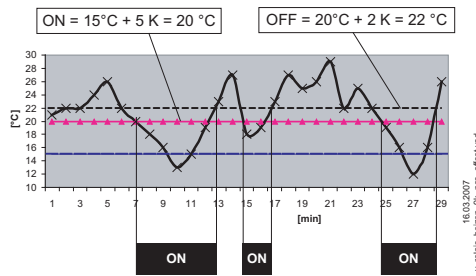

Example:  
 Setpoint 20.0 °C, Offset -5.0 K, Hysteresis 2.0 K

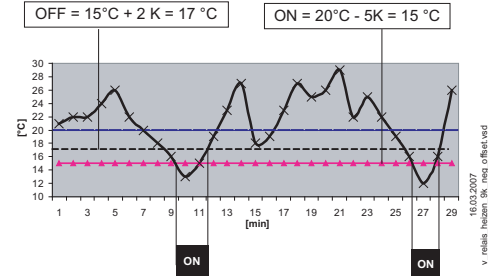

The activated heating is indicated over the fire symbol in the display.

Temperature variation with reprogramming to **[10K]** for “K2” in IO Setup, e.g., for activation of the Cooling.

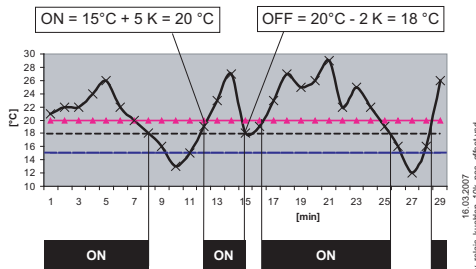

Example:  
 Setpoint 15.0 °C, Offset +5.0 K, Hysteresis 2.0 K



If the ambient temperature is higher than the set operating point, the cooling remains switched on. If the ambient temperature falls below the set operating point of the cooling by 2 K (Kelvin), it is switched off. I.e., the OFF point is situated at the hysteresis value under the ON point.

**9.2.6 For mode 2.03 Relay output for temperature monitoring**

If the set value for the “minimum alarm” is not reached or the set value for the “maximum alarm” is exceeded, a message is generated via the alarm symbol in the display. In addition, „Lmt E1 min“ is displayed alternately with the actual value for the minimum alarm and Lmt E1 max for the „Maximum alarm“. An external message follows via the factory-assigned “K1” relay. (IO Setup: K1 function = 2K).

 <p>Alarm Minimum</p>	<p><b>Alarm Minimum</b>                  Setting range: OFF / -26.9...75.0 °C                  Factory setting: 0.0 °C</p>
 <p>Alarm Maximum</p>	<p><b>Alarm Maximum</b>                  Setting range: OFF / -26.9...75.0 °C                  Factory setting: 40.0 °C</p>



Example for display if falling below setting “Alarm Minimum” alternating to the actual value display.  
 Relay “K1” disengages (if not inverted).



Example for display if exceeding setting “Alarm Maximum” alternating to the actual value display  
 Relay “K1” disengages (if not inverted).

**9.3 Pressure control for condensers refrigeration 3.01...3.04**







**9.3.1 Base setup 3.01...3.04**

	<p><b>Base setup</b></p>
	<p><b>Mode</b> Mode selection e.g. <b>3.01</b></p>
	<p><b>E1 Analog In</b> For all Modes in Group 3 (<b>3.01</b>, <b>3.02</b>, <b>3.03</b>, ...) "E1 Analog In" factory setting to "MBG-30I". (measuring range 0..30 bar) proportional output 4 - 20 mA Selection sensor: MBG-30I, MBG-50I, DSF2-25 Alternative selection signal: 0 - 10 V, 4 - 20 mA, (⚡ jumper for input signal) accordingly inserted. The sensor measurement-range must be entered in order to correctly display the actual value. Example 0 - 10 V sensor and measuring range 0 - 20 bar: E1 Analog In = 0 - 10 V, E1 Min. = 0.0 bar, E1 Max. = 20.0 bar, E1 Decimals = 1, E1 Unit = bar</p>
	<p><b>E1 Offset</b> Sensor calibration with calibrated comparison device</p>
	<p><b>E1 Refrigerant</b> With <b>3.02</b> and <b>3.04</b> operating modes with input of the refrigerant, the device automatically calculates the corresponding temperature for the measured pressure. The settings for offset, target value and the controlling range are then carried out in °C or K. Calculation for relative pressure (differential measurement of pressure relative to ambient pressure). No further settings are necessary for pressure sensors model e.g. "MBG-30I" or "MBG-50I" (measurement range 0 - 30 bar or 0 - 50 bar). In the case of sensors with other measurement ranges, the "E1 Min. value" and the "E1 Max. Value". Setting in "bar" although unit display is in "°C"!</p>
	<p><b>E2 Function</b> (only for special applications)</p> <ul style="list-style-type: none"> <li>External setpoint = Function <b>1E</b> by external signal (0 - 10 V) instead of "Setpoint 1". 0 - 10 V <math>\hat{=}</math> 0 - 100 % sensor measuring range.</li> <li>External manual operation via external signal (0 - 10 V) = Function <b>2E</b>. Switch over between settings on the device and external manual operation via digital input (⚡ IO Setup).</li> <li>Measurement value = function <b>7E</b> e.g. for limit indication, display in Info menu "E2 Actual".</li> </ul> <p><b>Modes 3.03 and 3.04 with two sensors</b> The function is automatically jointly programmed in operating modes using 2 sensors. The second analog input is thus allocated and additional function allocations are not possible. With <b>3.03</b> and <b>3.04</b> E2 Function at <b>4E</b> preprogrammed = comparison value with control to higher value (two circuit condensers).</p>

Selection of the refrigerants:								
R12	R13	R13b1	R22	R23	R32	R114	R134a	R142B
R227	R401	R401A	R401B	R402	R402A	R402B	R404A	R407A
R407B	R407C	R410A	R500	R502	R503	R507	R717	

9.3.2 Setting for operation modes **3.01... 3.04**

- 3.01** Pressure control condensers, setting Setpoint in bar
- 3.02** Pressure control for condensers with input for refrigerant, Setpoint in °C
- 3.03** Two sensors for dual circuit condenser. Automatic regulation to the highest pressure (selection amplifier integrated) operation display: “Control value”, Setpoint in bar
- 3.04** Two sensors for dual circuit condenser with input for refrigerant automatic regulation to the highest pressure (selection amplifier). Setpoint in °C , also for different refrigerants suitably there comparison of the temperatures. Display during operation: “Control value ”

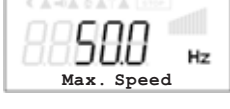
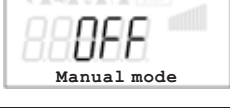
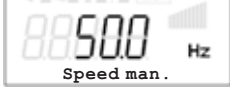
 <p>Setting</p>	<b>Setting</b>
 <p>Setpoint1</p>	<b>Setpoint1</b> <b>3.01</b> and <b>3.03</b> Setting range: in measuring range of sensor, factory setting: 12.0 bar <b>3.02</b> and <b>3.04</b> Setting range: dependent on the selected refrigerant, factory setting: 35.0°C
 <p>Setpoint1</p>	
 <p>Setpoint2</p>	<b>Setpoint2</b> Setting “Setpoint 2” e.g. reduced value for night operation. Switch over Setpoint 1/2 by external contact (as long as no allocation is carried out: Display: [----] (IO Setup).
 <p>Pband</p>	<b>Pband</b> small control range = short control times big control range = longer control times and (higher controller stability) <b>3.01</b> and <b>3.03</b> Setting range: in measuring range of sensor, factory setting: 5.0 bar <b>3.02</b> and <b>3.04</b> Setting range: dependent on the selected refrigerant and in measuring range of sensor, factory setting: 7.0 K
 <p>Pband</p>	
 <p>Min. Speed</p>	<b>Minimal Speed</b> Setting range: 0... “Max. Frequency” (Motor Setup) Factory setting: 0.0 Hz
 <p>Max. Speed</p>	<b>Maximal Speed</b> Setting range: Setting “Max. Frequency” (Motor Setup) - “Min. Speed ” Factory setting: 50.0 Hz
 <p>Manual mode</p>	<b>Manual mode</b> “OFF” = automatic control as function of the set parameters (Factory setting) “ON” = automatic control without function, speed setting in menu “Speed manual”
 <p>Speed man.</p>	<b>Speed manual</b> Manual speed setting without influence by the external signal. Activation by menu “Manual mode” or external contact at digital input (IO Setup). Setting range: 0... “Max. Frequency” (Motor Setup) Factory setting: 50.0 Hz For information about deactivated regulation the adjusted value for manual speed is indicated alternating with the actual value.

**9.3.3 Functional diagrams pressure control condensers**

Functional diagram for Mode **3.01** and **3.03** (Idealized principle diagram)

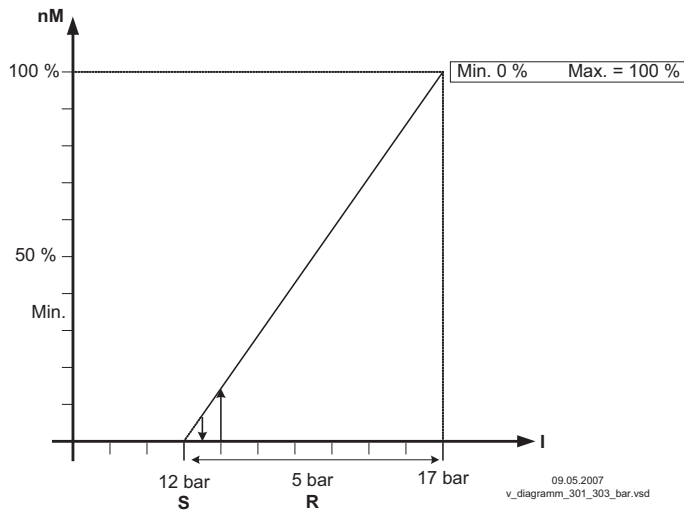

*nM* Motor speed  
*S* Setpoint  
*R* Pband  
*I* Actual value

Functional diagram for Mode **3.02** and **3.04** (Idealized principle diagram)

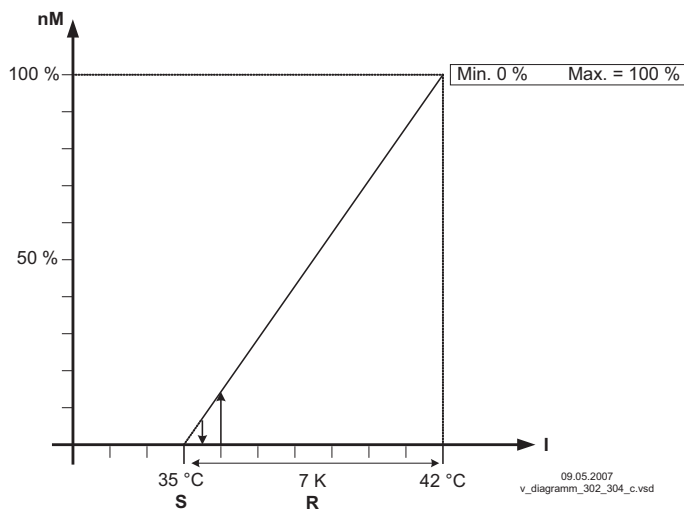

*nM* Motor speed  
*S* Setpoint  
*R* Pband  
*I* Actual value







**Information**

The factory default presets must be adapted to match the system conditions by a competent person.





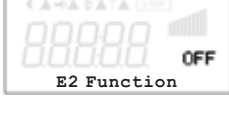



**9.4 Pressure control airconditioning 4.01... 4.03**

**9.4.1 Base setup 4.01... 4.03**

	<p><b>Base setup</b></p>
	<p><b>Mode</b> Mode selection e.g. <b>4.01</b></p>
	<p><b>E1 Analog In</b> In all group 2 operating modes 4 (<b>4.01</b>, <b>4.02</b>, <b>4.03</b>, ...) "E1 Analog In" factory setting "DSG200". Selection sensor measuring range: "DSG 50", "DSG100*", "DSG200", "DSG300*", "DSG500", "DSG1000", "DSG2000", "DSG4000", "DSG6000" (* no standard type). For sensors with 0 - 20 mA or 4 - 20 mA signal (⚙️ jumper for input signal), select measuring range "DSG50"... "DSG6000". For not preprogrammed measuring range the sensor measurement range must be entered in order to display the actual value correctly. Example with a 0 - 10 V sensor and 0 - 400 Pa measurement range (proportional output signal): E1 Analog In = 0 - 10 V, E1 Min. = 0.0 Pa, E1 Max. = 400 Pa, E1 Dezimal = 1, E1 unit = Pa</p>
	<p><b>E1 Offset</b> Sensor calibration with calibrated comparison device</p>
	<p><b>E2 Function (only for special applications)</b></p> <ul style="list-style-type: none"> <li>• External setpoint = Function <b>1E</b> by external signal (0 - 10 V) instead of "Setpoint 1". 0 - 10 V <math>\triangleq</math> 0 - 100 % sensor measuring range.</li> <li>• External manual operation via external signal (0 - 10 V) = Function <b>2E</b> Switch over between settings on the device and external manual operation via digital input (⚙️ IO Setup).</li> <li>• Measurement value = function <b>7E</b> e.g. for limit indication, display in Info menu "E2 Actual."</li> </ul> <p><b>Modes 4.02 and 4.03 with two sensors</b> The function is automatically jointly programmed in operating modes using 2 sensors. The second analog input is thus allocated and additional function allocations are not possible. For <b>4.02</b> E2 Function at <b>6E</b> preprogrammed = sensor for setpoint lowering. Preprogrammed sensor type "TF.." For <b>4.03</b> <b>E2</b> Function at <b>6E</b> preprogrammed = sensor for setpoint lowering. - preprogrammed sensor type "BUS" - measuring range -35.0...+65.0 °C In "IO Setup": For enable "ON" / "OFF" via Bus: - D1 function = <b>1D</b> - D1 Busmode = "ON" For switch over setpoint 1 / 2 via Bus: - D2 function = <b>5D</b>, - D2 Busmode = "ON"</p>

9.4.2 Setting for operation modes **4.01... 4.03**

- **4.01** pressure control, setpoint in Pa
- **4.02** and **4.03** Pressure control for ventilation systems setpoint depending on outdoor temperature

	<p><b>Setting</b></p>
	<p><b>Setpoint1</b> Setting range: in measuring range of sensor Factory setting: 100 Pa</p>
	<p><b>Setpoint2</b> Setting "Setpoint 2" e.g. reduced value for night operation. Switch over Setpoint 1/2 by external contact (as long as no allocation is carried out: Display: [----] (IO Setup).</p>
	<p><b>Pband</b> small control range = short control times big control range = longer control times and (higher controller stability) Setting range: in measuring range of sensor Factory setting: 100 Pa</p>
	<p><b>Minimal Speed</b> Setting range: 0... "Max. Frequency" (Motor Setup) Factory setting: 0.0 Hz</p>
	<p><b>Maximal Speed</b> Setting range: Setting "Max. Frequency" (Motor Setup) - "Min. Speed" Factory setting: 50.0 Hz</p>
	<p><b>Manual mode</b> "OFF" = automatic control as function of the set parameters (Factory setting) "ON" = automatic control without function, speed setting in menu "Speed manual"</p>
	<p><b>Speed manual</b> Manual speed setting without influence by the external signal. Activation by menu "Manual mode" or external contact at digital input (IO Setup). Setting range: 0... "Max. Frequency" (Motor Setup) Factory setting: 50.0 Hz For information about deactivated regulation the adjusted value for manual speed is indicated alternating with the actual value.</p>



**Additional menu item for mode 4.02 and 4.03 with outside-temperature dependent target-setpoint.**

Outside-temperature dependent target-setpoint

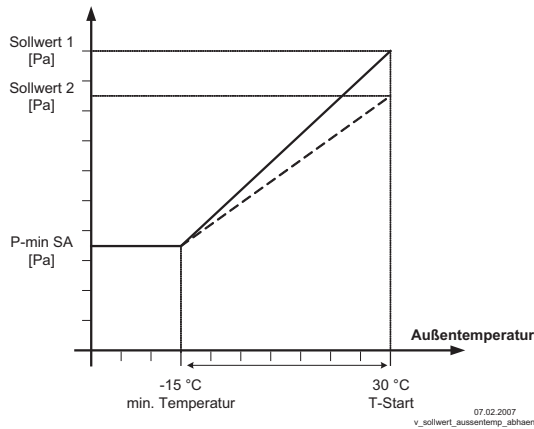

An outside temperature compensation can be activated (sensor connection “E2” = “Analog In 2”) when being operated as a pressure regulation device.







An optimal building climate, e.g., can be achieved through this. Through this function, the set and active “Setpoint 1” or “Setpoint 2” is automatically changed proportional to the measured outside temperature (Info: “Setpoint control”).

- S1 Setpoint1
- S2 Setpoint2
- P-Min SA Minimum pressure
- T-min Minimum temperature
- T-Start Setpoint reducing will start below this outside temperature
- AT Outdoor temperature

	<p><b>T-Band SA</b> Temperature range in which the setpoint change continuously with outside temperature</p>
	<p><b>T-Start SA</b> Setpoint reducing will start below this outside temperature</p>
	<p><b>P-Min SA</b> Minimum pressure for very low outside temperature</p>

## 9.5 Volume control **5.01**...**5.02**

### 9.5.1 Basic setting **5.01** and **5.02**

	<b>Base setup</b>
	<b>Mode</b> Mode selection e.g. <b>5.01</b>
	<b>E1 Analog In</b> In all group operating modes 5 ( <b>5.01</b> and <b>5.02</b> ) "E1 Analog In" factory setting "DSG200." Selection sensor measuring range: "DSG 50", * "DSG100", "DSG200", * "DSG300", "DSG500", "DSG1000", "DSG2000", "DSG4000", "DSG6000" (* no standard type). For sensors with 0 - 20 mA or 4 - 20 mA signal (⚡ jumper for input signal), select measuring range "DSG50"... "DSG6000".
	<b>K Factor</b> Input of the "K factor" dependent on the fan (inlet duct). setting range: 0...7.000 Factory setting: 75
	<b>E1 Offset</b> Sensor calibration with calibrated comparison device
	<b>E2 Function</b> (only for special applications) <ul style="list-style-type: none"> <li>External setpoint = Function <b>1E</b> by external signal (0 - 10 V) instead of "Setpoint 1". 0 - 10 V <math>\triangleq</math> 0 - 100 % setting range</li> <li>External manual operation via external signal (0 - 10 V) = Function <b>2E</b> Switch over between settings on the device and external manual operation via digital input (⚡ IO Setup).</li> <li>Measurement value = function <b>7E</b> e.g. for limit indication, display in Info menu "E2 Actual"</li> </ul> <b>Modes <b>5.02</b> with two sensors</b> Modes with two sensors The function is automatically jointly programmed in operating modes using 2 sensors. The second analog input is thus allocated and additional function allocations are not possible. For <b>5.02</b> E2 Function at <b>6E</b> preprogrammed = sensor for setpoint lowering. Pre-programmed sensor type "TF".

9.5.2 Setting for operation modes **5.01...5.02**

- **5.01** Volume control, Setpoint in m<sup>3</sup>/h
- **5.02** Volume control for ventilation systems setpoint depending on outdoor temperature.

	<p><b>Setting</b></p>
	<p><b>Setpoint1</b> Setpoint in m<sup>3</sup>/h (m<sup>3</sup>/s) Setting range: depending on measuring range of sensor and “K factor” Factory setting: 530 m<sup>3</sup>/h</p>
	<p><b>Setpoint2</b> Setting “Setpoint 2” e.g. reduced value for night operation. Switch over Setpoint 1/2 by external contact (as long as no allocation is carried out: Display: [----] (IO Setup).</p>
	<p><b>Pband</b> small control range = short control times big control range = longer control times and (higher controller stability) Setting range: depending on measuring range of sensor and “K factor” Factory setting: 530 m<sup>3</sup>/h</p>
	<p><b>Minimal Speed</b> Setting range: 0... “Max. Frequency” (Motor Setup) Factory setting: 0.0 Hz</p>
	<p><b>Maximal Speed</b> Setting range: Setting “Max. Frequency” (Motor Setup) - “Min. Speed ” Factory setting: 50.0 Hz</p>
	<p><b>Manual mode</b> “OFF” = automatic control as function of the set parameters (Factory setting) “ON” = automatic control without function, speed setting in menu “Speed manual”</p>
	<p><b>Speed manual</b> Manual speed setting without influence by the external signal. Activation by menu “Manual mode” or external contact at digital input (IO Setup). Setting range: 0... “Max. Frequency” (Motor Setup) Factory setting: 50.0 Hz For information about deactivated regulation the adjusted value for manual speed is indicated alternating with the actual value.</p>

**Additional menu item for mode 5.02 with outside-temperature dependent target-setpoint**

Outside-temperature dependent target-setpoint

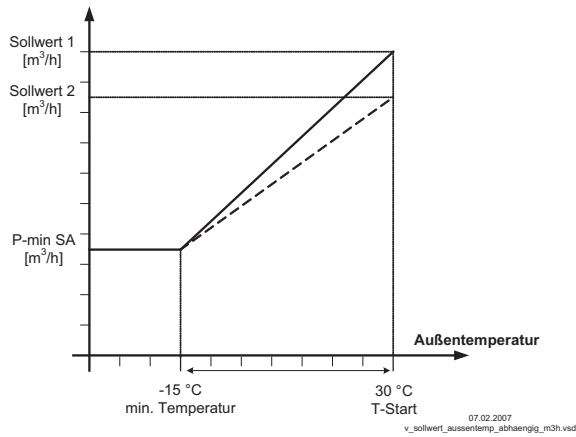

An outside temperature compensation can be activated (sensor connection “E2” to “Analog In 2”) when being operated as a air volume regulation device.





An optimal building climate, e.g., can be achieved through this. Through this function, the set and active Setpoint 1/2 is automatically changed proportional to the measured outside temperature (Info: “Setpoint control”).

- S1 Setpoint1
- S2 Setpoint2
- P-Min SA Minimum air volume
- T-min Minimum temperature
- T-Start Setpoint reducing will start below this outside temperature
- AT Outdoor temperature









	<p><b>T-Band SA</b> Temperature range in which the setpoint change continuously with outside temperature</p>
	<p><b>T-Start SA</b> Setpoint reducing will start below this outside temperature</p>
	<p><b>P-Min SA</b> Minimum pressure for very low outside temperature</p>

## 9.6 Air velocity control **6.01**









### 9.6.1 Base setup **6.01**

	<b>Base setup</b>
	<b>Mode</b> Mode selection <b>6.01</b>
	<b>E1 Analog In</b> For mode <b>6.01</b> "E1 Analog In" factory setting to "MAL1" Selection sensor measuring range: MAL1, MAL10 Alternative selection signal: 0 - 10 V, 0 - 20 mA, 4 - 20 mA (⚡ jumper for input signal). The sensor measurement range must be entered in order to display the actual value correctly. Example with a 0 - 10 V sensor and 0 - 5 m/s measurement range (proportional output signal). E1 Analog In = 0 - 10 V, E1 Min. = 0.0 m/s, E1 Max. = 5.0 m/s, E1 Decimals = 1, E1 Unit = m/s
	Sensor calibration with calibrated comparison device
	<b>Function Analog Input 2</b> <ul style="list-style-type: none"> <li>External setpoint = Function <b>1E</b> by external signal (0 - 10 V) instead of "Setpoint 1". 0 - 10 V <math>\hat{=}</math> 0 - 100 % setting range</li> <li>External manual operation via external signal (0 - 10 V) = Function <b>2E</b> Switch over between settings on the device and external manual operation via digital input (⚡ IO Setup).</li> <li>Measurement value = function <b>7E</b> e.g. for limit indication, display in Info menu "E2 Actual."</li> </ul>











9.6.2 Settings for operation modes **6.01**

 <p>Setting</p>	<p><b>Setting</b></p>
 <p>Setpoint1</p>	<p><b>Setpoint1</b>                  Setting range: in measuring range of sensor                  Factory setting: 0.50 m/s</p>
 <p>Setpoint2</p>	<p><b>Setpoint2</b>                  Setting "Setpoint 2" e.g. reduced value for night operation.                  Switch over Setpoint 1/2 by external contact (as long as no allocation is carried out:                  Display: <input type="checkbox"/> IOSetup).</p>
 <p>Pband</p>	<p><b>Pband</b>                  small control range = short control times                  big control range = longer control times and (higher controller stability)                  Setting range: in measuring range of sensor                  Factory setting: 0.50 m/s</p>
 <p>Min. Speed</p>	<p><b>Minimal Speed</b>                  Setting range: 0... "Max. Frequency" (Motor Setup)                  Factory setting: 0.0 Hz</p>
 <p>Max. Speed</p>	<p><b>Maximal Speed</b>                  Setting range: Setting "Max. Frequency" (Motor Setup) - "Min. Speed"                  Factory setting: 50.0 Hz</p>
 <p>Manual mode</p>	<p><b>Manual mode</b>                  "OFF" = automatic control as function of the set parameters (Factory setting)                  "ON" = automatic control without function, speed setting in menu "Speed manual"</p>
 <p>Speed man.</p>	<p><b>Speed manual</b>                  Manual speed setting without influence by the external signal.                  Activation by menu "Manual mode" or external contact at digital input (IO Setup).                  Setting range: 0... "Max. Frequency" (Motor Setup)                  Factory setting: 50.0 Hz</p>
<p>For information about deactivated regulation the adjusted value for manual speed is indicated alternating with the actual value.</p>	

### 9.7 Menu group Start

	<p><b>Start</b></p>
	<p><b>Motor</b> (Menu dependent on device type available) In this menu point the modulation for the motor can be switched on and off (ON / OFF). Factory setting to <b>OFF</b>, this prevents the system from inadvertently starting up before configuration is complete.</p>
<p><b>Attention!</b> <b>No disconnection (isolation) when switched off, in accordance with VBG4 §6)!</b></p>	
	<p><b>PIN input</b> The service menu for the installation can be protected against unintentional changes by a pin code. With further pin codes putting back to pre-setting is possible.</p>
<p><b>PIN 0010</b> Opening service menu, if PIN-protection activated</p>	
<p><b>PIN 1234</b> Opening “setting”. if “set protection” = “ON” (☞ Controller Setup)</p>	
<p><b>PIN 9090</b> Restore user setting</p>	
<p><b>PIN 9091</b> Save user setting (corresponds function “Save user setup” = “ON”☞ Controller Setup)</p>	
<p><b>PIN 9095</b> Restore factory setting = delivery status</p>	
	<p><b>Language</b> Menu language by the factory set to English. In this menu different national languages can be selected (GB = English, D = German ...).</p>
	<p><b>Reset</b> Complete re-start of the device</p>
	<p><b>Mode</b> Query of the operating mode (e.g. <b>1.01</b> for speed controller)</p>
	<p><b>Device name</b> Display of device name and software version</p>
	<p>Individual unit number (Menu dependent on device type available)</p>
	<p>Version number internal motor controller (Menu dependent on device type available)</p>

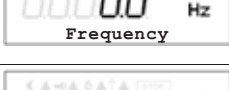
9.8 Menu group Info

	<p><b>Menu group Info</b></p>	
<p><b>Info for mode speed controller 1.01</b></p>		
	<p>Inverter output frequency.</p>	
	<p>Display of motor current (Metering precision approx. +/-10%)</p>	
	<p>Display of the currently active default signal. The percentage corresponds to the internal actuation of the power component under consideration of the settings "Min. speed" and "Max. speed". 0 - 100 % <math>\triangle</math> 0 - 10 V, 10 - 0 V, 0 - 20 mA, 20 - 0 mA, 4 - 20 mA, 20 - 4 mA</p>	
<p>Display:</p>		<p>The device operates at:</p>
<p>Set "external1"</p>		<p>Signal to "E1" / "GND"</p>
<p>Set "External2"</p>		<p>Signal to "E2" / "GND"</p>
<p>Set "Intern1"</p>		<p>Menu "Set Intern1"</p>
<p>Set "Intern2"</p>		<p>Menu "Set Intern2"</p>
<p><b>Info for mode controller 2.01... 6.01</b></p>		
	<p>Current actual value measured on the sensor 1. Depending sensor-type in: mbr, m<sup>3</sup>/s, m/s, Pa, %, bar, m<sup>3</sup>/h, °C, V, mA, etc.</p>	
	<p>For operation with two sensors display for "2 actual". If function not active, display [----]</p>	
	<p>Display of the active target value at which the device operates. "Setpoint1" Menu "Setting" "Setpoint2" Menu "Setting" "Ext. Setpoint" = setting by external signal 0 - 10 V. With activated manual mode the display constantly changes between actual value and value for manual mode.</p>	
	<p>Inverter output frequency</p>	
	<p>Display of motor current (Metering precision approx. +/-10%)</p>	
	<p>Momentarily status for minimum speed cut off "ON" = switch off, if Setpoint (+/- "Min. speed cut off") is reached. "OFF" = no switch off that means operation with minimum rate of air.</p>	



## 9.9 Controller Setup

### 9.9.1 PIN protection activate, PIN 0010

	<p>The adjustments for the installation in the service level can be protected against unintentional modifications. To do this, activate the “PIN protection” = “ON”. In order to simplify the initial start-up operation, the service level in the factory setting is free = “OFF” i.e. accessible without <b>PIN 0010</b>.</p>
---	---



#### Information

After installation of the device has been carried out, “PIN-Protection” should be activated = “ON”

### 9.9.2 PIN protection activate, PIN 1234

	<p>The “Settings” menu for the user’s basic settings (Setpoint, default value, min, max ..) are freely accessible when using the factory settings (i.e. without “PIN”). If necessary, these can also be protected against unauthorized modifications by using a “<b>PIN 1234</b>” . For this, the settings protection must be programmed to “ON”. The settings menu is then no longer visible without inputting a PIN!</p>
<p>Function only in combination with activated PIN-Protection!</p>	

### 9.9.3 Save user settings restore with PIN 9090

	<p>The individually made device configurations (User Settings) can be saved and, with the corresponding PIN input (9091), can be reestablished. By entering <b>PIN 9090</b> the individually made device configurations can be reestablished (☞ Start - PIN Input).</p>
--	---



#### Information



By entering “PIN 9095” in the “PIN” menu in the “start” menu-group, the device is entirely reset to the pre-delivery condition.  
**Any changes that have been made to the settings are thus lost!**

### 9.9.4 Sensor Alarm ON / OFF

Function only in controller mode (2.01)!

For “E1 Analog In” and if activated for sensor 2 “E2 Analog In”.

In case of an interruption or short-circuit in the sensor conductor, or in case of measured values that lie outside of the device’s measurement range, a time-delayed fault indication takes place.

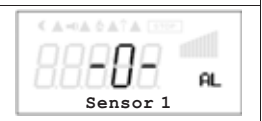
	<p>With “Alarm Sensors” = “OFF” (factory setting). Indicated sensor disturbances are displayed as “Message” alternating to the actual value and stored in the menu of “Events”.</p>	
	<p>With “AlarmSensors” = “ON” are indicated sensor disturbances as “Alarm” alternating to the actual value and stored in the menu of “Events”. Indication via relays is possible (☞ IO Setup / function relay outputs).</p>	

9.9.5 Limit

	<p>After allocation of a digital input (IO Setup) an adjustable limitation of the modulation can be activated via a digital input (“D1”, “D2”, ..). As long as no allocation has been carried out “IO Setup”. Display: <span style="border: 1px solid black; padding: 2px;">----</span></p>
--	---

<p>“Limit value” = max. possible modulation (e.g. speed reduction during night operation by time switch). Setting range: “Limit” = “n-max” up to “n-min”. Factory setting: 100 % <math>\hat{=}</math> max. modulation, i. e. no limit. Setting depending on device type in: % or rpm.</p>	<p>The graph plots motor speed (nM) on the y-axis (0% to 100%) against modulation percentage on the x-axis (0% to 100%). A solid line represents the speed controller's output, and a dashed line represents the limit. Two horizontal lines indicate limit settings: L = 70% (Min. = 0%, Max. = 100%) and L = 70% (Min. = 35%, Max. = 85%). The x-axis is divided into S (Setpoint), R (Pband), and P (P-controller) regions. A legend below the graph defines the variables: nM (Motor speed), L (Limit), S (Setpoint), R (Pband), D (Speed controller: setting signal), and P (P-controller: control deviation).</p>
---	---

9.9.6 Minimum speed cut off

	<p>This function is primarily significant for installation of the device as a pure P Controller in refrigeration and air-conditioning technology. For operation mode speed controller <b>1.01</b> without function!</p>
--	---

<p><b>Msc0 = OFF</b> (factory setting) If no “Min. speed” is adjusted, the fan stops with reaching the desired value. If “Min. speed” is adjusted (e.g. 20%), then no disconnection of the fan takes place. I.e., always a minimum ventilation is ensured (fan does not go under setting “Min. speed”).</p> <p><b>Msc0. e.g. -2.0 K</b> It takes place a disconnection from setting “Min. speed” to “0”, if the given difference is reached related to the desired value. At a plus value (+) before reaching the desired value At a minus value (-) after falling below the desired value.</p>	<p>The graph plots motor speed (nM) on the y-axis (0% to 100%) against actual value (I) on the x-axis. The x-axis has markers for 20 °C (S), 7 K (R), and 27 °C. A horizontal line at the minimum speed level is shown. A vertical line indicates a -2.0 K offset. A legend below the graph defines the variables: nM (Motor speed), S (Setpoint), R (Pband), and I (Actual value).</p>
---	---

9.9.7 Second Group

	<p><b>Second group “indirectly controlled” (picture A)</b>                  Analog output “AnalogOut 1” in IO Setup function <b>[5 A]</b> = group control is programmed. This output is employed as the default signal for a speed controller. If the default signal or the regulation deviation exceeds the group 2 switch-on point, group 1 is reduced to “n-min group 2”. Starting here, both groups run parallel at maximum power.</p>
	<p><b>Second group “100 % energized” (picture B)</b>                  Relay output (K1 or K2) in IO Setup function <b>[8 K]</b> = group control is programmed. A contactor is triggered via this relay contact, which directly switches the fans of the second group to mains voltage. If the default signal or the regulation deviation exceeds the “Group 2 ON value” switch-on point, the relay for the second group switches on and the speed of the first group is lowered to an adjustable minimum value. After that, the speed of the first group increases back up to maximum.</p>

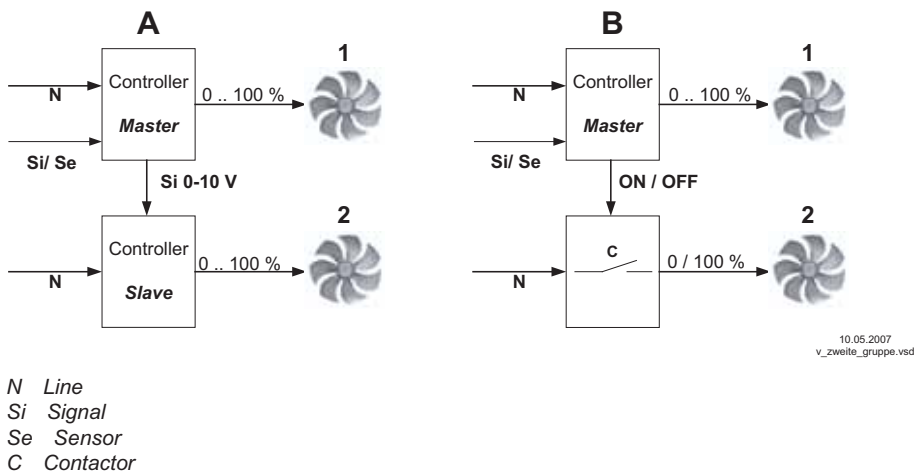





9.9.8 Reverse action of the control function

	<p><b>For the effect of the regulation there are two functions:</b></p> <ul style="list-style-type: none"> <li>• <b>ON</b> for “Val &gt; Set = n+” <math>\hat{=}</math> increasing Fanlevel for increasing actual value over Setpoint</li> <li>• <b>OFF</b> for “Val &gt; Set = n+” <math>\hat{=}</math> increasing Fanlevel for decreasing actual value below Setpoint.</li> </ul> <p>For special applications an external switch over of the control function is possible (☞ IO Setup).</p>
--	---

<p>Factory setting depending on selected mode</p>	<p>Example for temperature control (Idealized principle diagram)</p>														
<table border="1"> <thead> <tr> <th>Mode</th> <th>Controller function</th> </tr> </thead> <tbody> <tr> <td>1.01</td> <td>none</td> </tr> <tr> <td>2.01...</td> <td>ON</td> </tr> <tr> <td>3.01...</td> <td>ON</td> </tr> <tr> <td>4.01...</td> <td>OFF</td> </tr> <tr> <td>5.01...</td> <td>OFF</td> </tr> <tr> <td>6.01...</td> <td>OFF</td> </tr> </tbody> </table>	Mode	Controller function	1.01	none	2.01...	ON	3.01...	ON	4.01...	OFF	5.01...	OFF	6.01...	OFF	<p><i>nM</i> Motor speed  <i>R</i> Pband  <i>S</i> Setpoint  <i>I</i> Actual value                  OFF for Val &gt; Set = n+ = heating function                  ON for Val &gt; Set = n+ = cooling function</p>
Mode	Controller function														
1.01	none														
2.01...	ON														
3.01...	ON														
4.01...	OFF														
5.01...	OFF														
6.01...	OFF														

**9.9.9 Controller configuration**

The “controller configuration” is automatically carried out during selection of the application related mode of operation (Base setup). The factory presets in accordance with the mode of operation are based on many years of experience, which is suitable for many applications. Under special circumstances, these can be individually adapted (☞ Menu group “setting”).

 <p>Type of control</p>	<p>The type of control determines the method with which the controlled value behaves in case of a difference between the target and current values. For this, the control technology has standard algorithms, which consist of a combination of three methods:</p> <p><b>Selection P, PID:</b></p> <ul style="list-style-type: none"> <li>• <b>P</b> control (Proportional component, proportion of the absolute deviation)</li> <li>• <b>I</b> control (Integral component, proportion of the sum of all deviations)</li> <li>• <b>D</b> control (Differential component, proportion of the last difference)</li> </ul>
<p>With pure P controllers (controller type <b>P</b>), the following described settings do not have any function. If needed, the most suitable combination for the respective control system can be determined from these proportions.</p>	
 <p>KP</p>	<p><b>P-component = reaction time</b>                  Setting range: 0 - 200 %                  smaller = more slowly                  bigger = faster</p>
 <p>KI</p>	<p><b>I-component = accuracy, correction time</b>                  Setting range: 0 - 200 %                  bigger = faster                  smaller = more slowly</p>
 <p>KD</p>	<p><b>D-component</b>                  More “D-component” causes more stability by a clean actual value signal with shorter correction times                  By a actual value signal with a superposition should be done to attitude without “D-component” → 0 %                  Setting range: 0 - 200 %                  value smaller = less “D-component”                  value higher = more “D-component”</p>
 <p>TI</p>	<p><b>Integration time = correction time</b>                  Setting range: 0 - 200 %                  smaller = faster                  bigger = more slowly</p>

**9.9.10 Data on the total control deviation**

The total control deviation is comprised of the sum of the control deviations for performance quantities and work quantities combined and refers to the specified areas.

In direct reference to the acquired input and controlled variables, the maximum deviation to the target value is <math>\lt; \pm 5 \%</math>. By activating the menu-assisted adjustment, the total control deviation can be reduced to a value of <math>\lt; \pm 1 \%</math>.

For indirect reference of the acquired input value to the controlled variable, i.e., two physical variables still need to be converted, the deviation can be reduced to <math>\lt; \pm 5 \%</math> through adjustment.

In the case of an internal default value through the integrated or external terminal, the control deviation remains at <math>\lt; \pm 0.5\%</math>.

### 9.10 IO Setup

#### 9.10.1 Analog-Output “A”

	The analog outputs 0 - 10 V can be allocated with various functions. Terminals “A” - “GND” = Analog Out ( $I_{max}$ 10 mA)
	With the attitudes “A min” and “A max” the characteristic of the output voltage can be adapted. Setting range: “A min.” = 0 - 5 V, “A max.” = 10 - 5 V Factory setting: “A min.” = 0 V, “A max.” = 10 V
	With the attitudes “A Inverting” the output voltage can be inverted. Factory setting: “A Inverting” = “OFF”

Function	Description
OFF	without function
1A	Constant voltage +10 V (factory setting)
2A	Proportional the internal control of modulation with consideration “Min. speed” and “Max. speed” setting. <ul style="list-style-type: none"> <li>for enable “OFF” it goes back to 0 V</li> <li>for motor fault the output signal remains for a slave controller (“Master-Slave” combination).</li> </ul>
3A	proportional input “E1”
4A	proportional input “E2”
5A	Group control (☞ Controller Setup - second group)
6A	Control output 2 increasing modulation at actual value > Set = cooling (only mode <b>2.03</b> temperature controller with additional functions).
7A	Control output 2 increasing modulation at actual value < Set (Heating) only mode <b>2.03</b> temperature controller with additional functions).

A1 Function “A min.” and “A max.”

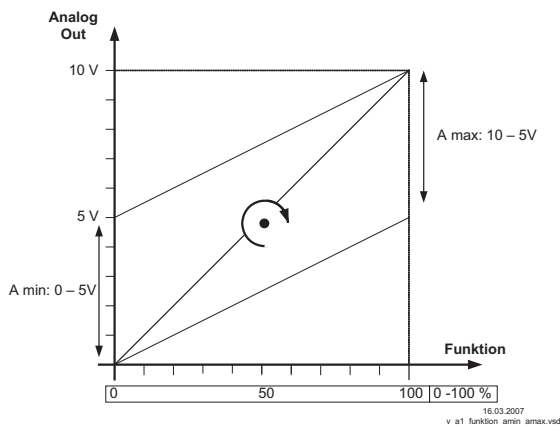

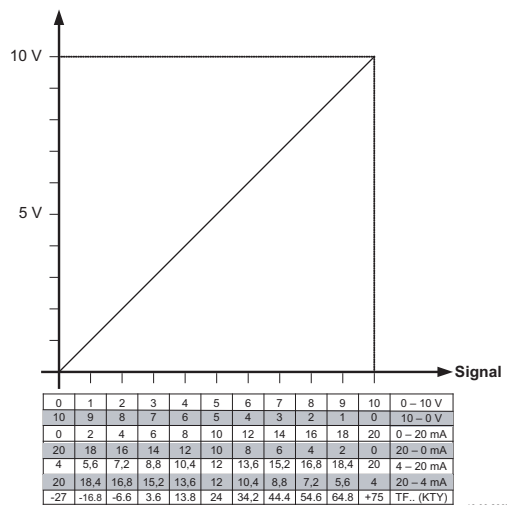

A1 Function **3A** / **4A**



9.10.2 Digital inputs “D1” / “D2”

9.10.2.1 Menu overview

	<p>The digital inputs Digital In 1 (D1) and Digital In 2 (D2) can be allocated with various functions. Activation via floating contacts (a low voltage of approx. 24 V DC is connected).</p>
	<p>Inverting “D1” and “D2” possible</p>
	<p>With networking the digital inputs can be replaced by control over bus. With mode of operation <b>4.03</b> pre-setting of “D1” and “D2” is <input type="checkbox"/> ON.</p>



**Attention!**

**Never apply line voltage to the digital input!**

Function	Description
OFF	No function (factory setting)
1D	Enable (remote control) “ON” / “OFF”
2D	External error
3D	“Limit” ON / OFF
4D	Switch over “E1” / “E2”
<b>For mode speed controller 1.01</b>	
5D	Switch over “Setpoint Intern1” / “Setpoint Intern2”
6D	Switch over “Intern” / “Extern”
<b>For modes as controller higher 2.01</b>	
5D	Switch over “Setpoint1” / “Setpoint2”
6D	Switch over “Intern” / “Extern”
7D	Switch over “automatic control” / “Speed manual”
8D	Switch over control function (e.g. “heating” / “cooling”)
10D	“Reset”
11D	Setting Max. Speed “ON” / “OFF”
12D	Motorheating ON / OFF (not for 1~ voltage controller)
13D	Switch over direction of rotation “clockwise” / “counterclockwise” (only frequency inverter with 3 ~ output)
14D	“Freeze function” = maintain momentary modulation value

**9.10.2.2 Enable ON/OFF function [1D]**

Remote ON/OFF (electronic disconnection) and Reset after a motor malfunction via floating contact. The power section is electronically disconnected. Operation of the device is still possible after pressing the “Esc” hotkey combination in switched-off condition. Signal- in and outputs remain active.

- A programmed operating indicator relay (factory set “K1 function” = [1K]) reports the switch-off.
- A programmed alarm relay (factory set “K2 function” = [2 K]) does not report the switch-off.

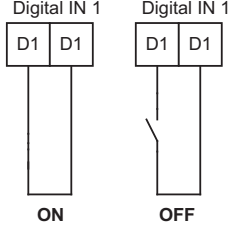
	<p><b>Display STOP for switch OFF</b></p> <ul style="list-style-type: none"> <li>• Controller “ON” for closed contact (factory setting).</li> <li>• Controller “OFF” with opened contact</li> </ul> <p>When inverting in reverse i.e. equipment “OFF” with closed contact.</p>	 <p>10.05.2007 v_1d_freigabe_d1_d1.vsd</p> <p>Contact at digital input e.g. “Digital In 1”</p>
---	--	---



**Attention!**

**No disconnection (isolation) when turned off, in accordance with VBG4 §6!**

**9.10.2.3 External fault Function [2D]**

Connecting an external alarm indication (via floating contact). The device continues to work unchanged during an external indication to the digital input; the alarm symbol appears in the display. This indication can be issued via the relay contacts (K1, K2) (IO Setup function K1, K2). Example for connecting an external alarm indication e.g. to digital input “Digital In 1”

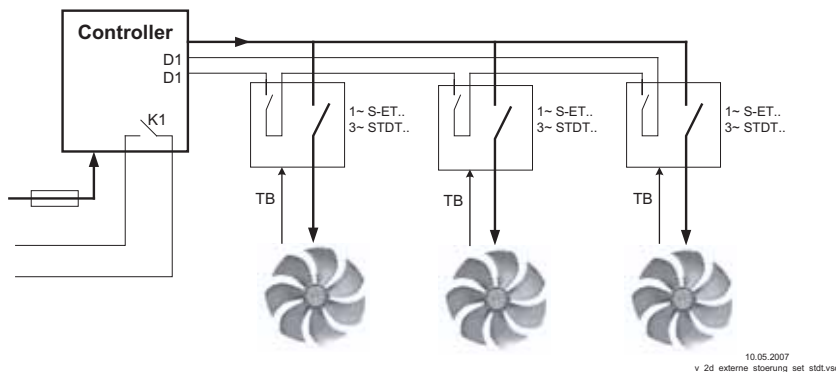

- Indication during closed contact (factory setting): “D1 Inverting” = “OFF ”
- Indication during opened contact: “D1 Inverting” = “ON ”

	<p>Alarm symbol for indication “External fault”</p>
---	---

**9.10.2.4 Limit ON / OFF, Function 3D**

The value for “Limit” adjusted in the Controller Setup, is activated over a digital input. Contact e.g. at digital input “Digital In 1” (depending on device type at terminals “D1” - “D1” or “D1” - “24 V”). For “D1” Inverting “OFF”, limitation active at closed contact.

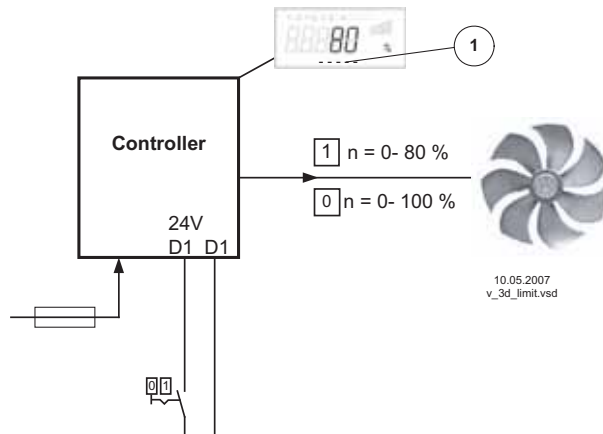

1 Setting “Limit” (depending on device type in: %, Hz, rpm)

**9.10.2.5 Switch over Input signal “E1” / “E2”, Function 4D**

Switch over between Input signal 1 (Analog In 1 terminal “E1”) and input signal 2 (Analog In 2 terminal “E2”). Contact e.g. at digital input “Digital In 1” (depending on device type at terminals “D1” - “D1” or “D1” - “24 V”).

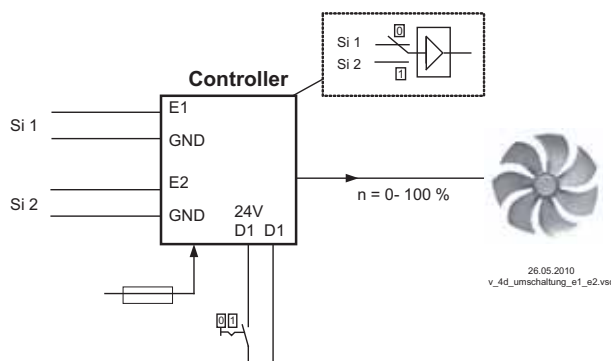

Si 1 Signal 1  
Si 2 Signal 2

For mode speed controller (1.01) Base setup for “E2 Analog In”: 1E necessary.  
For modes controller (higher 2.01 ..) Base setup for “E2 Analog In”: 7E necessary (as far as otherwise does not occupy).

**9.10.2.6 Set 1/2 or Setpoint 1/2, Function 5D**

Switch over between “Set Intern1” and “Set Intern2” (for speed controller 1.01) Contact e.g. at digital input “Digital In 1” (depending on device type at terminals “D1” - “D1” or “D1” - “24 V”).

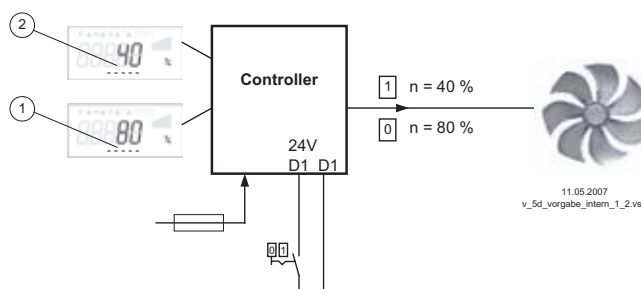

1 Setting “Set Intern1” (depending on device type in: %, Hz, rpm)  
2 Setting “Set Intern2” (depending on device type in: %, Hz, rpm)

- “D1 Inverting” = “OFF”: “Set Intern1” at opened contact / “Set Intern2” at closed contact.
- “D1 Inverting” = “ON”: “Set Intern1” at closed contact / “Set Intern2” at opened contact.



	<p>Operation with “Set Intern2” is signaled by the moon symbol for reduced operation. “Set extern1” under “settings” must be programmed to “OFF”.</p>
---	---

**Switch over between “Setpoint1” and “Setpoint2”** (for modes as controller higher **2.01**)

Contact e.g. at digital input “Digital In 1” (depending on device type at terminals “D1” - “D1” or “D1” - “24 V”).

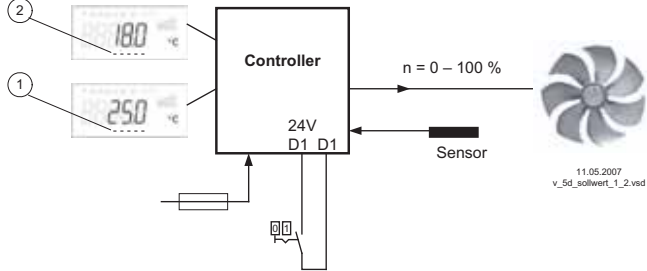

1 Setting “Setpoint1”  
2 Setting “Setpoint2”

- “D1 Inverting” = “OFF”: “Setpoint1” = 18 °C at opened contact / “Setpoint2” = 25 °C at closed contact.
- “D1 Inverting” = “ON”: “Setpoint1” = 18 °C at closed contact / “Setpoint2” = 25 °C at opened contact.

	<p>Operation with “Setpoint2” is signaled by the moon symbol for reduced operation.</p>
---	---

**9.10.2.7 Intern / Extern Function [6D]**

**Switch over between Set Intern and Set Extern** (for mode speed controller **1.01**). “Set extern1” under settings must be programmed to “OFF”.

Contact e.g. at digital input “Digital In 1” (depending on device type at terminals “D1” - “D1” or “D1” - “24 V”).

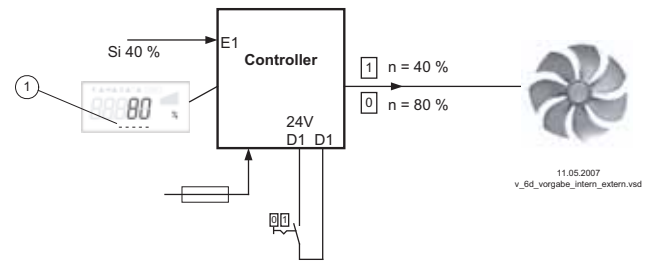

Si Signal  
1 Setting “Set Intern1” (depending on device type in: %, Hz, rpm)

- “D1 Inverting” = “OFF”: “Set Intern1” at opened contact / “Setting Extern” at closed contact.
- “D1 Inverting” = “ON”: “Set Intern1” at closed contact / “Set Extern” at opened contact.

**“Setpoint1” / “external Setpoint”** (modes **2.01**)

Under Base setup “E2 function” programmed to function **[1E]** for “external setpoint” .

Contact at digital input e.g. “Digital In 1” = “D1” - “D1”

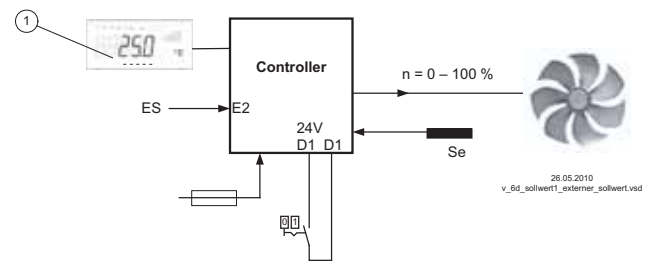

1 Setting “Setpoint1”  
ES External Setpoint e.g. 5 V Δ 23.8°C  
Se Sensor

- “D1 Inverting” = “ON”: Setting at the unit at opened contact / Signal Extern at closed contact
- “D1 Inverting” = “OFF”: Setting at the unit at closed contact / Signal Extern at opened contact

**9.10.2.8 Automatic control / speed manual, Function [7D] (mode 2.01)**

Switch over between automatic control to set target value (depending on the activation: “Setpoint1”, “Setpoint2”) and the default for “manual operation” set at the device.  
 If for Analog In 2 “E2 function” is programmed to [2E] switch over between “Setpoint1” or “Setpoint2” and external manual operation. With activated manual mode the display constantly changes between “actual value” and value for “manual mode”.  
 Contact at digital input e.g. “Digital In 1”

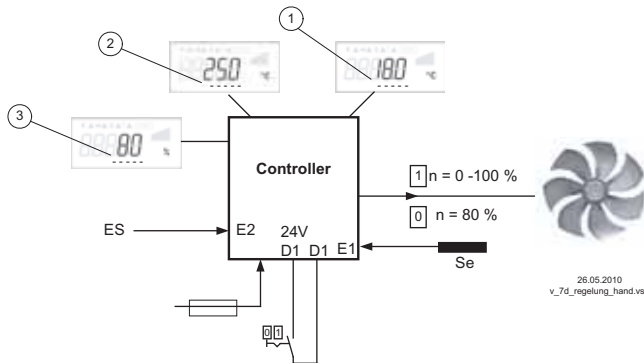

- 1 Setting “Setpoint1”
- 2 Setting “Setpoint2”
- 3 Setting “Speed manual” (depending on device type in: %, Hz, rpm)
- EH Signal for Manual mode extern, E2 Function = [2E]
- Se Sensor

- “D1 Inverting” = “OFF” Automatic control at opened contact / manual operation at closed contact.
- “D1 Inverting” = “ON”: Automatic control at closed contact / manual operation at opened contact.

**9.10.2.9 Reverse action of control function (2.01), Function [8D]**

Switchover between: Increasing modulation during increasing actual-value and increasing modulation during sinking actual-value.  
 The factory presets for the “Control function” are dependent on the selected mode of operation (☞ Controller Setup - reverse operation of the control function).  
 When switching over via a digital input, the device works with the opposite function than the one set there!

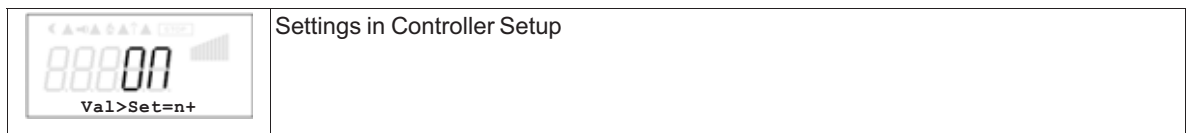

**9.10.2.10 Reset, Function [10D]**

Reset after motor fault by using a non-locking reset key. The unit switches off when interruption between both “TB/TP” or “TK/PTC” terminals, the unit then remains switched off (“motor fault” see ☞ motor protection). Re-starting after the drive has cooled down (terminals “TB/TP”- or “TK/PTC” bridged) by non-locking reset key possible.

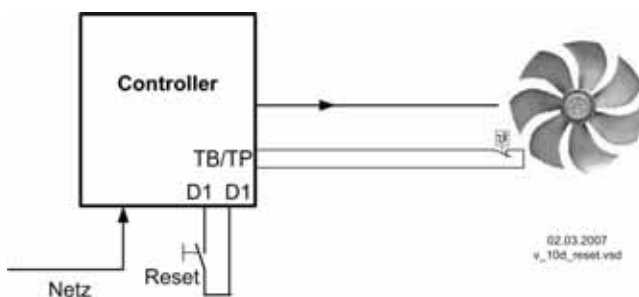

Contact at digital input e.g. “Digital In 1”

- For “D1 Inverting” = “OFF” both terminals “D1”- “D1” in normal operation interrupted. Reset after fault by short close.(For“Inverting” = “ON” reverse function).

**9.10.2.11 Setting Max. Speed ON / OFF function [11D]**

The value for “Max Speed” adjusted in menu “Settings”, is activated over a digital input. I.e. the unit works independently of the controller function firm with this value.  
 Contact e.g. at digital input “Digital In 1” (depending on device type at terminals “D1” - “D1” or “D1” - “24 V”).

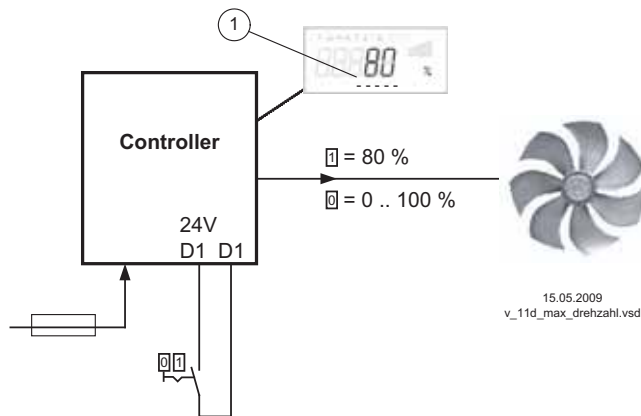

- “D1 Inverting” = “OFF”: “Max. Speed” active at closed contact
- “D1 Inverting” = “ON”: “Max. Speed” active at opened contact

1 Setting “Max. Speed” (depending on device type in: %, Hz, rpm)

**9.10.2.12 Motorheating ON / OFF, Function [12D]**

In order to avoid a sticking or a freezing of standing fans in cold environment, the “motor heating system” can be switched on.

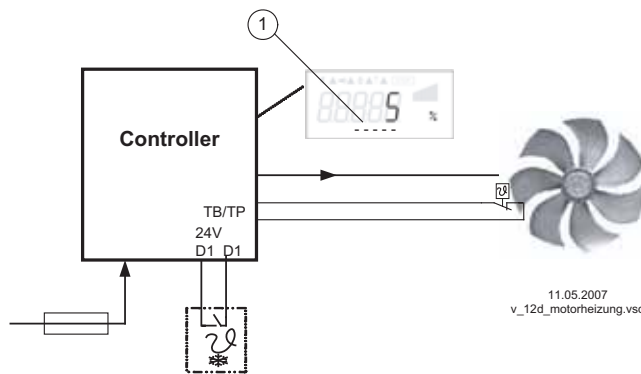

The motor heating can be activated over a digital input.

E.g. over a freeze protection thermostats at digital input “Digital In 1” (depending on device type at terminals “D1” - “D1” or “D1” - “24 V”).

1 Setting “dc brake level”

Motor heating automatically active at closed contact, if no modulation of the controller is present (for “D1” = Inverting “OFF”)

The motor heating function corresponds to the braking function in which a direct current puts the motor into standstill. The height of the “brake level” is set in “Motor Setup”.

Setting range: 1 - 50 %

Factory setting: 5 %

This impresses a current that cannot cause the fan to rotate. The required voltage to prevent freezing depends on the ambient conditions and the technical data of the connected motors. Test the settings you have made under realistic conditions. The higher the output voltage adjustment, the greater the arising heating output (power loss) in the motor. The „motor heating“ or „standstill motor heating “ can only be active if no modulation is present due to closed-loop control. The motor heating can also be activated through the enable function (function [1D] for a digital input) during shutdown. To exclude overheating, motor protection is required through the temperature monitor integrated in the motor (Motor protection). The heating function is shut down if the motor protection function in the controller is activated.

	The activated motor heating is indicated alternating with the actual value
--	--

**9.10.2.13 Direction of rotation, Function 13D**

Switch over “clockwise” rotation and “counterclockwise” rotation. When switching over via a digital input, the device works with the opposite function than the one set in motorsetup.



**Information**

If the rotary direction is reversed with an available modulation, it is initially reduced to “0” (disconnected) and subsequently increased back to the default value.

	<p>The active switch over of direction is indicated by the antenna symbol in the display.</p>
--	---

Contact e.g. by digital input “Digital In 1” for factory setting “ clockwise rotation.”

“D1 Invertierung” = “OFF”: “Clockwise” at opened contact / “Counterclockwise” at closed contact.

“D1 Invertierung” = “ON ”: “Counterclockwise” at opened contact / “Clockwise” at closed contact.

**9.10.2.14 “Freeze function” = maintain momentary modulation value, Function 14D**

The device continues to work so long independently of the controller function with the momentary value of the modulation and / or speed as activated over the digital input.

	<p>Message indicated alternating with the active value “Freeze Function”</p>
--	--

Contact at digital input e.g. “Digital In 1”

“D1 Inverting” = “OFF”: “Freeze function” at closed contact activ

“D1 Inverting” = “ON”: “Freeze function” at opened contact activ

**9.10.3 Inverting analog inputs “E1” / “E2”**

After programming the signal or sensor type, an inversion of the inputs can be carried out.



Factory setting for Inverting inputs = “OFF” (if input activated) (signal: 0 - 10 V, 0 - 20 mA, 4 - 20 mA).

For activation using inverted default signals or sensors with inverted output signals proportional to the measurement range, switch inverting to “ON” (Signal: 10 - 0 V, 20 - 0 mA, 20 - 4 mA).



Example: mode **1.01** speed controller, setting by external signal

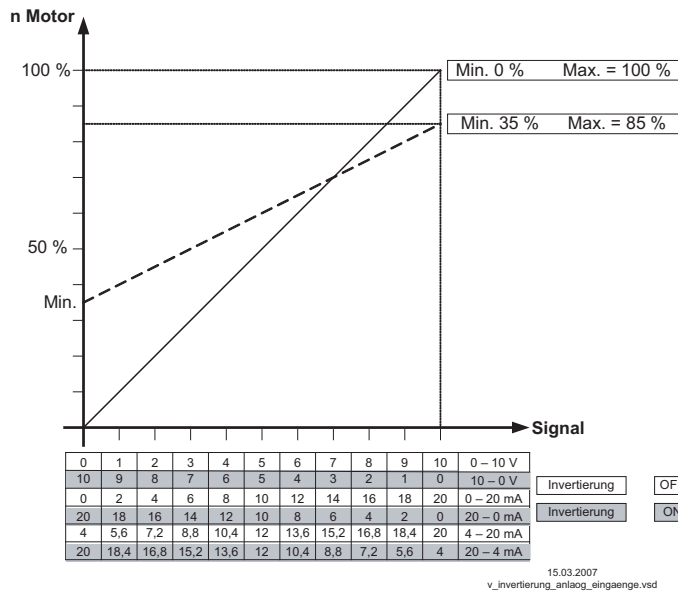

nM Motor speed  
Si Signal  
OFF Inverting = OFF  
ON Inverting = ON

**9.10.4 Function and inverting for relay outputs “K1” and “K2”**

<p>K1 Function</p>	<p>Various functions can be allocated to the relay outputs “K1” and “K2”. In case of the same function allocation for “K1” and “K2”, these work parallel.</p> <p>The factory preset is the inversion of relay “K1” and “K2” to “OFF” (if a function has been programmed).</p>
<p>K1 Inverting</p>	<p>Switch to “ON” for inversion (switch-time response depends on the allocated function). Fundamentally, the relays can only become operative if the electronic’s voltage supply is functioning. At least 2 current phases must be present!</p>
<p>K2 Function</p>	
<p>K2 Inverting</p>	

Function	Description
OFF	No function Relays remain always de-energized
1K	Operating indication (factory setting for “K1”, non inverting). Operation without fault, reports enable “OFF”
2K	Fault indication (factory setting for “K2”, non inverting). Energized for operation without fault, for enable “OFF” not energized. De-energized at line, motor and controller fault, Sensor fault dependent on programming, external fault at digital input.
3K	External fault separate with message at digital input (factory setting if terminals bridged)
4K	Limit modulation Over or falling below limits for modulation
5K	Limit “E1” When over or falling below limits for input signal “E1”
6K	Limit “E2” When over or falling below limits for input signal “E2”

**For modes as controller higher 2.01**

<b>7K</b>	Setpoint Offset Deviation between actual value and setpoint to high
<b>8K</b>	Group control Switching on fans depending on modulation
	<b>For modes as temperature controller with additional functions 2.03</b>
<b>9K</b>	Heating function Switch ON point: temperature = Setpoint +/- Offset Switch OFF point: Temperature around hysteresis over switch ON point
<b>10K</b>	Cooling function Switch ON point: temperature = Setpoint +/- Offset Switch OFF point: Temperature around hysteresis below switch ON point

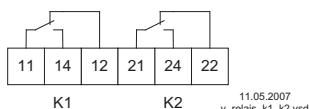

- K1** 1 = energized, terminals 11-14 bridged  
 0 = de-energized, terminals 11-12 bridged
- K2** 1 = energized, terminals 21-24 bridged  
 0 = de-energized, terminals 21-22 bridged

Function	Controller status	K1/ K2	
		1 = energized 0 = de-energized	
		Inverting	
		OFF	ON
<b>1K</b>	Operation without fault, line supply okay	1	0
<b>2K</b>	Fault with indication by relay	0	1
<b>3K</b>	Ext. Fault at digital input for external fault	1	0
<b>4K</b>	Over or falling below limits for modulation	1	0
<b>5K</b>	over or falling below limits for input signal "E1"	1	0
<b>6K</b>	over or falling below limits for input signal "E2"	1	0
<b>7K</b>	setpoint deviation to high	1	0
<b>8K</b>	Switching on second group	1	0

**9.10.5 Programming Add-on module type Z-Modul-B**

Program the additional inputs and outputs likewise in "IO Setup".

After connecting the module, the settings menus are automatically expanded to include the additional inputs and outputs.

- 1 x analog input 0 - 10 V. For mode **1.01** without function, starting from **2.01** funktion **1E** or **2E** possible.
  - Function **1E** for external target value function.
  - Function **2E** for external manual operation.
- 1 x output 0 - 10 V (A2 / GND), Function programmable, e.g., for: Fixed voltage, proportional level control, proportional input signal, group control, drive 2.
- 3x digital inputs (D3 / GND, D4 / GND, D5 / GND) function programmable, e.g.: Enable (ON / OFF), external malfunction, output limitation, input 1/2, target value 1/2, internal/external preset, controller / manual operation, control-function reversal ("heating" / "cooling").
- 2 x relay outputs ("K3" and "K4") Function programmable, e.g., for: Status signals, alarm indications, external malfunctions at the digital input, level-control threshold, input signal threshold, offset threshold (deviation between current and target value), group control.

Parameter	Factory setting	User Setting
A2 Function	1A	
A2 min.	0.0 V	
A2 max.	10.0 V	
A2 Inverting	OFF	
D3 Function	OFF	
D3 Inverting	----	
D4 Function	OFF	
D4 Inverting	----	
D5 Function	OFF	
D5 Inverting	----	
E3 Function	OFF	
E3 Inverting	----	
K3 Function	OFF	
K3 Inverting	----	
K4 Function	OFF	
K4 Inverting	----	

**Z-Modul-B**

max. Kontaktbelastung 5A/250VAC

04.04.2007  
v\_moes@110.VSD

Programming of following functions of mode **2.03** is not permissible on Z-Modul-B: **6A**, **7A**, **9K**, **10K**

**9.10.6 Network by MODBUS®**

It is possible to network several devices with each other. The device uses the MODBUS-RTU as the protocol for the RS-485 interface.

The device address (Device-ID) is factory set to the highest available MODBUS address: 247

This address is reserved for operation with an external terminal model AXG.. and should not be occupied with anything else.





	<p><b>Bus Address</b></p> <p>The addresses of the individual units must be continuously numbered beginning with "1". No address may be allocated twice. MODBUS address adjustable from 1-247. Address 247 = preprogrammed for an external terminal.</p>
	<p><b>Addressing</b></p> <p>Switch addressing to "ON" before setting "address".</p>

**Reading and writing parameters**

The device supports reading and writing processes for Modbus® Holding Registers (3). The start address is 1,; the number of registers depends on the device. If the allowable start address or number is exceeded, the device answers with an exception code. The description of the register is device dependent and can be requested from service for the device/version concerned.

### 9.11 Limits

#### 9.11.1 Limit indication depending on modulation

	Following functions can be allocated to the limit indication	
	OFF	without function
	1L	Indication with the centralized fault of a programmed relay (IO allocation Function [2K]). Warning symbol in display, "AL" code in events memory.
	2L	Is merely displayed in the events menu as message "msg".
In the IO setup, a separate relay can be allocated independent of these settings.		
	If the modulation exceeds the set "Level max" value, this is reported until the set value "Level min" has been undercut. The indication is delayed by the time set in "Display delay".	
		
	Time delay exceeding "Level max." up to indication by relay and alarm symbol. Setting range: 0 - 120 sec. Factory setting: 2 sec.	

#### Example indication by relay "K1":

##### not inverted

IO Setup: K1 Function = 4K  
IO Setup: K1 Inverting = OFF

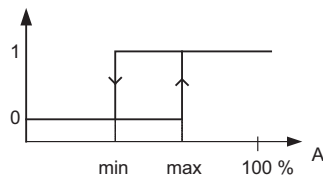

##### Inverting

IO Setup: K1 Function = 4K  
IO Setup: K1 Inverting = OFF

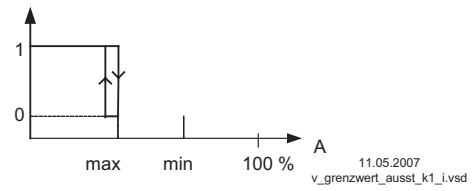
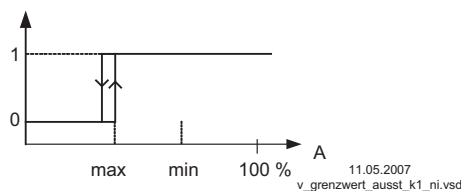
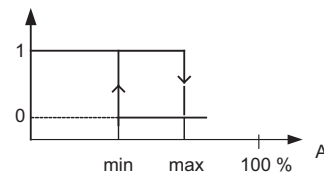

A Modulation

A Modulation

If "Level min." is higher than "Level max.", the "Level max." switching point is without hysteresis!

#### 9.11.2 Limit indication depending on setting or sensor signal

	Following functions can be allocated to the limit indication	
	OFF	without function
	1L	Indication with the centralized fault of a programmed relay (IO allocation Function [2K]). Warning symbol in display, "AL" code in events memory.
	2L	Is merely displayed in the events menu as message "msg".
In the IO setup, a separate relay can be allocated independent of these settings.		



	<p>Both values for E1 (“E1 min” and “E1 max”) can be set independent of each other and act on a relay together if correspondingly programmed. If a function is activated or if a relay is allocated, both settings (“min” and “max”) are initially at “OFF”. Work can be carried out with one as well as with both limit indicators.</p>
	<p>The same setting applies to “E2 Min.” and “E2 Max.”, described below for “E1”. <b>Undercutting the signal (“E1 min”).</b> If the signal undercuts the set value “E1 min”, this is reported until the set value (plus adjustable hysteresis) has been exceeded once again.</p>
	<p><b>Exceeding the signal (“E1 max”).</b> If the signal exceeds the set value “E1 max”, this is reported until the set value (minus hysteresis) has been undercut once again.</p>
	<p><b>E1 Hysteresis</b> Hysteresis adjustment in the unit of measure of the programmed input signal.</p>
	<p><b>E1 Delay</b> Time delay exceeding “Level max.” up to indication by relay and alarm symbol. Setting range: 0 - 120 sec. Factory setting: 2 sec.</p>



**Information**

Always adjust the value for the maximum input signal higher than the value for the minimum input signal!  
E1 Max. > E1 Min.

**Example for a limit indication of default signal or sensor signal to “Analog In 1”**

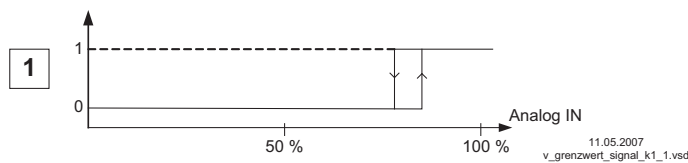

**Settings:**

- E1 Max.: 80 %
- E1 Min.: OFF
- switching hysteresis 5 % (from 100 %)

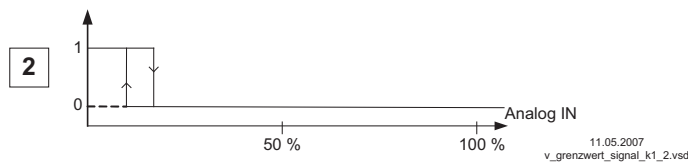

**Settings:**

- E1 Min.: 20 %
- E1 Max.: OFF
- switching hysteresis 5 % (from 100 %)

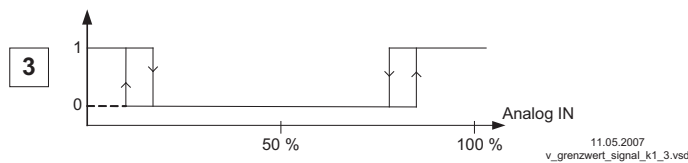





**Settings:**

- E1 Min.: 20 %
- E1 Max.: 80 %
- switching hysteresis 5 % (from 100 %)

Terminal “E1” and “GND” alarm via relay “K1” (non-inverted) IO Setup → K1 function: 5 K = limit indicators

**9.11.3 Limit indication depending on (offset) to Setpoint**

In operating modes as a controller (via **2.01**), two limit indicators can be carried out based on the set target value (Setpoint) and measured actual value (on E1).

	<p>Following functions can be allocated to the limit indication</p> <table border="1"> <tr> <td>OFF</td> <td>without function</td> </tr> <tr> <td>1L</td> <td>Indication with the centralized fault of a programmed relay (IO allocation function [2K]) warning symbol in display, "AL" code in events memory.</td> </tr> <tr> <td>2L</td> <td>Is merely displayed in the events menu as message "msg".</td> </tr> </table> <p>In the IO setup, a separate relay can be allocated independent of these settings.</p>	OFF	without function	1L	Indication with the centralized fault of a programmed relay (IO allocation function [2K]) warning symbol in display, "AL" code in events memory.	2L	Is merely displayed in the events menu as message "msg".
OFF	without function						
1L	Indication with the centralized fault of a programmed relay (IO allocation function [2K]) warning symbol in display, "AL" code in events memory.						
2L	Is merely displayed in the events menu as message "msg".						
	<p><b>Offset 1, Offset 2</b></p> <p>Both values for Offset 1 and Offset 2 can be set independent of each other and act on a relay together if correspondingly programmed. If a function is activated or if a relay is allocated both settings (Offset 1 and Offset 2) are initially at "OFF".</p> <p>Work can be carried out with one as well as with both limit indicators.</p>						
	<p>"Offset 1" for alarm in case of an exceeding of the max. deviation between actual and target.                  Switch ON point: actual value = Setpoint +/- offset                  Switch OFF point: Actual value by hysteresis under the switch-on point</p> <p>"Offset 2" for alarm in case of an undercutting of the max. deviation between actual and target                  Switch ON point: actual value = Setpoint +/- offset                  Switch OFF point: Actual value by hysteresis over the switch-on point</p>						
	<p><b>Offset Hysteresis</b></p> <p>Hysteresis switch-on point: In temperature regulation + / - 10 K, otherwise sensors 10 % of measurement range</p>						
	<p><b>Offset Delay</b></p> <p>Time delay until indication through relay and alarm symbol.                  Setting range: 0 - 120 sec.                  Factory setting: 2 sec.</p>						

Example for temperature regulation; for other modes of operation settings in corresponding sensor unit.

Offset 1 for alarm during exceeding

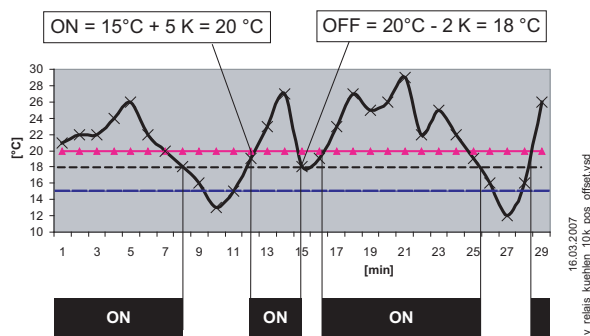

Example: Setpoint 15.0 °C, Offset +5.0 K, Hysteresis 2.0 K

Offset 2 for alarm during undercutting

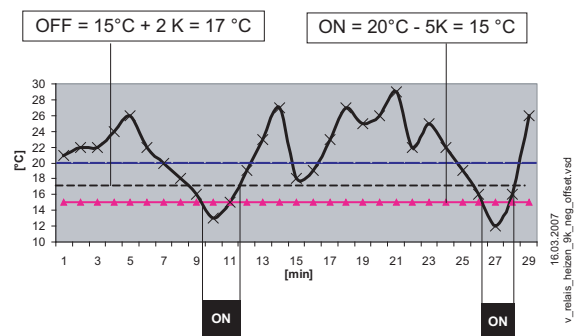

Example: Setpoint 15.0° C, Offset -5.0 K, Hysteresis 2.0 K

## 9.12 Motor Setup

### 9.12.1 Setting motor rated current

	<p><b>MotorRatedCurr.</b>                  Setting for Motor rated current = setpoint of current controller (current limiting).                  Setting range: 0.0...device rated current / A                  Factory setting: device rated current</p>
---	---



### 9.12.2 Setting motor rated voltage

	<p><b>MotorRatedVolt.</b>  <b>When commissioning, you must set the motor to the rated voltage stated on the rating plate.</b>  <b>Caution! Make settings for U/f curve and motor rated voltage only while the motor is not being triggered.</b></p> <p>The output voltage depends on the load. Under load with rated current, this is approx. 3 ~ 230 V (setting 230 V). When the load is lower, the output voltage is higher (approx. 260 V without load). If necessary, the output voltage can be checked with a multimeter and adapted if applicable.</p> <p>Adjustment range: 0...250 V (settings above 250 V do not yield a higher output voltage)                  Factory setting: 230 V</p>
---	---

### 9.12.3 Adjustment of the U/f curve



**Information**  
 The device comes supplied with a preprogrammed square characteristic curve for the operation of fans.  
 In the case of voltage-controllable motors and square load torque-moments (e.g. fans and pump operation), an optimal speed control is generally achieved through this.  
 In systems in which high dynamics are required, switchover to a linear characteristic must take place. Generally speaking, if the load characteristic is not known as a definite value, the linear characteristic should be set. In the case of linear characteristic curves, the motor achieves full torque throughout the entire speed range. For this, a thermal overload of the motor must be prevented through suitable measures (complete motor protection through using thermocontact or PTC thermistor-monitoring).

	<p><b>Edgefrequency</b>                  The maximum output voltage is attained during break edge frequency.                  Adjustment range: 10.0 - 150.0 Hz                  Factory setting: 50.0 Hz</p>
	<p><b>Max. Frequency</b>                  Above the Edgefrequency, the frequency is merely increased up to the Maximum frequency.                  Adjustment range: 10.0 - 150.0 Hz                  Factory setting: 50.0 Hz</p>
	<p><b>Shutdown Freq.</b>                  Below the Shutdown Freq. the output is switched off.                  Adjustment range: 5.0 - 150 Hz                  Factory setting: 5.0 Hz</p>

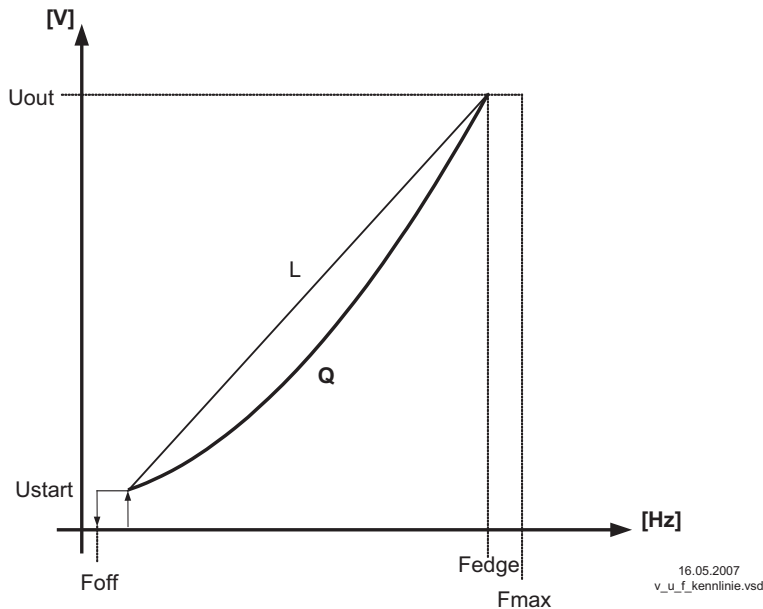

Uout output voltage  
 Ustart Start-up voltage  
 Foff Shutdown Freq.  
 Fedge Edgefrequency  
 Fmax Maximum frequency  
 L linear  
 Q Square (factory setting)

<p>Startvoltage</p>	<p><b>Startvoltage</b>                  The start voltage is used to apply enough torque to the motors to insure they will run at low speed.  <b>Caution!</b> In order to prevent overcurrent and unnecessarily high thermal load of the motor, do not select to high a setting.                  Adjustment range: 0 - 25 % (percentage of the maximum output voltage)                  Factory setting: 0 %</p>
<p>VF quadratic</p>	<p><b>VF quadratic</b>                  U/f curve linear or square                  Factory preprogrammed square characteristic curve "UF square" = "ON" for the operation of voltage controllable fans.                  For operation with linear curve "UF quadratic" = "OFF"</p>

**9.12.4 Setting for Rampup time and Rampdown time**

By separate menus for Rampup time and Rampdown time an adjustment is possible to individual system conditions.

This function is switched behind the actual controller function.

<p>Rampup time</p>	<p><b>Rampup time</b>                  Time setting in which the automatic controller output from 0 % to 100 % rises.                  Setting range: 2...250 sec.                  Factory setting: 10 / 20 / 40 sec. (depending on device type)</p>
<p>Rampdown time</p>	<p><b>Rampdown time</b>                  Time setting in which the automatic controller output from 100 % to 0 % reduces.                  Setting range: 2...250 sec.                  Factory setting: 10 / 20 / 40 sec. (depending on device type)</p>

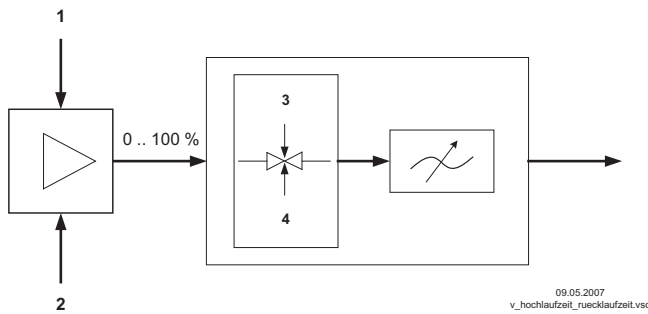

- 1 external Signal
- 2 Setting
- 3 Rampup time
- 4 Rampdown time

**9.12.5 Setting Rolling direct.**



**Attention!**

**It is essential to check the direction of rotation of the fan during the initial commissioning. To do this, note the direction of the arrow on the fan housing. We will not be responsible under any circumstances for warranty for damage caused because the direction of rotation is wrong!**

When connected in accordance with the connection diagram, the standard rotary direction “RIGHT” results under factory settings. A change of direction is feasible by exchanging the phase sequence in the motor connection or through reprogramming.







	<p>By selection of the parameter “Direction of rotation” and following pressing the <b>P</b> key, the direction of rotation can be changed to “L” for anti-clockwise direction of rotation. (factory setting “R”). Pressing the <b>P</b> key causes the value that has been set to be accepted.</p>	
--	---	--

If the rotary direction is reversed with an available modulation, it is initially reduced to “0” (disconnected) and subsequently increased back to the default value.

**9.12.6 Setting Current limit**

	<p>The frequency inverter uses current limitation as an additional safety feature. It can be adapted as necessary. When the motor’s rated current is exceeded by the percentage set here, the modulation is reduced as far as necessary until it has readjusted itself. This prevents overloading the motor. Setting range: 100...200 % Factory setting: 120 %</p>
	<p>Active current limit is signaled by a bright triangle in the display</p>

9.12.7 Setting brake function

 <p>DC brake mode</p>	<p><b>DC brake mode</b>                  Setting function of DC-brake for frequency inverters.                  For units that come with a factory engaged DC brake mode (if extant,  DC brake mode setting), simultaneously activating the “DC brake mode ” only makes sense in exceptional cases.</p> <p><b>0</b> = no brake function (factory setting).  <b>1</b> = brakes before start (before modulation is returned)                  If, under certain circumstances, the modulation switches back on while the motor is still rotating fast, this can result in a re-supply of the inverter’s “overcurrent disconnection”. The brake function can be activated to prevent this. This is then always active for an adjustable period before triggering starts. I.e., the brake function is always initiated before modulation after has it returned to “0”. The suitable adjustments depend on the centrifugal force of the motor and the conditions in the installation.  <b>2</b> = Special function, brakes before stop (as soon as modulation “0”).                  The motor does not run out up to stop. The motor is braked actively, as soon as no modulation is present (Setpoint = “0” or Enable = “OFF”) .</p> <p>Test required. The “min. speed” adjustment must be set to “0”.                  Attention! With the frequently one behind the other following DC bracings it can come to strong heating up of the motor.                  To prevent any overheating, motor protection in the form of a temperature limiter installed in the motor is required ( motor protection).</p>
 <p>DC brake time</p>	<p><b>DC brake time</b>                  Maximal length of DC-brake for frequency inverters.                  If the braking is activated, the d.c. brake torque is active for this time.                  Setting range: 0...250 sec.                  Factory setting: 5 sec.</p>
 <p>DC brake level</p>	<p><b>DC brake level</b>                  Direct-current voltage level, generated for braking. The higher this value, the greater the braking effect. The setting is dependent on the size of the ventilator / motor.                  Attention! Values that are too high, will result in an excessive braking effect and possibly lead to actuation of the overload shutoff.                  Same setting affects also the function “Motorheating” ( IO Setup).                  Setting range: 0...50 %                  Factory setting: 5 %</p>
 <p>Frequency</p>	<p>Active brake mode is signaled by a bright triangle in the display.</p>

9.12.8 Setting Boost value

The boost function is an automatic voltage increase when the control system is under dynamic requirements. When using the square characteristic curve, the output voltage is increased disproportionately to the frequency during a 20% increase of the modulation. That results in more torque on the motor so the current does not increase so strongly during accelerations. Just before reaching the modulation default value, the motor voltage that corresponds to the square characteristic curve is restored. The boost mode is only used during sufficiently large modulation increases (starting from ca. 20 %).

 <p>Boost Value</p>	<p>You can determine the amount of voltage increase via the percentage setting. 15 % boost value increase voltage by 15 % over normal value of the square characteristic curve.                  Setting range: 0...25.0 %                  Factory setting: 15.0 %</p>
--	---

**9.12.9 Setting Derating Alarm and Temperature monitoring**

The device has integrated temperature monitoring to protect the device from damage caused by excessively high interior temperatures.

In case of a temperature increase above the predetermined threshold value the level-control is linearly reduced until the stated threshold temperatures are reached. To prevent a shut down of the entire system (in this operating mode, allowable for the controller), no alarm indication occurs via the relay contacts until the preset threshold value (due to an excessively high interior temperature) is reached during reduced operation!

	<p><b>Derating Alarm</b></p> <p>The factory preset for the “Derating Alarm” is 5 %.</p> <p>I.e. the device level-control due to excessive interior temperatures only amounts to 5 % of the maximum possible. Therefore a message is issued via the programmed operational or indicator relay.</p> <p>Setting range: 1...95 %</p>
---	--

**9.12.10 Suppression of speeds**

Suppression of up to three speed ranges.





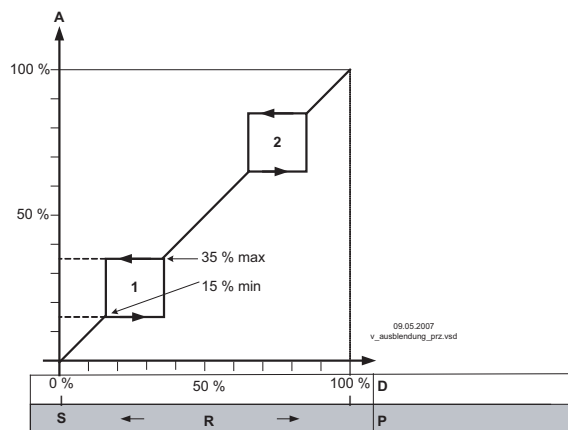

Under certain circumstances, it is possible to prevent disturbing noises that can arise at certain speeds due to resonances.

**Example for suppression of 2 ranges (Idealized principle diagram)**



Setting depending on device type in: %, Hz, rpm

- A Modulation
- S Setpoint
- R Pband
- D Speed controller: setting signal
- P P-controller: control deviation

	<p>→ Factory setting no suppression active = “OFF”</p>	<p>→ </p>
	<p>→ Setting for “Range1 min.”</p>	<p>→ </p>
	<p>→ Setting for “Range1 max.”</p>	<p>→ </p>
	<p>→ Identical procedures for Suppression2 and Suppression3, as far as desired</p>	<p>→ etc.</p>

## 10 Menu tables

### 10.1 Menues of operating modes

Mode	1.01	2.01 2.03 2.04	2.02	2.05	3.01 3.02	3.03 3.04	4.01 4.02 4.03	5.01 5.02	6.01	User Setting
Parameter	Factory setting									
<b>Start</b>										
Motor	OFF	OFF	OFF	OFF	OFF	OFF	OFF	OFF	OFF	
PIN input	-----	-----	-----	-----	-----	-----	-----	-----	-----	
Language	GB	GB	GB	GB	GB	GB	GB	GB	GB	
Reset	OFF	OFF	OFF	OFF	OFF	OFF	OFF	OFF	OFF	
Mode	1.01	2.01 2.03 2.04	2.02	2.05	3.01 3.02	3.03 3.04	4.01 4.02 4.03	5.01 5.02	6.01	
Fcontrol	2.35	2.35	2.35	2.35	2.35	2.35	2.35	2.35	2.35	
SN:	000005- E45536	000005- E45536	000005- E45536	000005- E45536	000005- E45536	000005- E45536	000005- E45536	000005- E45536	000005- E45536	
d1228 B03	11/02/09	11/02/09	11/02/09	11/02/09	11/02/09	11/02/09	11/02/09	11/02/09	11/02/09	
<b>Info</b>										
E1-E2 actual				-2.4 °C						
Control value		2.04 = 30.0 °C				12.0 bar 22.6 °C				
E1 Actual		30.0 °C	30.0 °C	30.0 °C	10.0 bar 9.5 °C	10.0 bar 9.5 °C	88.7 Pa	712 m <sup>3</sup> h	0.45 m/s	
E2 Actual		----- 2.04 = 30.0 °C	-----	30.0 °C	-----	10.0 bar 9.5 °C	----- 4.02, 4.03 = 21.0 °C	----- 5.02 = 21.0 °C	-----	
Setpoint1		20.0 °C	5.0 °C	0.0 °C	12.0 bar 35.0°C	12.0 bar 35.0°C	100 Pa	530 m <sup>3</sup> h	0.50 m/s	
Setpoint control							4.02, 4.03 = 100 Pa	5.02 = 530 m <sup>3</sup> h		
Frequency	0.0 Hz	0.0 Hz	0.0 Hz	0.0 Hz	0.0 Hz	0.0 Hz	0.0 Hz	0.0 Hz	0.0 Hz	
Motor current	0.0 A	0.0 A	0.0 A	0.0 A	0.0 A	0.0 A	0.0 A	0.0 A	0.0 A	
Set external1	0.0 Hz									
Msc0		OFF	OFF	OFF	OFF	OFF	OFF	OFF	OFF	
<b>Setting</b>										
Set Intern1	50.0 Hz									
Set Intern2	-----									
Setpoint1		20.0 °C	5.0 °C	0.0 °C	12.0 bar 35.0°C	12.0 bar 35.0°C	100 Pa	530 m <sup>3</sup> h	0.50 m/s	
Setpoint2		-----	-----	-----	-----	-----	----- 4.03 = 100 Pa	-----	-----	
Pband		5.0 K	20.0 K	5.0 K	5.0 bar 7.0 K	5.0 bar 7.0 K	100 Pa	530 m <sup>3</sup> h	0.50 m/s	
Min. Speed	0.0 Hz	0.0 Hz	0.0 Hz	0.0 Hz	0.0 Hz	0.0 Hz	0.0 Hz	0.0 Hz	0.0 Hz	
Max. Speed	50.0 Hz	50.0 Hz	50.0 Hz	50.0 Hz	50.0 Hz	50.0 Hz	50.0 Hz	50.0 Hz	50.0 Hz	
Set external1	ON									
Manual mode		OFF	OFF	OFF	OFF	OFF	OFF	OFF	OFF	
Speed man.		50.0 Hz	50.0 Hz	50.0 Hz	50.0 Hz	50.0 Hz	50.0 Hz	50.0 Hz	50.0 Hz	



Mode	1.01	2.01 2.03 2.04	2.02	2.05	3.01 3.02	3.03 3.04	4.01 4.02 4.03	5.01 5.02	6.01	User Setting
	Factory setting									
Offset AnalogOut		2.03 = 0.0 K								
Pband AnalogOut		2.03 = 2.0 K								
Min. AnalogOut		2.03 = 0 %								
Max. AnalogOut		2.03 = 100 %								
OffsetDigitalOut		2.03 = -1.0 K								
Hyst.DigitalOut		2.03 = 1.0 K								
Alarm Minimum		2.03 = 0.0 °C								
Alarm Maximum		2.03 = 40.0 °C								
T-Band SA							4.02 + 4.03 = 30.0 K	5.02 = 30.0 K		
T-Start SA							4.02 + 4.03 = 15.0 °C	5.02 = 15.0 °C		
P-Min SA							4.02 + 4.03 = 70.0 Pa	5.02 = 70.0 m <sup>3</sup> h		
<b>Events</b>										
<b>Base setup</b>										
Mode	1.01	2.01 2.03 2.04	2.02	2.05	3.01 3.02	3.03 3.04	4.01 4.02 4.03	5.01 5.02	6.01	
E1 Analog In	0 - 10 V	TF	TF	TF	0-30 MBG	0-30 MBG	DSG200	DSG200	0-1 MAL	
E1 Refrigerant					3.02 = R503	3.04 = R503				
E1 K-Factor								75		
E1 Min.		-----	-----	-----	-----	-----	-----	-----	-----	
E1 Max.		-----	-----	-----	-----	-----	-----	-----	-----	
E1 Decimals		-----	-----	-----	-----	-----	-----	-----	-----	
E1 Unit		-----	-----	-----	-----	-----	-----	-----	-----	
E1 Offset		0.0 K	0.0 K	0.0 K	0.00 bar 0.0 K	0.00 bar 0.0 K	0.0 Pa	0.0 Pa	0.0 m/s	
E2 Function	OFF	OFF 2.04 = 4E	OFF	5E	OFF	4E	OFF 4.02 + 4.03 = 6E	OFF 5.02 = 6E	OFF	
E2 Analog In	-----	----- 2.04 = TF	-----	TF	-----	0-30 MBG	----- 4.02 = TF 4.03 = Bus	----- 5.02 = TF	-----	
E2 Refrigerant					3.02 = -- ---	3.04 = R503				

Mode	1.01	2.01 2.03 2.04	2.02	2.05	3.01 3.02	3.03 3.04	4.01 4.02 4.03	5.01 5.02	6.01	User Setting
	Factory setting									
E2 K-Factor								5.01 = 75		
E2 Min.		-----	-----	-----	-----	-----	----- 4.03 = -35.0 °C	-----	-----	
E2 Max.		-----	-----	-----	-----	-----	----- 4.03 = 65.0 °C	-----	-----	
E2 Decimals		-----	-----	-----	-----	-----	----- 4.03 = 1	-----	-----	
E2 Unit		-----	-----	-----	-----	-----	----- 4.03 = °C	-----	-----	
E2 Offset		----- 2.04 = 0.0 K	-----	0.0 K	-----	0.00 bar 0.0 K	----- 4.02 + 4.03 = 0.0 K	----- 5.02 = 0.0 K	-----	
<b>Controller Setup</b>										
PIN Protection	OFF	OFF	OFF	OFF	OFF	OFF	OFF	OFF	OFF	
Set protection	OFF	OFF	OFF	OFF	OFF	OFF	OFF	OFF	OFF	
Save User Setup	OFF	OFF	OFF	OFF	OFF	OFF	OFF	OFF	OFF	
Alarm sensors		OFF	OFF	OFF	OFF	OFF	OFF	OFF	OFF	
Limit	-----	-----	-----	-----	-----	-----	-----	-----	-----	
Msc0.		OFF	OFF	OFF	OFF	OFF	OFF	OFF	OFF	
Group 2 ON value	-----	-----	-----	-----	-----	-----	-----	-----	-----	
nmin at Group2	-----	-----	-----	-----	-----	-----	-----	-----	-----	
Val > Set=n+		ON	ON	ON	ON	ON	OFF	OFF	OFF	
Type of control		P	P	P	P	P	Pid	Pid	Pid	
KP		50 %	50 %	50 %	50 %	50 %	50 %	50 %	50 %	
KI		50 %	50 %	50 %	50 %	50 %	50 %	50 %	50 %	
KD		50 %	50 %	50 %	50 %	50 %	50 %	50 %	50 %	
TI		0 %	0 %	0 %	0 %	0 %	0 %	0 %	0 %	
<b>IO Setup</b>										
A Function	1A	1A (2.03 = 6A)	1A	1A	1A	1A	1A	1A	1A	
A min.	0.0 V	0.0 V	0.0 V	0.0 V	0.0 V	0.0 V	0.0 V	0.0 V	0.0 V	
A max.	10.0 V	10.0 V	10.0 V	10.0 V	10.0 V	10.0 V	10.0 V	10.0 V	10.0 V	
A Inverting	OFF	OFF	OFF	OFF	OFF	OFF	OFF	OFF	OFF	
A2* Function	1A	1A	1A	1A	1A	1A	1A	1A	1A	
A2* min.	0.0 V	0.0 V	0.0 V	0.0 V	0.0 V	0.0 V	0.0 V	0.0 V	0.0 V	
A2* max.	10.0 V	10.0 V	10.0 V	10.0 V	10.0 V	10.0 V	10.0 V	10.0 V	10.0 V	
A2* Inverting	OFF	OFF	OFF	OFF	OFF	OFF	OFF	OFF	OFF	
D1 Function	OFF	OFF	OFF	OFF	OFF	OFF	OFF 4.03 = 1D	OFF	OFF	
D1 Inverting	-----	-----	-----	-----	-----	-----	----- 4.03 = OFF	-----	-----	

Mode	1.01	2.01 2.03 2.04	2.02	2.05	3.01 3.02	3.03 3.04	4.01 4.02 4.03	5.01 5.02	6.01	User Setting
	Factory setting									
D1 Busmode	-----	-----	-----	-----	-----	-----	----- 4.03 = ON	-----	-----	
D2 Function	OFF	OFF	OFF	OFF	OFF	OFF	OFF 4.03 = 5D	OFF	OFF	
D2 Inverting	-----	-----	-----	-----	-----	-----	----- 4.03 = OFF	-----	-----	
D2 Busmode	-----	-----	-----	-----	-----	-----	----- 4.03 = ON	-----	-----	
D3* Function	OFF	OFF	OFF	OFF	OFF	OFF	OFF	OFF	OFF	
D3* Inverting	-----	-----	-----	-----	-----	-----	-----	-----	-----	
D4* Function	OFF	OFF	OFF	OFF	OFF	OFF	OFF	OFF	OFF	
D4* Inverting	-----	-----	-----	-----	-----	-----	-----	-----	-----	
D5* Function	OFF	OFF	OFF	OFF	OFF	OFF	OFF	OFF	OFF	
D5* Inverting	-----	-----	-----	-----	-----	-----	-----	-----	-----	
E1 Inverting	OFF	OFF	OFF	OFF	OFF	OFF	OFF	OFF	OFF	
E2 Inverting	-----	----- 2.04 = OFF	-----	OFF	-----	OFF	----- 4.02 + 4.03 = OFF	----- 5.02 = OFF	OFF	
E3* Function	OFF	OFF	OFF	OFF	OFF	OFF	OFF	OFF	OFF	
E3* Inverting	-----	-----	-----	-----	-----	-----	-----	-----	-----	
K1 Function	1K	1K (2.03 = 2K)	1K	1K	1K	1K	1K	1K	1K	
K1 Inverting	OFF	OFF	OFF	OFF	OFF	OFF	OFF	OFF	OFF	
K2 Function	2K	2K (2.03 = 9K)	2K	2K	2K	2K	2K	2K	2K	
K2 Inverting	OFF	OFF	OFF	OFF	OFF	OFF	OFF	OFF	OFF	
K3* Function	OFF	OFF	OFF	OFF	OFF	OFF	OFF	OFF	OFF	
K3* Inverting	-----	-----	-----	-----	-----	-----	-----	-----	-----	
K4* Function	OFF	OFF	OFF	OFF	OFF	OFF	OFF	OFF	OFF	
K4* Inverting	-----	-----	-----	-----	-----	-----	-----	-----	-----	
Bus Address	247	247	247	247	247	247	247	247	247	
Addressing	OFF	OFF	OFF	OFF	OFF	OFF	OFF	OFF	OFF	
<b>Limits</b>										
Level Function	OFF	OFF	OFF	OFF	OFF	OFF	OFF	OFF	OFF	
Level min.	-----	-----	-----	-----	-----	-----	-----	-----	-----	
Level max.	-----	-----	-----	-----	-----	-----	-----	-----	-----	
Level Delay	-----	-----	-----	-----	-----	-----	-----	-----	-----	
Lmt E1 Function	OFF	2.03 = 1L	OFF	OFF	OFF	OFF	OFF	OFF	OFF	
Lmt E1 min	-----	2.03 = 0.0 °C	-----	-----	-----	-----	-----	-----	-----	
Lmt E1 max.	-----	2.03 = 40.0 °C	-----	-----	-----	-----	-----	-----	-----	
Lmt E1 Hyst.	-----	2.03 = 1.0 K	-----	-----	-----	-----	-----	-----	-----	
Lmt E1 Del.	-----	2.03 = 2 sec.	-----	-----	-----	-----	-----	-----	-----	

Mode	1.01	2.01 2.03 2.04	2.02	2.05	3.01 3.02	3.03 3.04	4.01 4.02 4.03	5.01 5.02	6.01	User Setting
	Factory setting									
Lmt E2 Function	-----	2.03 = OFF	-----	-----	-----	-----	-----	-----	-----	
Lmt E2 min.	-----	-----	-----	-----	-----	-----	-----	-----	-----	
Lmt E3 max.	-----	-----	-----	-----	-----	-----	-----	-----	-----	
Lmt E2 Hyst.	-----	-----	-----	-----	-----	-----	-----	-----	-----	
Lmt E2 Del.	-----	-----	-----	-----	-----	-----	-----	-----	-----	
Offset Function		OFF	OFF	OFF	OFF	OFF	OFF	OFF	OFF	
Offset 1		-----	-----	-----	-----	-----	-----	-----	-----	
Offset 2		-----	-----	-----	-----	-----	-----	-----	-----	
Offset Hyst.		-----	-----	-----	-----	-----	-----	-----	-----	
Offset Del.		-----	-----	-----	-----	-----	-----	-----	-----	
<b>Motor Setup</b>										
MotorRatedCurr.	6.0 A	6.0 A	6.0 A	6.0 A	6.0 A	6.0 A	6.0 A	6.0 A	6.0 A	
MotorRatedVolt.	230 V	230 V	230 V	230 V	230 V	230 V	230 V	230 V	230 V	
Edgefrequency	50.0 Hz	50.0 Hz	50.0 Hz	50.0 Hz	50.0 Hz	50.0 Hz	50.0 Hz	50.0 Hz	50.0 Hz	
Max. Frequency	50.0 Hz	50.0 Hz	50.0 Hz	50.0 Hz	50.0 Hz	50.0 Hz	50.0 Hz	50.0 Hz	50.0 Hz	
Rampup time	40 sec	40 sec	40 sec	40 sec	40 sec	40 sec	40 sec	40 sec	40 sec	
Rampdown time	40 sec	40 sec	40 sec	40 sec	40 sec	40 sec	40 sec	40 sec	40 sec	
Shutdown Freq.	5.0 Hz	5.0 Hz	5.0 Hz	5.0 Hz	5.0 Hz	5.0 Hz	5.0 Hz	5.0 Hz	5.0 Hz	
Startvoltage	0 %	0 %	0 %	0 %	0 %	0 %	0 %	0 %	0 %	
VF quadratic	ON	ON	ON	ON	ON	ON	ON	ON	ON	
Rolling direct.	R	R	R	R	R	R	R	R	R	
Current limit	120 %	120 %	120 %	120 %	120 %	120 %	120 %	120 %	120 %	
DC brake mode	0	0	0	0	0	0	0	0	0	
DC brake time	5 sec	5 sec	5 sec	5 sec	5 sec	5 sec	5 sec	5 sec	5 sec	
DC brake level	5 %	5 %	5 %	5 %	5 %	5 %	5 %	5 %	5 %	
Boost Value	15.0 %	15.0 %	15.0 %	15.0 %	15.0 %	15.0 %	15.0 %	15.0 %	15.0 %	
Derating Alarm	5 %	5 %	5 %	5 %	5 %	5 %	5 %	5 %	5 %	
Suppression1	OFF	OFF	OFF	OFF	OFF	OFF	OFF	OFF	OFF	
Range1 min.	-----	-----	-----	-----	-----	-----	-----	-----	-----	
Range1 max.	-----	-----	-----	-----	-----	-----	-----	-----	-----	
Suppression2	OFF	OFF	OFF	OFF	OFF	OFF	OFF	OFF	OFF	
Range2 min.	-----	-----	-----	-----	-----	-----	-----	-----	-----	
Range2 max.	-----	-----	-----	-----	-----	-----	-----	-----	-----	
Suppression3	OFF	OFF	OFF	OFF	OFF	OFF	OFF	OFF	OFF	
Range3 min.	-----	-----	-----	-----	-----	-----	-----	-----	-----	
Range3 max.	-----	-----	-----	-----	-----	-----	-----	-----	-----	
<b>Diagnostic</b>										
OTC	000056:- 46:13	000056:- 46:13	000056:- 46:13	000056:- 46:13	000056:- 46:13	000056:- 46:13	000056:- 46:13	000056:- 46:13	000056:- 46:13	
OTM	000056:- 46:13	000056:- 46:13	000056:- 46:13	000056:- 46:13	000056:- 46:13	000056:- 46:13	000056:- 46:13	000056:- 46:13	000056:- 46:13	
DC Voltage	315 V	315 V	315 V	315 V	315 V	315 V	315 V	315 V	315 V	
Heatsink	28.8 °C	28.8 °C	28.8 °C	28.8 °C	28.8 °C	28.8 °C	28.8 °C	28.8 °C	28.8 °C	
Capacitor	29.5	29.5	29.5	29.5	29.5	29.5	29.5	29.5	29.5	
EMV-Filter	29.5	29.5	29.5	29.5	29.5	29.5	29.5	29.5	29.5	
E1-Temp.	20.0 °C	20.0 °C	20.0 °C	20.0 °C	20.0 °C	20.0 °C	20.0 °C	20.0 °C	20.0 °C	

Mode	1.01	2.01 2.03 2.04	2.02	2.05	3.01 3.02	3.03 3.04	4.01 4.02 4.03	5.01 5.02	6.01	User Setting
	Factory setting									
E1-Current	0.00 mA	0.00 mA	0.00 mA	0.00 mA	0.00 mA	0.00 mA	0.00 mA	0.00 mA	0.00 mA	
E1-Voltage	0.00 V	0.00 V	0.00 V	0.00 V	0.00 V	0.00 V	0.00 V	0.00 V	0.00 V	
E2-KTY	20.0 °C	20.0 °C	20.0 °C	20.0 °C	20.0 °C	20.0 °C	20.0 °C	20.0 °C	20.0 °C	
E2-Current	0.00 mA	0.00 mA	0.00 mA	0.00 mA	0.00 mA	0.00 mA	0.00 mA	0.00 mA	0.00 mA	
E2-Voltage	0.00 V	0.00 V	0.00 V	0.00 V	0.00 V	0.00 V	0.00 V	0.00 V	0.00 V	
E3*	0.00 V	0.00 V	0.00 V	0.00 V	0.00 V	0.00 V	0.00 V	0.00 V	0.00 V	
D1	ON	ON	ON	ON	ON	ON	ON	ON	ON	
D2	ON	ON	ON	ON	ON	ON	ON	ON	ON	
D3*	ON	ON	ON	ON	ON	ON	ON	ON	ON	
D4*	ON	ON	ON	ON	ON	ON	ON	ON	ON	
D5*	ON	ON	ON	ON	ON	ON	ON	ON	ON	
K1	OFF	OFF	OFF	OFF	OFF	OFF	OFF	OFF	OFF	
K2	ON	ON	ON	ON	ON	ON	ON	ON	ON	
K3*	OFF	OFF	OFF	OFF	OFF	OFF	OFF	OFF	OFF	
K4*	OFF	OFF	OFF	OFF	OFF	OFF	OFF	OFF	OFF	

\* IO option Add-on module type Z-Modul-B

## 10.2 Possible allocation of the IOs, PINs

### Analog outputs A / A2

Function	Description function A / A2
1A	Constant voltage +10 V
2A	proportional level control
3A	proportional input E1
4A	proportional input E2
5A	Group control
6A	only 2.03 Cooling function (not for Z-Modul-B)
7A	only 2.03 Heating function (not for Z-Modul-B)

### Digital inputs D1..D5

Function	Description function D1..D5
OFF	No function (factory setting)
1D	Enable (remote control) "ON" / "OFF"
2D	External error
3D	"Limit" ON / OFF
4D	Switch over "E1" / "E2"
	<b>For mode speed controller 1.01</b>
5D	Switch over "Setpoint Intern1" / "Setpoint Intern2"
6D	Switch over "Intern" / "Extern"
	<b>For modes as controller higher 2.01</b>
5D	Switch over "Setpoint1" / "Setpoint2"
6D	Switch over "Intern" / "Extern"
7D	Switch over "automatic control" / "Speed manual"
8D	Switch over control function (e.g. "heating" / "cooling")

Function	Description function D1..D5
10D	“Reset”
11D	Setting Max. Speed “ON” / “OFF”
12D	Motorheating ON / OFF (not Acontrol)
13D	Switch over direction of rotation “clockwise” / “counterclockwise” (only frequency inverter with 3 ~ output)
14D	“Freeze function” = maintain momentary modulation value

### Analog inputs E2 / E3

Function	Description Function E2
1E	external Setpoint
2E	external manual mode
3E	Sensor average to E1
4E	Sensor comparison to E1
5E	Sensor difference to E1
6E	Sensor for Setpoint
7E	Measurement
Function	Description Function E3
1E	0 - 10 V external Setpoint
2E	External Manual mode

### Digital outputs K1..K4

Function	Description function K1, K2 ,K3*, K4*
OFF	No function Relays remain always de-energized
1K	Operating indication (factory setting for “K1”, non inverting). Operation without fault, reports enable “OFF”
2K	Fault indication (factory setting for “K2”, non inverting). Energized for operation without fault, for enable “OFF” not energized. De-energized at line, motor and controller fault, Sensor fault dependent on programming, external fault at digital input.
3K	External fault separate with message at digital input (factory setting if terminals bridged)
4K	Limit modulation Over or falling below limits for modulation
5K	Limit “E1” When over or falling below limits for input signal “E1”
6K	Limit “E2” When over or falling below limits for input signal “E2”
	<b>For modes as controller higher 2.01</b>
7K	Setpoint Offset Deviation between actual value and setpoint to high
8K	Group control Switching on fans depending on modulation
	<b>For modes as temperature controller with additional functions 2.03</b>
9K	Heating function Switch ON point: temperature = Setpoint +/- Offset Switch OFF point: Temperature around hysteresis over switch ON point
10K	Cooling function Switch ON point: temperature = Setpoint +/- Offset Switch OFF point: Temperature around hysteresis below switch ON point









**Limits GW E1, GW E2**



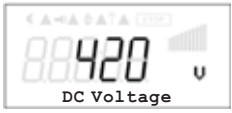







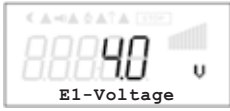

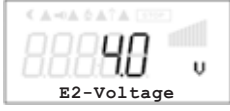
Function	Description function GW E1, GW E2
OFF	without function
1L	Indication with the centralized fault of a programmed relay (IO allocation Function <span style="border: 1px solid black; padding: 0 2px;">2K</span> ). Warning symbol in display, "AL" code in events memory.
2L	Is merely displayed in the events menu as message "msg".

**PINs**

PIN	Function
PIN 0010	Opening service menu, if PIN-protection activated
PIN 1234	Opening "setting". if "set protection" = "ON" (⌂ Controller Setup)
PIN 9090	Restore user setting
PIN 9091	Save user setting (corresponds function "Save user setup" = "ON" ⌂ Controller Setup)
PIN 9095	Restore factory setting = delivery status

**11 Diagnostics menu**

	The diagnostics menu supplies information about the momentary operating condition of the device.
	<b>O</b> = Operation, <b>T</b> = Time, <b>C</b> = Controller The time counting runs, as soon as mains voltage is connected (without fault). If events step on (Motor fault, External Error, etc.), the period of operation is stored at this time (⌂ Events).
	<b>O</b> = Operation, <b>T</b> = Time, <b>M</b> = Motor The time counting runs as soon as a modulation of the controller is present
	ZK voltage constant at approx. 420 V The PFC (Power Factor Controller) makes it mostly independent of the mains voltage.
	Display of the internal temperature of the power semiconductor. During impermissibly high levels (at 75 °C), the output power is automatically reduced. At 90 °C switch off.
	Display of DCLink Elco temperature. During impermissibly high levels (from 75 °C on), the output power is automatically reduced. At 90 °C switch off.
	Display of sine filter choke temperature. In case of temperature increase above predetermined threshold value the modulation is switched off. Restart when cooled down!
	Signal height at analog input E1 (Analog In 1)
	





	
	
	Signal height at analog input E2 (Analog In 2)
	
	
	Status digital input 1 (Digital In 1) OFF = terminals D1 - D1 bridged ↔ ON = terminals D1 - D1 not bridged
	Status digital input 2 (Digital In 2) OFF = terminals D2 - D2 bridged ↔ ON = terminals D2 - D2 not bridged
	Status digital input 3 (Digital In 3*) OFF = terminals D3 - GND bridged ↔ ON = terminals D3 - GND not bridged
	Status digital input 4 (Digital In 4*) OFF = terminals D4 - GND bridged ↔ ON = terminals D4 - GND not bridged
	Status digital input 5 (Digital In 5*) OFF = terminals D5 - GND bridged ↔ ON = terminals D5 - GND not bridged
	OFF = relay K1 de-energized: terminals 11 - 12 bridged ON = relay K1 energized: terminals 11 - 14 bridged
	OFF = relay K2 de-energized: terminals 21 - 22 bridged ON = relay K2 energized: terminals 21 - 24 bridged
	OFF = relay K3* de-energized: terminals 31 - 32 bridged ON = relay K3* energized: terminals 31 - 34 bridged
	OFF = relay K4* de-energized: terminals 41 - 42 bridged ON = relay K4* energized: terminals 41 - 44 bridged

\* When operating together with the “Z-Modul-B” type expansion module, the diagnosis menu is automatically expanded to include the additional inputs and outputs.



## 12 Events / Fault signals

### 12.1 Display and query of events and malfunctions

 <p>Events</p>	<p>Events during operation can lead to a malfunctioning of the device. The last 10 (0 - 9) events and malfunctions are stored in the “Events” menu group (position “0” = most recent event).</p>
<p>Essemples for possible events</p>	<p>The device differentiates between 3 types of events:</p>
 <p>Sensor 1</p>	<p>1. Messages with code <b>[Msg]</b> Message sensor fault for information, for Alarm sensor deactivated.</p>
 <p>External error</p>	<p>2. Alarms with code <b>[AL]</b> Events during which the device automatically restarts operation after the cause of the malfunction has been remedied (e.g. mains failure), or remains in operation (e.g. externally-trunked centralized fault).</p>
 <p>Motor fault</p>	<p>3. Error with code <b>[Err]</b> Events that lead to a disconnection of the controlled output (e.g. excess motor temperature). Restarting is only possible after a reset (locked).</p>



Controllers period of operation at time of message:  
With the **P** key can be switched between description of the message and the Controllers period of operation at this time.  
E.G. on place 3 which is past message **motor fault**.



### 12.2 Messages and trouble shooting



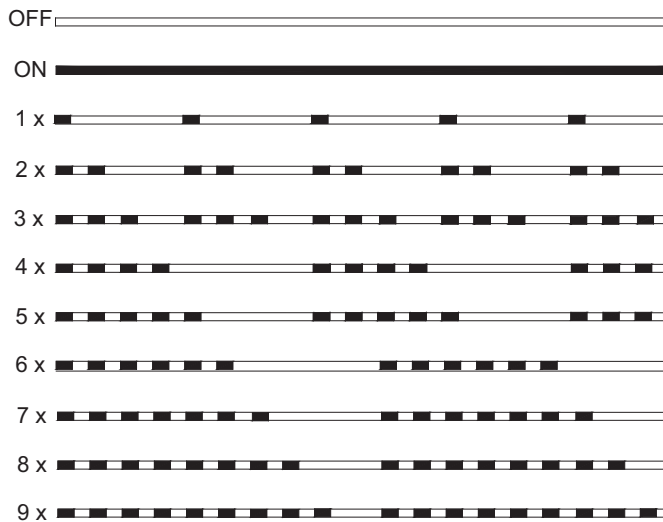

A momentary pending alarm or error message is indicated by a blinking indicator and appears alternately with the standard display.

Operating conditions are indicated by the internal status LED with flashing code.  
internal State LED

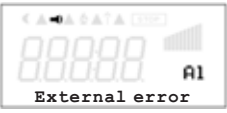

11.02.2009  
v\_flash\_explain.VSD

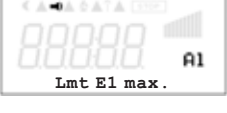
Display	Code*	LED Code	Relais switches**		Cause	Reaction of Controller
			internal	Operation		
		OFF				Adjustment Line voltage available? Unit switches OFF and automatically ON when the voltage has been restored
		1		X	No enable	Switch OFF by external contact (function [1D] = enable programmed for Digital In)
	AL	-	-	-	fault in Eprom	works with defaults
	AL	-	-	X	fault EEP damaged	works with defaults
	AL	-		X	EEP data incorrectly	controller runs with the read settings
 	AL	3		X	The device has integrated temperature monitoring to protect the device from damage caused by excessively high interior temperatures. In case of a temperature increase above the predetermined threshold value (for capacitors 75 °C and heat sink 90 °C ) the level-control is linearly reduced. To prevent a shut down during reduced operation by to high temperature of the entire system (in this operating mode, allowable for the controller), no switch off and no alarm indication "Overload occurs." (☞ "Setting Derating Alarm")	At sinking temperature the controller restarts. Check the temperature in the device via diagnostic menu. Check cooling of the controller
	AL			X	Sine filter to hot	Switch OFF at 150 °C, switch ON when cooled down to 70 °C. Check temperature in controller, Check cooling of the controller
	AL	5	X	X	The controller was switched off by the current limitation. Switch back time: 60 sec	Controller turns the motor off. There is a renewed attempt to start after about one minute. Check motor and brake function
	Err	2	X	X	A connected thermostat or thermistor has tripped the circuit or interruption between both terminals "TB/TP" or "TK/PTC"	The unit then remains switched off. A programmed operating and fault-indicating relay is triggering Check motor and connection then reset

Display	Code*	LED Code	Relais switches**		Cause	Reaction of Controller
			Operation	Fault		Adjustment
	AL		-	selectable	Alarm from external contact	Device continues working unchanged check contacts
	AL	-	-	selectable	Limit indication minimum Actual value below setting "Alarm Minimum" (Input "E1")	Device continues working unchanged
	AL	-	-	selectable	Limit indication maximum Actual value above setting "Alarm Maximum" (Input "E1")	Check setting and sensor
	Msg or AL*	6	selectable	selectable	Interruption / short circuit in the sensor leads or sensor values measured are outside measuring range	The device works with minimal or maximum modulation depending on whether there is a short-circuit or an interruption, and on the programmed mode of operation. Check sensor
*Code: Err = Error AI = Alarm Msg = Message ** Relais switches dependent on programmed function						

### 13 Function extension and version of software

Software D2327A, display version  menu group Start under Fcontrol		
Version	Date	Function from new version
2.35	21.12.2010	first edition

## 14 Enclosure

### 14.1 Technical data

The name plate data for the rated current\* output refer to a maximum ambient temperature of 40 °C. For higher temperatures note following position for operation with higher ambient temperature.

Type	edfc 1/3/6	
Part.-No.	444177 (308198-30)	
Rated current output* {1}	[A]	6
Rated current input {1}	[A]	10
Max. load limit integral of cut-in current {1}	[A <sup>2</sup> s]	18.7
Max. leakage current according to the defined networks of DIN EN 60990	[mA]	7
Max. line fuse {2}	[A]	10
Max. heat dissipation approx. {1}	[W]	210
Noise approx. {3}	[dB]	54.6
Weight	[kg]	6.6

{1} At line voltage 230 V / 50 Hz (cos φ 0.8 Output), data for deviating line voltages on request

{2} Max. supply side line fuse according to DIN EN 60204-1 classification VDE0113 chapter 1.

{3} Sound power level A-weighted by internal fan (- no indication)

Line voltage*	1 ~ 208...277 V (-10...+10 %), 50/60 Hz
Maximal output voltage	3 ~ 250 V The PFC (Power Factor Controller) makes it mostly independent of the mains voltage.
Maximal output frequency	150 Hz
Clock frequency	16 kHz
Power factor	> 0.9
Input resistance for sensor or signal set for the rotational speed	for 0 - 10 V input: R <sub>i</sub> > 100 kΩ for 4 - 20 mA input: R <sub>i</sub> = 100 Ω
Voltage supply e.g. for sensors	+24 V ± 20 %, I <sub>max</sub> 120 mA (for connection to an external AXG terminal minus approx. 50 mA)
Heat dissipation in standby operation	approx. 6.5 W
Output (0 - 10 V)	I <sub>max</sub> 10 mA (short-circuit-proof)
Max. contact rating of the internal relay	2 A / 250 VAC
Max. permissible ambient temperature	40 °C (up to 55 °C with derating)
Min. permissible ambient temperature	0 °C (if mains voltage is not switched off up to -20 °C)
Max. permissible installation height	0...4000 m amsl above 1000 m amsl the rated current is to be reduced by 5 % / 1000 m
Permissible rel. humidity	85 % no condensation
Electromagnetic compatibility for the standard voltage 230 / 400 V according to DIN IEC 60038	Interference emission EN 61000-6-3 (domestic household applications)
	Interference immunity EN 61000-6-2 (industrial applications)
Harmonics current according	Active power factor adjustment for sinusoidal input current (PFC = Power Factor controller), harmonic current in accordance with EN 61000-3-2 are guaranteed
Vibratory strength (for vertical installation, i.e. cable inlet down).	Broadband noise (simulated life-endurance test) in accordance with EN 61373, category 1 class B Shock test according to EN 61373, category 1
Housing protection	IP 54

\* Regarding the mains connection, the Fcontrol devices are to be classified as category "C2" devices according to the relevant DIN EN 61800-2 The increased requirements placed on electrical interference for category "C1" devices are complied with in addition.

**14.1.1 Performance reduction during elevated ambient temperatures**

A load with the rated current stated in the type code is fundamentally feasible up to an ambient temperature of 40 °C. The fact that the power loss accruing in the device increases with increasing mains voltage and with the special setting adjusted to “Edge frequency” > “maximum frequency” applies in general.

**Performance reduction during elevated ambient temperatures**

As the dissipation of the power loss (heat generation) arising in the device depends crucially on the ambient temperature, the max. load must definitely be reduced in cases where the ambient temperatures exceed 40 °C! The average value measured during a 24 h period must be 5 K under the max. ambient temperature. For installation in a switch cabinet, the device’s dissipation and its possible affect on the ambient temperature must be taken into consideration! In addition, during ambient temperatures above 40 °C, the maximum permissible load for each type depends on the applied mains voltage and the “Edge frequency” and “Maximum frequency” settings (Settings U/f curve in the “Motor Setup”).

In the case of special settings with “Edge frequency” > “Maximum frequency”, due to higher power losses it is possible that automatic power reduction, “derating”, occurs.

**Maximum load for ambient temperatures higher 40 °C (for line voltage 1 ~ 230 V)**

Type	Part.-No.	max. load current			
		@ 40 °C [A]	@ 45 °C [A]	@ 50 °C [A]	@ 55 °C [A]
edfc 1/3/6	444177 (308198-30)	6.0	5.8	5.2	4.5

For line voltage < 208 V due to higher power losses it is possible that automatic power reduction, “derating”, occurs.

### 14.2 Connection diagram

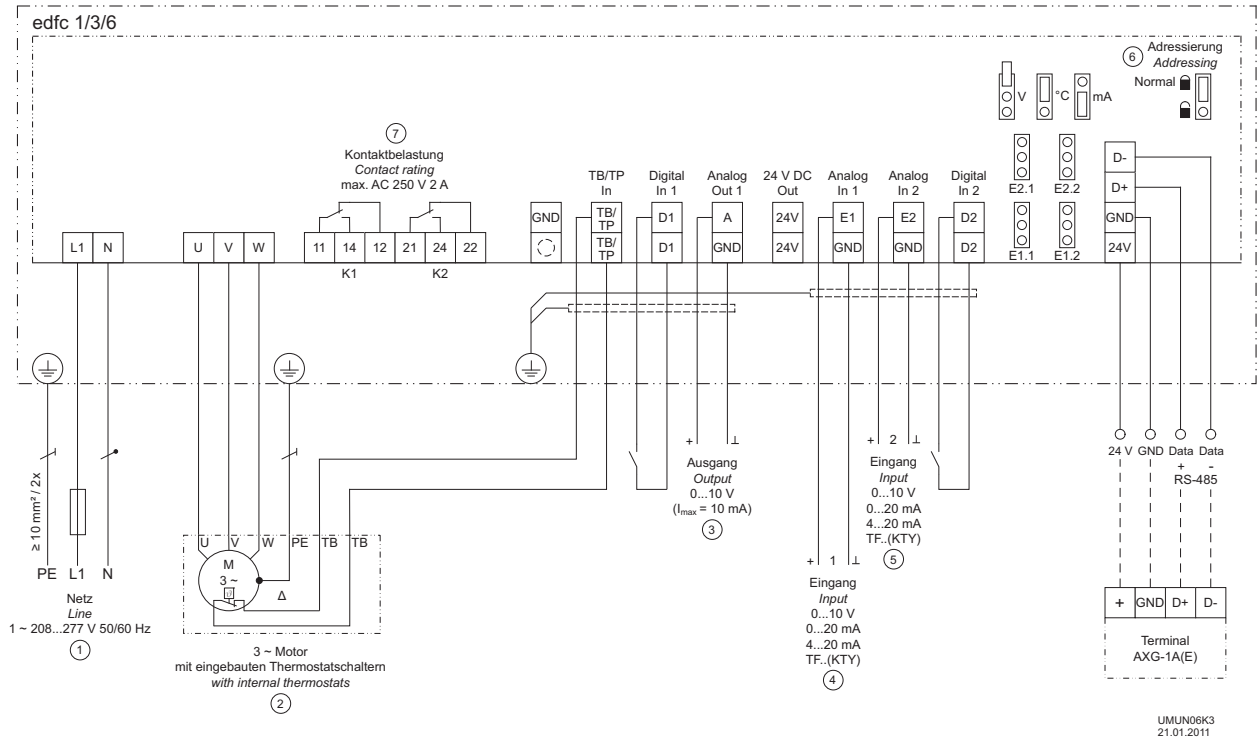

- 1 Line 1 ~ 208...277 V, 50/60 Hz
- 2 3 ~ Motor with internal thermostats
- 3 Output 0...10 V ( $I_{max} = 10 \text{ mA}$ )
- 4 Input 1: 0...10 V, 0...20 mA, 4...20 mA, TF..(KTY)
- 5 Input 2: 0...10 V, 0...20 mA, 4...20 mA, TF.. (KTY)
- 6 Addressing, normal lock closed
- 7 Contact rating max. 2A / 250 V AC

### 14.3 Dimensions [mm]

edfc 1/3/6

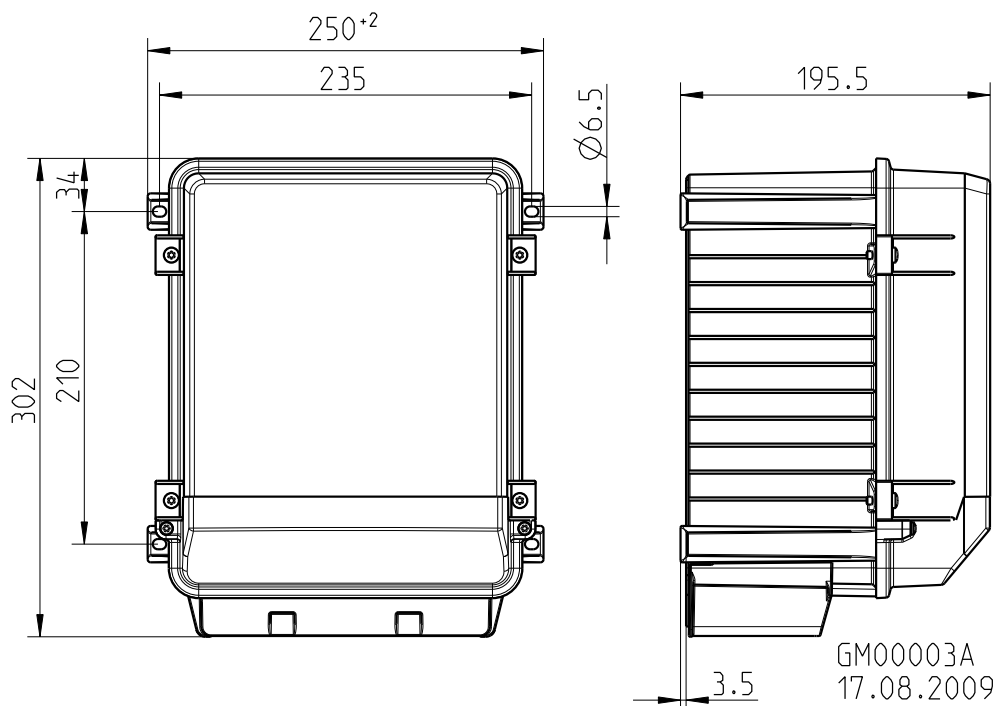

## The **Vent-Axia** Guarantee

Applicable only to products installed and used in the United Kingdom. For details of guarantee outside the United Kingdom contact your local supplier.

Vent-Axia guarantees its products for two years from date of purchase against faulty material or workmanship. In the event of any part being found to be defective, the product will be repaired, or at the Company's option replaced, without charge, provided that the product:-

- Has been installed and used in accordance with the instructions given with each unit.
- Has not been connected to an unsuitable electricity supply. (The correct electricity supply voltage is shown on the product rating label attached to the unit).
- Has not been subjected to misuse, neglect or damage.
- Has not been modified or repaired by any person not authorised by the company.

### IF CLAIMING UNDER TERMS OF GUARANTEE

Please return the complete product, carriage paid to your original supplier or nearest Vent-Axia Centre, by post or personal visit. Please ensure that it is adequately packed and accompanied by a letter clearly marked "Guarantee Claim" stating the nature of the fault and providing evidence of date and source of purchase.

The guarantee is offered to you as an extra benefit, and does not effect your legal rights

## **Vent-Axia**

Head Office: Fleming Way, Crawley, West Sussex, RH10 9YX. Tel: 01293 526062 Fax: 01293 551188

SALES ENQUIRIES:  
TECHNICAL SUPPORT:  
Web:-[www.vent-axia.com](http://www.vent-axia.com)

**UK NATIONAL CALL CENTRE**, Newton Road, Crawley, West Sussex, RH10 9JA  
Tel: 0844 8560590 Fax: 01293 565169  
Tel: 0844 8560594 Fax: 01293 539209  
Email:- [info@vent-axia.com](mailto:info@vent-axia.com)

As part of the policy of continuous product improvement Vent-Axia reserves the right to alter specifications without notice.